

DACIA



**VEHICLE
USER
MANUAL**

DUSTER



Welcome aboard your vehicle

This user manual contains the information required:

- for you to familiarise yourself with your vehicle, to use it to its best advantage and to fully benefit from all the functions and the technical developments it incorporates.
- to ensure that it always gives the best performance by following the simple, but comprehensive advice concerning regular maintenance.
- to enable you to deal quickly with minor faults not requiring specialist attention.

It is well worth taking a few minutes to read this manual to familiarise yourself with the information and guidelines it contains about the vehicle and its functions and new features. If certain points are still unclear, our Network technicians will be only too pleased to provide you with any additional information.

For guidance, please see the following symbols:

 and  Visible on the vehicle, they show that you should consult the manual to find detailed information and/or limits on operations in respect of equipment on your vehicle.

→ anywhere in the manual indicates a transfer to a page.



anywhere in the manual indicates a hazard, danger or a safety recommendation.

The description of the models given in this manual is based on the technical specifications at the time of writing. **The manual covers all items of equipment (both standard and optional) available for these models, but whether or not these are fitted to the vehicle depends on the version, the options selected and the country where the vehicle is sold.**

This manual may also contain information about items of equipment to be introduced later in the model year.

The diagrams in the user manual are provided as examples only.

Enjoy driving your new vehicle.

Translated from French. Copying or translation, in part or in full, is forbidden unless prior written permission has been obtained from the car manufacturer.

CONTENTS

Welcome aboard your vehicle	4	Lighting and signals	126
Exterior	4	Audible and visual signals	131
Passenger compartment	6	Wiper	132
Driver's position	8	Fuel tank	138
Driving aids	10	Reagent tank	144
Safety on board	12	Driving	148
Identifying a vehicle - Labels	14	Running in	148
The engine compartment (routine maintenance)	16	Starting, stopping the engine	149
Breakdown recovery	18	Gear control	159
The LPG vehicle	20	Special features of Diesel versions	165
The Hybrid vehicle	22	Special features of petrol versions	167
Getting to know your vehicle	24	Parking brake	169
Vehicle HYBRID	24	Environment	174
Vehicle MILD HYBRID	30	Maintenance and antipollution advice	176
LPG vehicle	32	Driving advice, eco-driving	177
Card	35	Tyre pressure loss warning	183
Key, remote control	43	Transmission: 4-wheel drive	189
Doors and opening elements	48	Driver correction devices and aids	195
Front seats	54	Additional driving aid functions	200
Rear seats	57	Speed limiter	234
Seat belts	59	Cruise control	237
Additional safety devices	63	Stop and Go adaptive cruise control	240
Child safety	73	Parking aids	252
Child seats	79	Emergency call	266
Child safety: deactivating, activating the front passenger airbag	90	Your comfort	269
Driving position	93	Air vents, heating and air conditioning	269
Trip computer	98	Multimedia equipment	283
Warning lights	116	Passenger compartment equipment	288
Steering	122	Passenger compartment storage, fittings	294
Rear view mirrors	124	Transporting objects	300

CONTENTS

Maintenance	307
Accessing the engine, levels	307
Battery	316
Cleaning.....	320
Practical advice.....	324
Tyres	324
Breakdown recovery	339
Headlights, lights: replacing bulbs	346
Wiper blades: replacement.....	357
Fuses	359
Fitting a radio	364
Installation and use of accessories.....	365
Operating faults	367
Technical specifications	372
Information about the vehicle	372
Replacement parts and repairs	381
Service sheets	382
Anticorrosion check	388

EXTERIOR

1

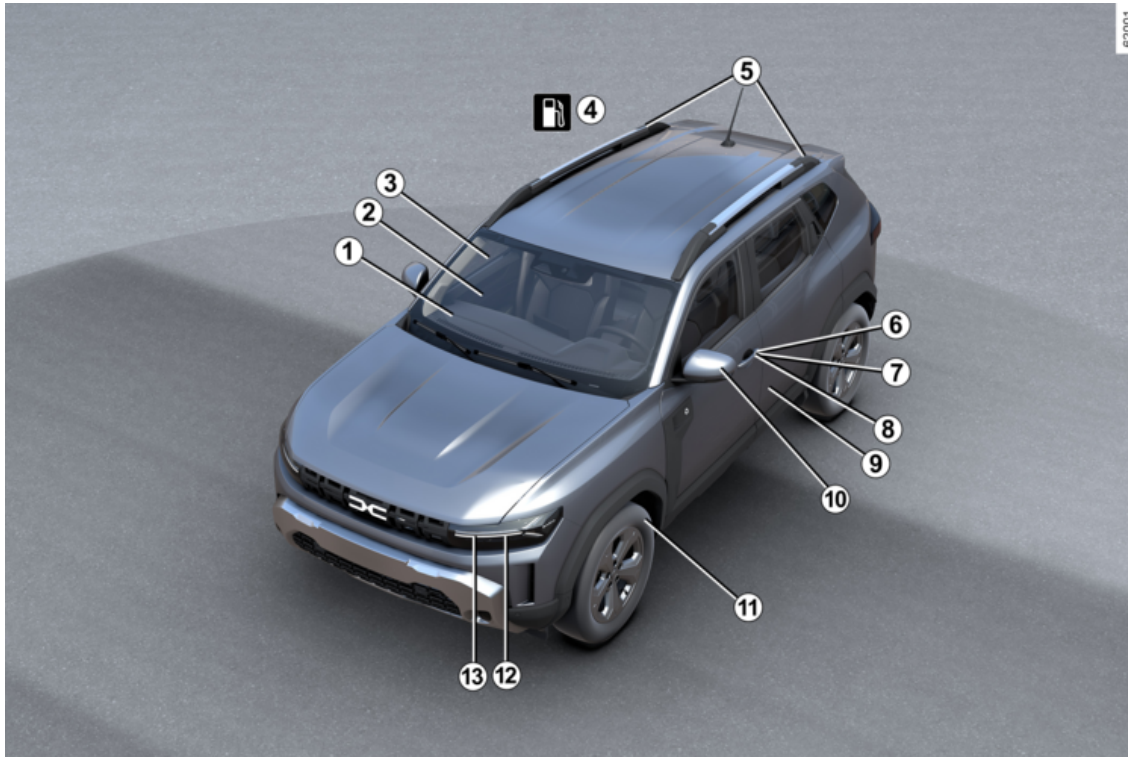

EXTERIOR

- 1** Demisting → **273** and → **277**
- 2** Windscreen wiper(s) → **132**
- 3** Electric windows → **288**
- 4** Filling up with fuel/LPG → **138**
- 5** Roof bars → **303**
- 6** Key/remote control → **43**
- 7** → **35** card
- 8** Locking/unlocking the doors → **49**
- 9** Bodywork maintenance → **320**
- 10** Rear view mirrors → **124**
- 11** Tyres → **324**
- 12** Lights: operation → **126**
- 13** Lights: replacement → **346**

PASSENGER COMPARTMENT

1

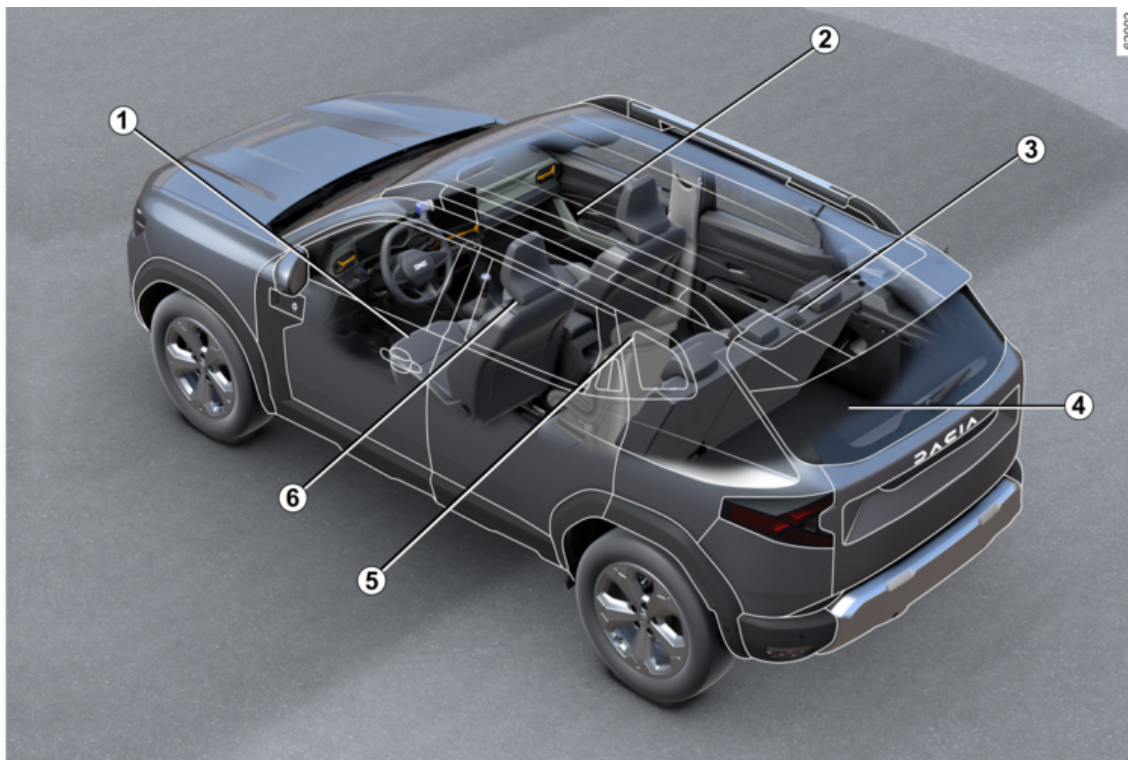

PASSENGER COMPARTMENT

- 1** Adjusting your driving position → **59**
- 2** Passenger compartment storage/features → **294**
- 3** Rear bench seat → **57**
- Rear headrests → **57**
- 4** Luggage compartment storage/fittings → **300**
- 5** Child safety → **73**
- 6** Front seats → **54**
- Front headrests → **54**

DRIVER'S POSITION

1

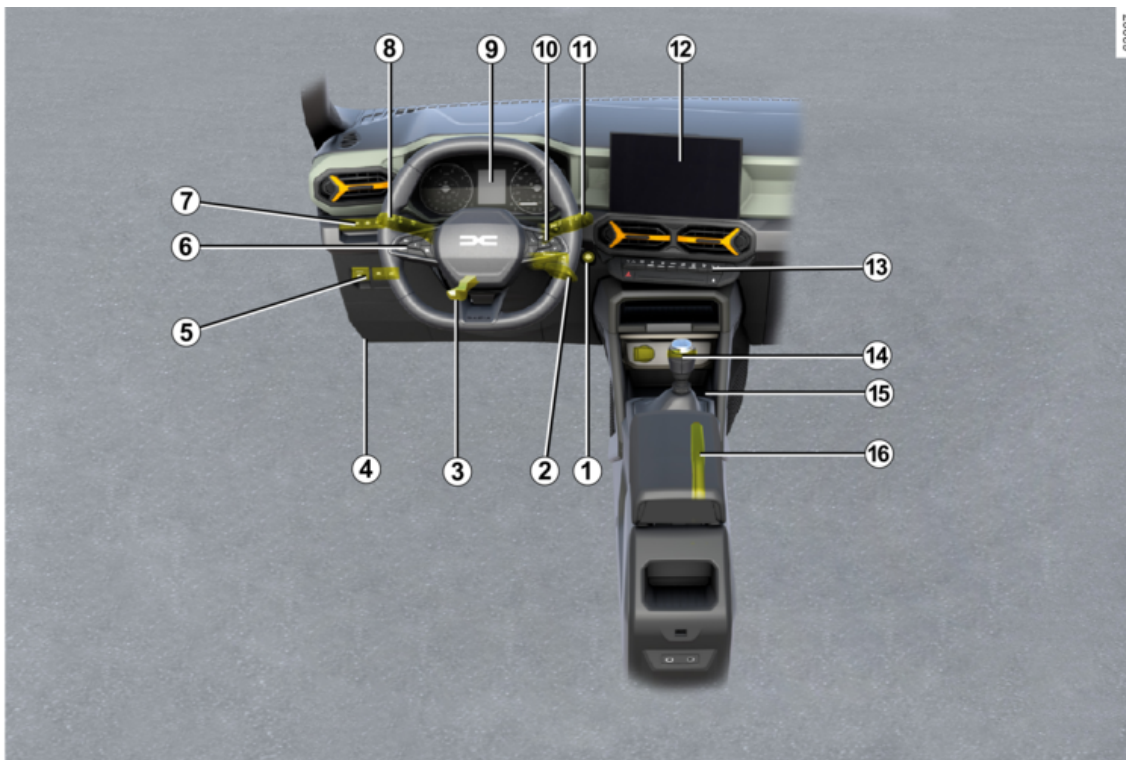

DRIVER'S POSITION

1 Engine start/stop button → 151

2 Key ignition switch → 149

3 Steering wheel adjustment → 122

4 Bonnet release → 307

5 LPG Command → 32

Electronic parking brake → 169

6 Speed limiter → 234

Cruise control → 237

Depending on the vehicle, the adaptive cruise control Stop and Go → 240

7 Controls for:

- My Safety → 200 ;
- adjusting the height of the headlights → 129;
- ECO → 177 mode;
- Stop and Start → 155.

8 Exterior lighting → 126

9 Instrument panel → 116

10 Trip computer controls → 98

11 Screen wash/wipe stalk → 132

12 Multimedia screen → 283

13 Heated seat(s) → 54

Heating system/air conditioning → 273

14 Gear lever → 159

15 Telephone charging/storage area → 283

16 Parking brake → 169

DRIVING AIDS

1

62003



DRIVING AIDS

- ABS (anti-lock braking system) → 195
- ESC (electronic stability control) → 195
- Braking assistance → 195
- Hill Start Assist → 195
- Traction control → 195
- Stop and Start → 155
- My Safety → 200
- Lane departure prevention → 201
- Blind spot warning → 209
- Safe distance warning → 214
- Active emergency braking → 218
- Driver vigilance warning → 226
- Road sign detection → 228
- Speed limiter → 234
- Cruise control → 237
- adaptive cruise control Stop and Go → 240
- Park Assist → 252
- Reversing camera → 258
- Multi-view camera → 261
- Tyre pressure loss warning → 183

SAFETY ON BOARD

1

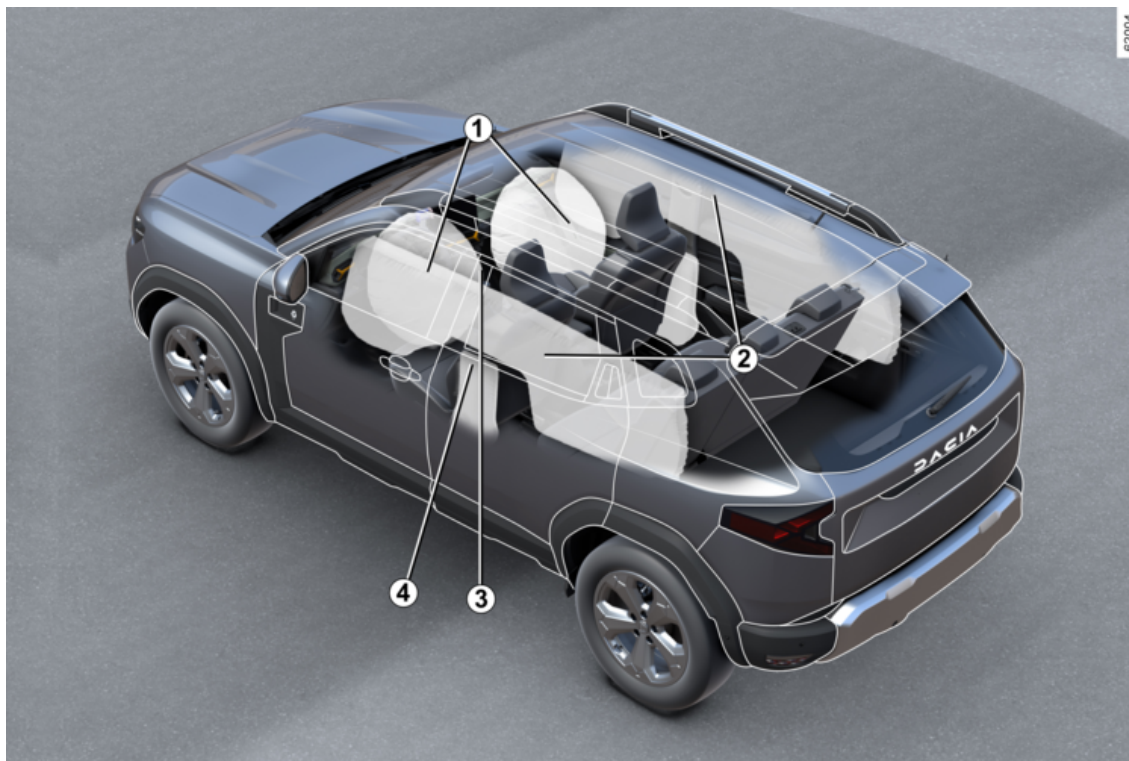

SAFETY ON BOARD

1 Airbags Front → **63**

Frontal passenger airbag inhibition → **90**

2 Airbags Curtain → **69**

3 Seat belts → **59**

4 Airbags side → **68**

IDENTIFYING A VEHICLE - LABELS

1

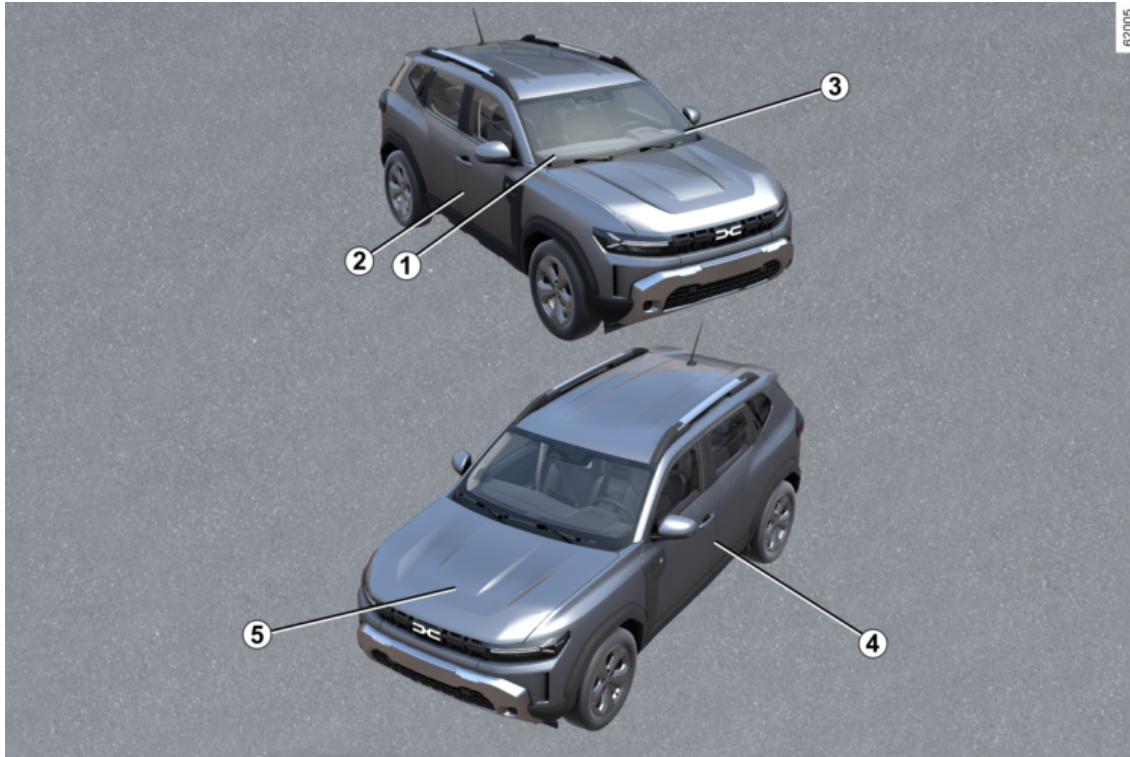

IDENTIFYING A VEHICLE - LABELS

- 1** Technical information for the emergency services → **372**
- 2** Vehicle identification plate → **372**
- 3** Vehicle identification number reminder → **372**
- 4** Tyre pressure labels → **183** → **327**
- 5** Engine identification → **373**

THE ENGINE COMPARTMENT (ROUTINE MAINTENANCE)

1

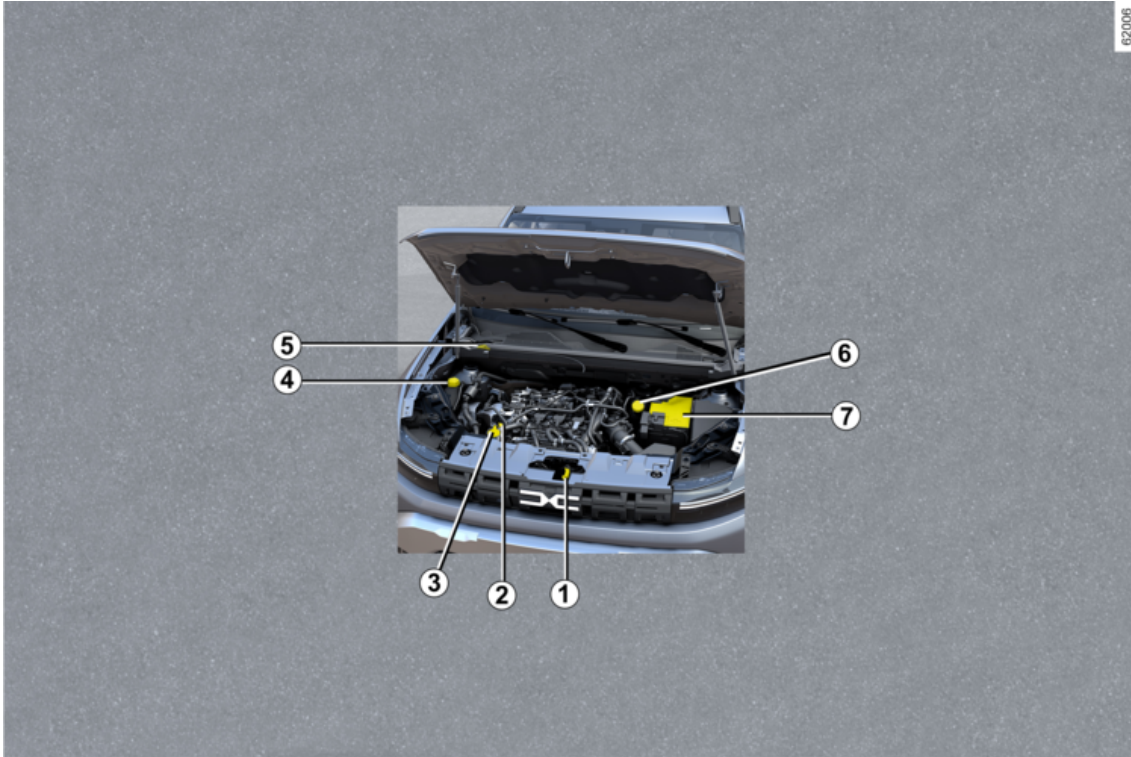

THE ENGINE COMPARTMENT (ROUTINE MAINTENANCE)

- 1** Opening the bonnet → **307**
- 2** Engine oil dipstick → **308**
- 3** Engine oil filler cap → **308**
- 4** Coolant → **312**
- 5** Screen washer fluid → **314**
- 6** Brake fluid → **314**
- 7** → **24** → **316** → **341** battery

BREAKDOWN RECOVERY

1

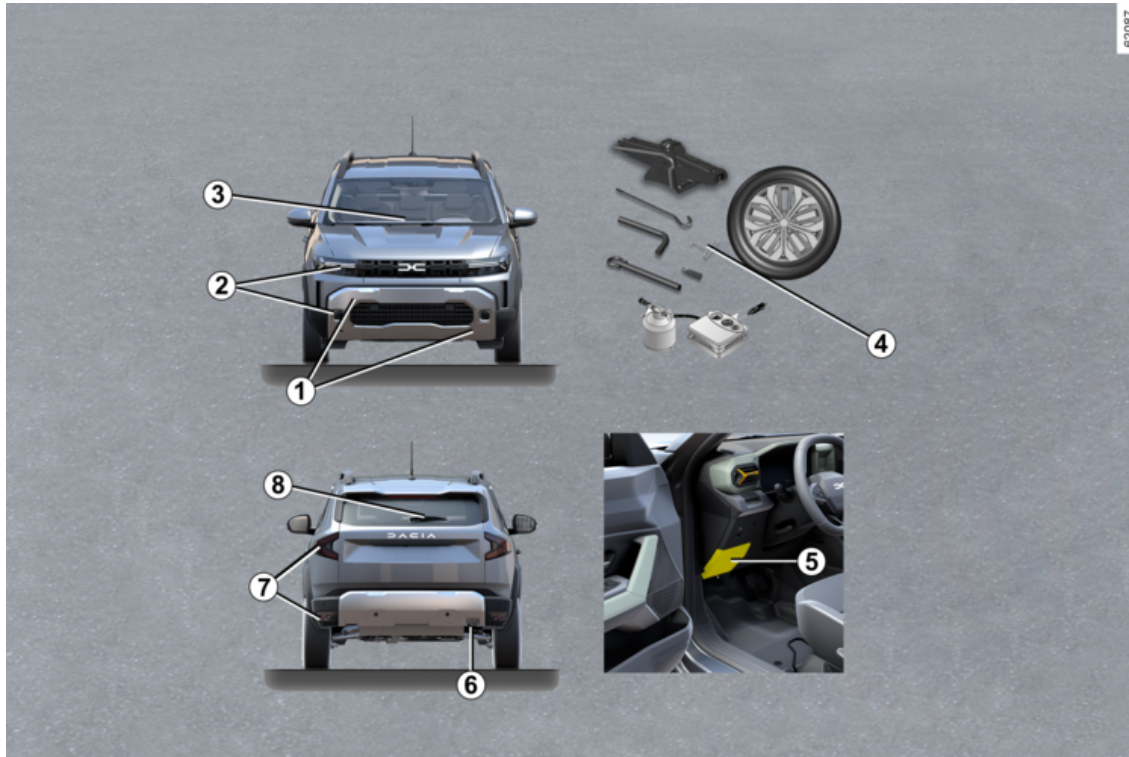

BREAKDOWN RECOVERY

- 1** Front towing point → **339**
- 2** Replacing headlight bulbs → **346**
- 3** Replacing windscreen wiper blade(s) → **357**
- 4** Puncture: tools → **332**
- Emergency spare wheel → **333**
- Changing a wheel → **335**
- 5** Fuses → **359**
- 6** Rear towing point → **339**
- 7** Replacing rear light bulbs → **347**
- 8** Replacing the rear screen wiper blade → **357**

THE LPG VEHICLE

1

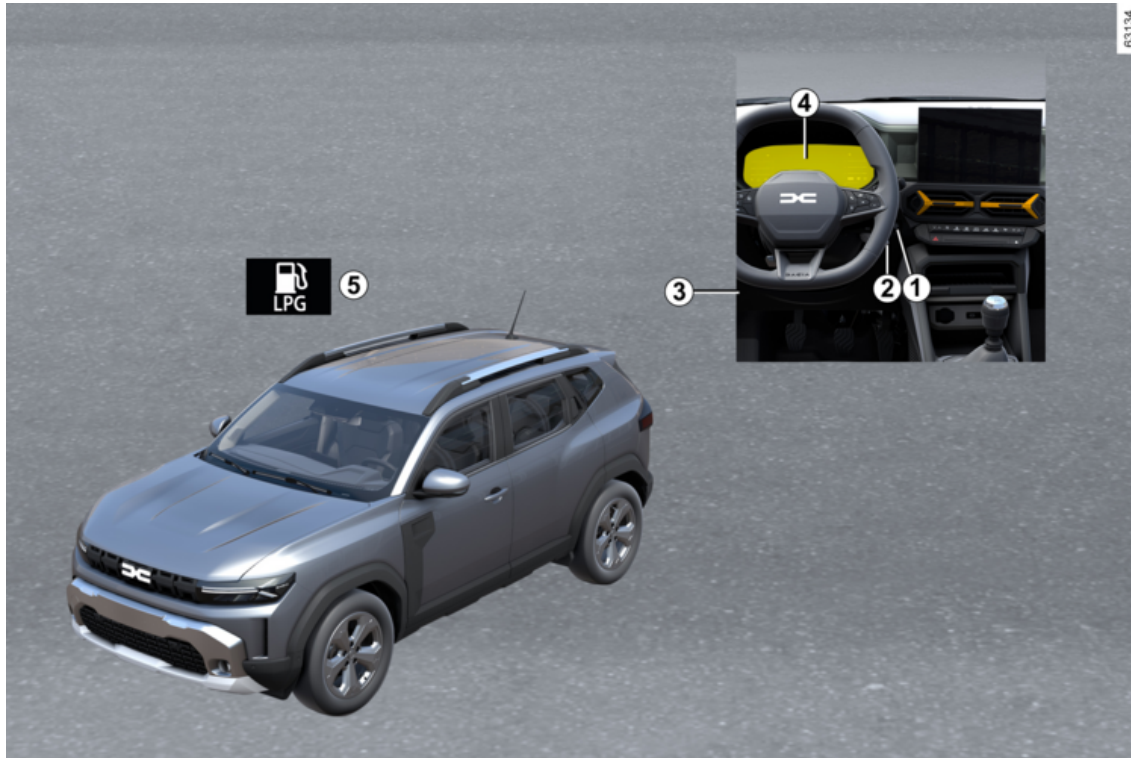

THE LPG VEHICLE

- 1** Starting, stopping the engine: vehicle with key → **149**
- 2** Starting, stopping the engine: vehicle with → **151** card
- 3** LPG Command → **32**
- 4** Trip computer → **98**
- 5** LPG filling → **138**

THE HYBRID VEHICLE

1

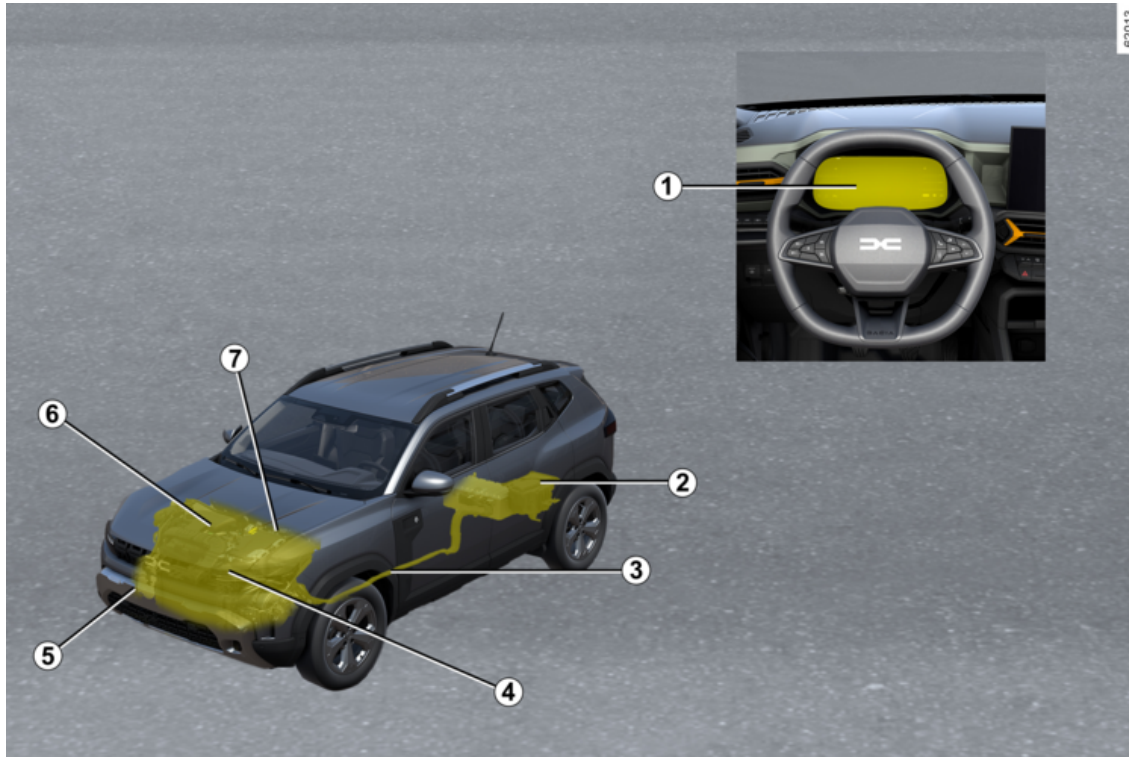

THE HYBRID VEHICLE

Hybrid vehicle system: introduction → 24

Hybrid vehicle system: important recommendations → 29

1 Warning lights → 116

Displays and indicators → 108

Charge meter → 179

2 Battery → 24 → 316 → 317 → 341

3 Orange electrical power cables → 24

4 Electric motor → 24

5 Towing, breakdown recovery → 339

6 Combustion engine → 24

7 Coolant → 312

VEHICLE HYBRID

Introduction

2

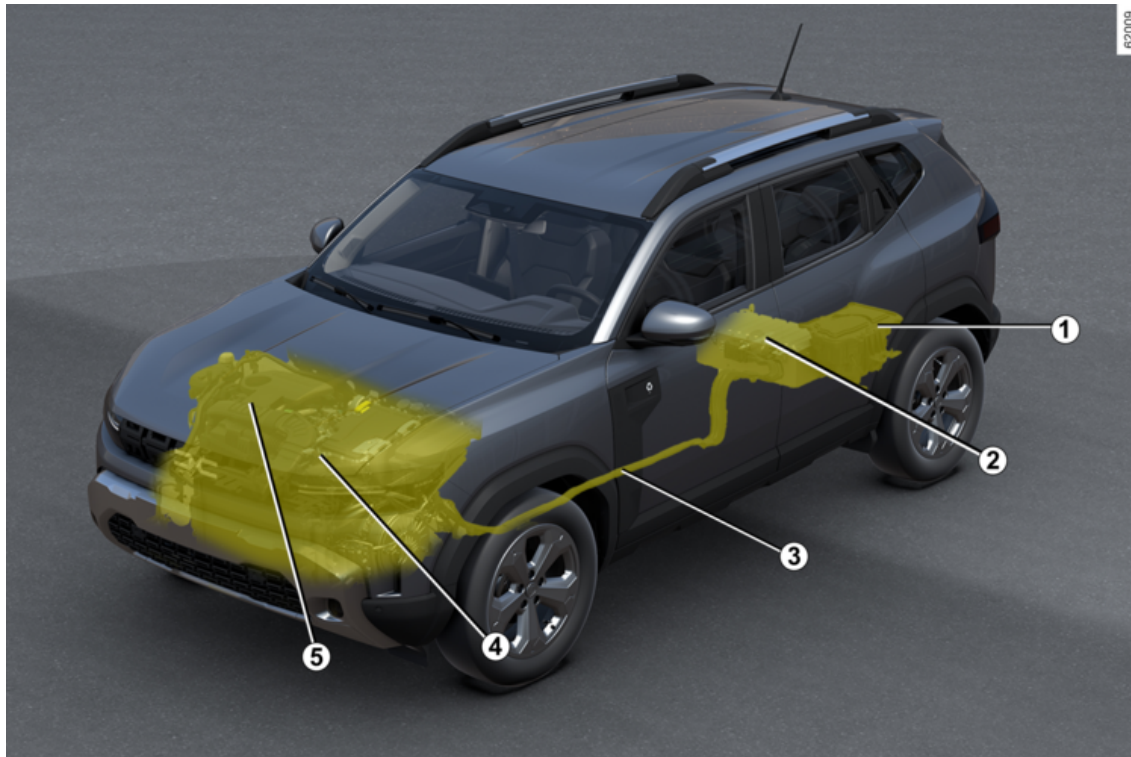

VEHICLE HYBRID

- 1 Secondary "12 V" battery
- 2 "230 volt" traction battery
- 3 Orange electrical power cables
- 4 Electric motor
- 5 Combustion engine

The Hybrid vehicle system uses an electric motor to improve the performance of the combustion engine (acceleration, starting, etc.).

The vehicle has more acceleration torque available while consuming less fuel.

The vehicle may also move in all-electric operating mode without any assistance from the combustion engine. The vehicle uses energy stored in the "230 V" traction battery.

Batteries

The Hybrid vehicle is equipped with two types of battery:

- a "230 V" traction battery;
- a secondary "12 V" battery.

"230 volt" traction battery

This battery, located underneath the rear floor, stores the energy required for the electric motor to operate correctly.

As with any battery, it discharges when it is used. The traction battery is charged:

- during the vehicle deceleration phases;
- when the combustion engine starts automatically in order to act as a generator.

Your vehicle range in electric operating mode depends on the charge level of the traction battery, and also on your driving style and the components consuming energy (air conditioning, heating system etc.).

In the event of traction battery discharge, the combustion engine alone moves the vehicle until the traction battery is sufficiently recharged.

If your vehicle is parked for a long time, start the engine at regular intervals (about once a month) and check

that the  warning light is displayed in blue on the instrument panel. If this happens, the battery needs to be recharged: leave the engine on until the warning light is displayed in blue ➔ 108.

Failure to do so may result in damage to the traction battery and make it impossible to start the vehicle.

Secondary "12 V" battery

The secondary "12 V" battery, located in the luggage compartment, supplies the energy required to open/close the vehicle and to operate the equipment.

Note: the secondary "12 Volts" battery does not participate when the engine is started. This is provided by the Hybrid system.



The Hybrid vehicle electric system uses approximately 230 V DC (direct current).

This system can get hot during and after switching off the ignition. Respect warning messages given on the labels in the vehicle. All operations on or modifications to the "230 V" electrical system (components, cables, connectors, traction battery) are strictly prohibited due to the risks they present to your safety. Call an approved dealer.

The risk of serious burns or electric shocks can lead to death.

VEHICLE HYBRID

A



The **A** symbol identifies the electrical elements in your vehicle which may present safety risks.

61607

"230 V" electrical circuit

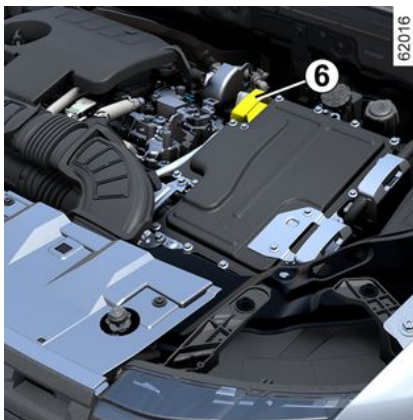

The "230 V" electrical circuit can be recognised by orange cables **6** and parts bearing the  symbol.

Noise

The Hybrid vehicles are particularly quiet in electric operating mode. You will not yet necessarily be used to it, and neither will other road users. It is difficult for them to hear your vehicle when it is moving.

To warn people of your vehicle presence, your vehicle is fitted with a pedestrian horn. In electric operating mode, the system is activated automatically. The sound is emitted when

the vehicle speed is between approximately 1 and 19 mph (1 and 30 km/h).

As the electric motor is silent, you will hear noises that may seem unusual (aerodynamic noises, tyres, etc.) as well as noises due to the operation of the Hybrid system (e.g. cooling of the traction battery).

Pedestrian horn

The pedestrian horn enables you to warn others of your presence – especially pedestrians and cyclists.

When the engine is started, the pedestrian horn is activated automatically. The sound is emitted when the vehicle speed is between approximately 1 and 19 mph (1 and 30 km/h).

In the event of a fault with the pedestrian horn, the "Failure Outside sound" message is displayed on the instrument panel. Consult an approved Dealer.

VEHICLE HYBRID



Your Hybrid vehicle is very quiet. When getting out of the vehicle, always check that the gear selector is in **P** position, apply the parking brake and switch off the ignition.
RISK OF SERIOUS INJURY.

Operation

The Hybrid system selects the combustion engine and/or the electric engine according to the driving style (smooth or sporty driving, etc.) and traffic conditions.

Bad weather, flooded roads:



Do not drive through floods if the depth of water is above the lower edge of the wheel rims.

Energy flow indicator 1

62292



Depending on the driving mode selected, the warning light **1** represents the energy flows between:

- the electrical assembly (traction battery and electric motor);
- the combustion engine;

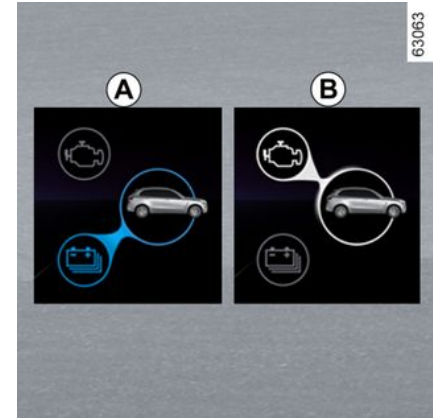

63063

2

The colour of flows varies:

- blue: electrical energy;
- white: energy produced by the combustion engine.

"Electric traction" A flow

The electrical assembly is used to move the vehicle.

"Combustion engine traction" B flow

The combustion engine is used to move the vehicle.

VEHICLE HYBRID

2

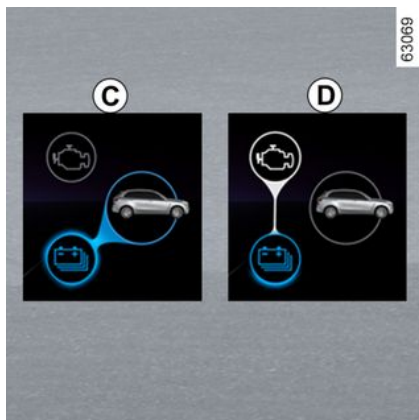

"Energy recovery" C flow

When you lift your foot off the accelerator pedal or when you press on the brake pedal, the electric motor and/or the regenerative braking system convert the energy produced by the vehicle deceleration into electric energy.

This is used to brake the vehicle and recharge the traction battery.

Flow D "Energy production"

The combustion engine recharges the traction battery.

Note: a combination of different flows is possible (e.g. combining flow A and flow B means that the combustion engine and the electric motor are being used to move the vehicle).

 **Special case**
When the traction battery reaches a maximum charge level, the engine brake is temporarily reduced. Please adapt your driving style appropriately.

 The engine brake should under no circumstances be used as a substitute for the brake pedal.

The warning light 2 **EV** is displayed on the instrument panel to inform you that the Hybrid system is using only the electrical assembly to power the vehicle movement.

All-electric driving mode

62294

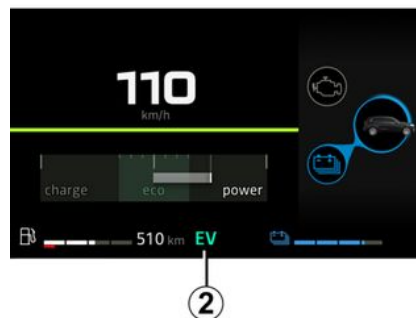

Important recommendations



Please read these instructions carefully. Failure to follow these instructions may lead to **a risk of fire, serious injury or electric shocks which could result in death.**

In the event of an accident or impact

In the event of an accident or an impact to the underside of the vehicle (e.g. striking a post, raised kerb or other street furniture) the electric circuit or the traction battery may be damaged.

Have the vehicle checked by an authorised dealer.

Never touch the "230 V" components or orange cables which are exposed and visible inside or outside the vehicle.

In the event of serious damage to the traction battery, leaks may occur:

- never touch liquids (fluids, etc.), coming from the traction battery;
- in the event of contact with the body, wash the affected area with plenty of water and consult a doctor as soon as possible.

In the event of fire

In the event of a fire, exit and evacuate the vehicle, contact the emergency services and inform them that the vehicle is a Hybrid.

Only use extinguishing agents ABC or BC that are permitted for use with electrical fires. Do not use water or other extinguishing agents.

In the event of damage to the electrical circuit, please call an authorised dealer.

All towing operations

Refer to the paragraph entitled "Towing, breakdown recovery" → 339.

Washing the vehicle

Never wash the engine compartment and "230 V" traction battery using a high-pressure washer.

This risks damaging the electric circuit.

Risk of electric shock and a risk to life.

VEHICLE MILD HYBRID

Introduction

2

The Mild Hybrid system improves engine performance. The vehicle has more acceleration torque available while consuming less fuel.

Secondary "48 V" battery

The Mild Hybrid vehicle is equipped with a secondary "48 V" battery → 318.

Located under the front passenger seat, this battery stores the energy recovered during phases of deceleration. This energy is used by the Mild Hybrid system to provide additional torque to the combustion engine.

If your vehicle is parked for a long time, start the engine at regular intervals (about once a month) for about 15 minutes to recharge the secondary "48 V" battery.

Failure to do so may result in damage to the battery and make it impossible to start the vehicle.

"48 V" electrical circuit

A



The "48 volt" electrical circuit is denoted by yellow cables and parts bearing

the  symbol.

The **A** symbol identifies the electrical elements in your vehicle which may present safety risks.



The secondary battery does not require any maintenance. You should not open it or add any fluid.

Risk of electric shock.

Air vent 1



Ensure that no objects or fluids enter the air vent **1**.

If an object enters the air vent or there is a fluid leakage, please contact an Approved Dealer.

Note: under the front right seat, you may hear ventilation noises while the traction battery cooling system is operating.

If the "48V battery cooling: obstructed under seat grid" message appears on the instrument panel, clear the vent of any obstructions.

If the message persists after the vent is cleared, consult an Approved Dealer.

VEHICLE MILD HYBRID



Take care not to obstruct the air vent **1**.

If the vent is obstructed (e.g. due to an object placed over it), the traction battery may overheat and hinder the performance of the electric motor.

LPG VEHICLE

Special features of LPG versions

These vehicles operate by bi-fuelling using two types of fuel: LPG and petrol.

They have two separate tanks → 138.

What is LPG?



Liquefied petroleum gas that complies with standard EN 589, or the equivalent national regulations.

It can be readily identified by its characteristic smell.



LPG/petrol fuel mode selection control 1

This enables the driver to manually switch from one fuel mode to another.

The **LPG** warning light appears in grey on the instrument panel to indicate that the system is waiting for the required conditions to met before switching to LPG mode.

The warning light **LPG** appears in white or, depending on the vehicle, in green indicating that the LPG mode is activated.



Fuel gauge warning light

The display 2 indicates the level in the LPG tank.

The amount of LPG indicated is an indicative value.

The "LPG low level" message appears

accompanied by the **LPG** warning light in white or, depending on the ve-

hicle, in green and the **LPG** warning light appear on the trip computer 2 accompanied by a beep. This indicates that the tank is almost empty and that the engine is operating using the reserve fuel tank.

Press switch 3 "OK", 4 or 5 to clear the message and the warning lights.

Starting the engine



LPG VEHICLE

The engine is always started using petrol.

- For vehicles with a key ➔ 149.
- For vehicles with a card ➔ 151.

Note: if LPG mode is activated when the engine is started, the system temporarily switches to "Petrol" mode, the

LPG warning light appears in grey without any beep and the display **2** indicates that petrol mode is activated.

As soon as the required conditions are met (engine temperature level, etc.), the system automatically switches to

LPG mode: the **LPG** warning light appears in white or, depending on the vehicle, in green.

Changing fuel while driving

To switch from petrol mode to LPG mode manually

Press control **1**.

The transition to LPG is made during the first acceleration:

- the LPG fuel level is activated on the display **2**;
- the warning light **LPG** comes on in grey to confirm the choice of LPG mode, then comes on in white or, depending on the vehicle, in green when LPG mode is active.

To switch from LPG mode to petrol mode manually

Release the accelerator pedal and press the control **1**.

The **LPG** warning light disappears and the display **2** indicates that Petrol mode is activated.



To access the information and to reset the LPG trip settings ➔ 100.



While the fuel tank is empty, the vehicle cannot start or drive in LPG mode only.

Operation using LPG/petrol bi-fuel requires the presence of petrol (for starting, high acceleration, cold temperatures, etc.).

If the orange  warning light appears on the instrument panel accompanied by a beep, fill the tank with at least 1.76 gal (8 litres) of fuel.

Automatically switching from LPG mode to petrol mode

Depending on the vehicle, under certain conditions of use, the system may opt to temporarily switch back to petrol mode.

The **LPG** warning light appears in grey to warn you.

If the conditions are met again, it then automatically switches back to LPG

mode and the warning light **LPG** comes on in white or, depending on the vehicle, in green.

Note: after several unfruitful attempts, the system may decide to remain in Petrol mode for the current journey. A new attempt may be made after the engine has been stopped completely for about one minute.

LPG tank empty

If there is no more LPG remaining in the tank then the system automatically switches to petrol mode.

This will be indicated by the appearance of the "LPG tank empty" mes-

sage and the  warning light accompanied by a beep.

The warning light **LPG** goes out.

LPG VEHICLE

Fill up with LPG → 138.

Operating faults

In the event of a fault that could impair the correct operation of the engine, the "LPG not available" message appears and the system automatically switches from LPG mode to Petrol mode.

This is confirmed by the appearance of the "Check LPG system" message and

the **LPG!** warning light or, depending

on the vehicle, the **LPG** warning light in yellow on the instrument panel **2**.

Contact your approved Dealer as soon as possible;

If driving under severe conditions

In very cold weather (temperature below approximately 10°C) and depending on the quality of the gas used, the system may automatically manage the conditions for switching between LPG mode and Petrol mode.

Note: on vehicles that are equipped, it is recommended to use ECO mode in these conditions (particularly below 0°C) in order to maximise the use of LPG mode → 177.

In the event of an accident

The main precautions to be taken are the same as with petrol vehicles:

- apply the parking brake;
- stop the engine (a safety device that stops LPG from entering the engine is automatically triggered);
- switch off the ignition;
- observe local regulations.



LPG has a very specific smell so you will be able to detect any leaks easily. If you smell gas in your vehicle or around your vehicle:

- switch to petrol mode immediately and make sure that there are no flames or sources of fire near the vehicle;
- go to an authorised dealer.



Do not touch, hit or dismantle any part of the LPG system components.

CARD

General information

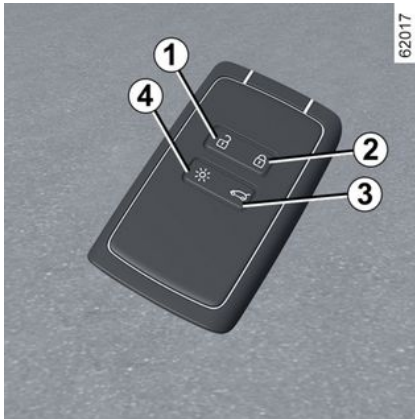

1. Unlocking the doors and luggage compartment.
2. Locks all the opening elements.
3. Unlocking/locking the boot.
4. Switching on the lighting remotely.

The card is used for:

- locking/unlocking the opening elements (doors, luggage compartment door);
- switching on the vehicle lighting remotely;
- automatic remote closing of the electric windows;

- automatic remote opening of the electric windows.

Range

Make sure that the correct battery type is being used, and that the battery is in good condition and inserted correctly. Its service life is approximately two years: it should be replaced when the "Keycard Battery Low" message appears on the instrument panel → 40.

card operating range

This varies according to the surroundings: take care not to accidentally lock or unlock the vehicle by inadvertently pressing the buttons on the card.

Note: if an opening element (door or luggage compartment door) is open or incorrectly shut, locking is unsuccessful and a beep is emitted.

Interference

Interference by factors in the immediate vicinity (external installations or the use of equipment operating on the same frequency as the card) may disrupt its operation.



If the battery is flat, you can still lock/unlock and start your vehicle → 49 → 151.

"Remote lighting" function

Press button 4 to switch on the interior lighting, the side lights and the dipped beam headlights for approximately 20 seconds. This can be used, for example, to identify your vehicle from a distance when parked in a car park.

Note: press button 4 again to switch off the lighting.



Recommendations

Avoid leaving the card in hot, cold or humid areas.

Do not keep the card in a place where it could be bent or damaged accidentally, such as in your back pocket.

CARD

Replacement: need for an additional card

If you lose your card or require another, you can obtain one from an authorised dealer. If a card is replaced, it will be necessary to take the vehicle **and all its cards** to an approved Dealer to re-set the system. You may use up to four cards per vehicle.



Driver's responsibility when parking or stopping the vehicle

Never leave an animal, child or adult who is not self-sufficient alone in your vehicle, even for a short time.

They may pose a risk to themselves or to others by starting the engine, activating equipment such as the electric windows or locking the doors.

Also, in hot and/or sunny weather, please remember that the temperature inside the passenger compartment increases very quickly.

RISK OF DEATH OR SERIOUS INJURY.

Fitting a strap 7

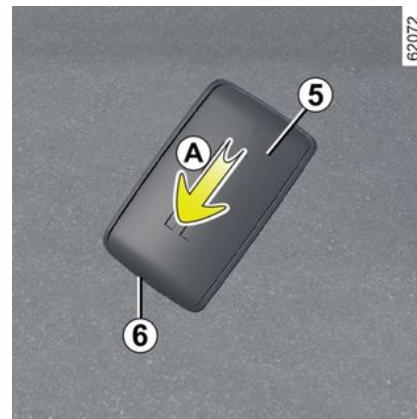

Slide the rear casing **5** downwards while pressing on area **A**.



Never insert screwdriver-type tools into the **6** opening.

CARD

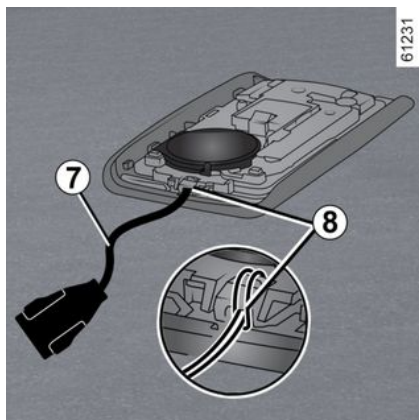

Insert the hand strap into the component **8** and pass the end of the strap through the buckle.

Position the strap at the opening **6** and close the casing.

Note: check that the diameter of the hand strap cord **7** will fit the opening **6**.

Use

There are two ways to lock/unlock the vehicle:

- in "hands-free" mode, when approaching and moving away from the vehicle;
- using the card in remote control mode.



Never leave your vehicle with the card inside.



Do not store the card anywhere it may come into contact with other electronic equipment (computer, phone etc.) as this could hinder its operation.



Driver's responsibility

Never leave an animal, child or adult who is not self-sufficient alone in

your vehicle, even for a short time.

They may pose a risk to themselves or to others by starting the engine, activating equipment such as the electric windows or locking the doors.

Also, in hot and/or sunny weather, please remember that the temperature inside the passenger compartment increases very quickly.

RISK OF DEATH OR SERIOUS INJURY.

Deactivating/activating the "hands-free" mode

Depending on the vehicle, you can deactivate/activate unlocking when approaching and locking when moving away from the vehicle.

You can also deactivate/activate the sound signal that is emitted upon locking when moving away from the vehicle → **113**.

CARD

Using the card in "hands-free" mode

2



62022

In "hands-free" mode, it is possible to lock/unlock the vehicle without using any of the buttons on the card, as long as the card is within the access zone **1**.

Note: if the vehicle has not been used for more than eight days, the "hands-free" system switches to standby. To reactivate it, press the unlocking button on the card.

"Hands-free" unlocking when approaching the vehicle

With the card in the access zone **1**, the vehicle will unlock.

Unlocking is indicated by **one flash** of the hazard warning lights and the indicator lights.

"Hands-free" locking when moving away from the vehicle

With the card on you and the doors and luggage compartment door closed, move away from the vehicle: it will be locked automatically as soon as you leave the access zone **1**.

Note: the distance at which the vehicle locks depends on the surroundings.

The indicator lights and hazard warning lights **flash twice** to indicate that the doors have locked.

The locking is confirmed by a beep.

Special features of the unlocking system

After eight days of non-use, approach unlocking is disabled.

Use the card as a remote control to unlock the vehicle and reactivate the mode.

Special features of the locking system

If a door is open or not properly closed, when you go away, the vehicle is not locked.

Special features relating to "hands-free" locking

After locking in "hands-free" mode, you have to wait approximately three seconds to be able to unlock the vehicle again. During these three seconds, the door handles can be tried to make sure that the vehicle is locked properly.

If the card has been within the detection zone **1** for approximately 15 minutes, remote locking is deactivated. To lock the vehicle, press the button **4** on the card.



62023

The vehicle cannot be locked if the card is within the zone **2**. If the vehicle is unlocked by pressing the button on the card, but the doors or luggage

CARD

compartment are not then opened, remote "hands-free" locking is disabled.



Driver's responsibility when parking or stopping the vehicle

Never leave an animal, child or adult who is not self-sufficient alone in your vehicle, even for a short time.

They may pose a risk to themselves or to others by starting the engine, activating equipment such as the electric windows or locking the doors.

Also, in hot and/or sunny weather, please remember that the temperature inside the passenger compartment increases very quickly.

RISK OF DEATH OR SERIOUS INJURY.

Using the card as a remote control

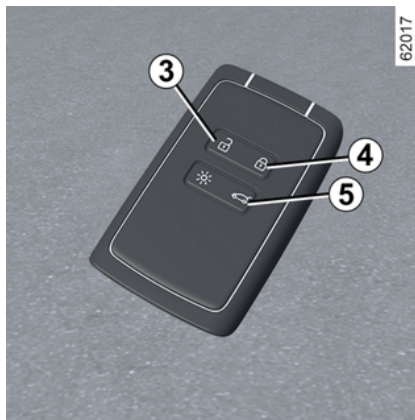

Unlocking with the card

Press the button **3**.

Unlocking is indicated by **one flash** of the hazard warning lights and the indicator lights.

If there is then an attempt trying to open a door by pressing the handle at the same time as the doors are unlocked remotely, the door concerned will remain locked. To rectify this, release the handle and unlock the vehicle again by pressing the button **3** on the card.

Locking using the card

With the doors and luggage compartment closed, press button **4**: the vehi-

cle will lock. The hazard warning lights and side indicator lights **flash twice** to indicate that the vehicle is locked.

Note: the maximum distance from which the vehicle can be locked depends on the surroundings.

Special features

The vehicle cannot be locked if one of the opening elements (door or luggage compartment) is open or not properly shut, and a beep sounds.



The card buttons are deactivated when the engine is running.



CARD

2

With the engine running, if a door is opened and closed and the card is no longer in zone **2**, the "Keycard Not Detected" message indicates that the card is not inside the vehicle. This will, for example, prevent you from driving away after dropping off a passenger who has kept the card on them.

The warning disappears when the card is detected again.

Opening/closing windows

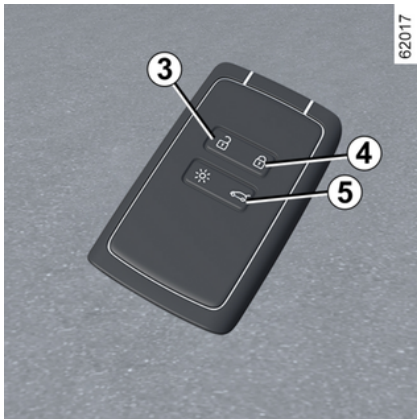

Press and hold button **3** on the card to open the 4 front and rear windows.

Press and hold button **4** on the card to close the 4 front and rear windows.

Locking/unlocking the boot only

Press button **5** to lock/unlock the luggage compartment only.



Driver's responsibility when parking or stopping the vehicle

Never leave an animal, child or adult who is not self-sufficient alone in your vehicle, even for a short time.

They may pose a risk to themselves or to others by starting the engine, activating equipment such as the electric windows or locking the doors.

Also, in hot and/or sunny weather, please remember that the temperature inside the passenger compartment increases very quickly.

RISK OF DEATH OR SERIOUS INJURY.

"Hands-free" card: battery

Operating faults

If the battery is too weak to ensure correct operation, you will still be able to start and lock/unlock the vehicle → **49**.



When they need to be replaced, be sure to use the same or equivalent type of battery (consult an Approved Dealer).



When replacing:
– make sure that the batteries are correctly inserted.

Risk of explosion.

– if the flap does not close correctly, do not use and keep out of reach of children.

CARD

Replacing the battery

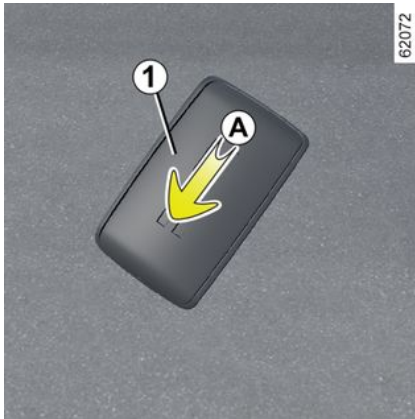

When the "Keycard Battery Low" message appears on the instrument panel, replace the card battery:

- slide the rear casing **1** downwards while pressing on area **A**;
- remove the battery cover **2**;
- remove the battery by pressing on one side and lifting the other;
- replace it according to the direction and template shown inside the cover.

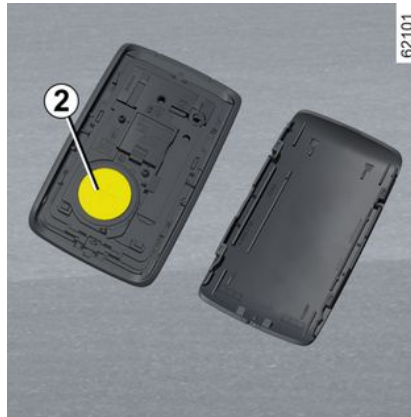

To refit, proceed in the reverse order then press one of the buttons on the card four times while you are near the vehicle: the next time the vehicle is started, the message will disappear.

Check that the cover is clipped shut.

Note: when replacing the battery, do not touch the electronic circuit or contacts on the card.



Precautions relating to batteries:

- keep batteries (new or used) out of reach of children;
- do not swallow batteries;

Risk of chemical burns which may prove fatal.

- if ingested or inserted into any part of the body, consult a doctor as soon as possible.



The batteries are available from approved Dealers, and their service life approximately two years. Check that there is no dye on the battery: risk of an incorrect electrical contact.

CARD

2



61496



Do not throw away your used batteries as rubbish. Take them to an approved Dealer or consult your local authority for information on appropriate recycling facilities.

KEY, REMOTE CONTROL

General information

Radio frequency remote control **A**



- 1** Locks all the opening elements.
- 2** Unlocking the doors and luggage compartment.
- 3** Ignition and front door key.
- 4** Unlocking the luggage compartment only.

Remote control with switchblade key **B**

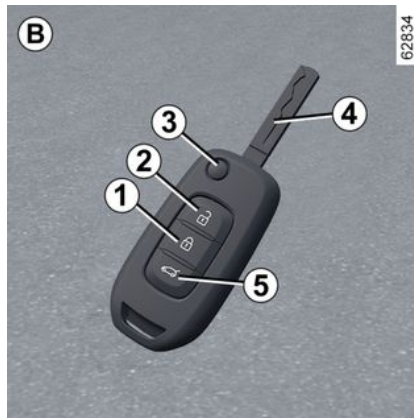

- 1** Locks all the opening elements.
- 2** Unlocking the doors and luggage compartment.
- 3** Locking/unlocking using the switchblade key. To release the insert from its housing, press the button **3** and it will come out. Press the button **3** and guide the insert back into its housing.
- 4** Ignition and front-left hand door key.
- 5** Unlocking the luggage compartment only.



The key must not be used for any function other than those described in the handbook (removing the cap from a bottle, etc.).



Driver's responsibility when parking or stopping the vehicle

Never leave an animal, child or adult who is not self-sufficient alone in your vehicle, even for a short time.

They may pose a risk to themselves or to others by starting the engine, activating equipment such as the electric windows or locking the doors.

Also, in hot and/or sunny weather, please remember that the temperature inside the passenger compartment increases very quickly.

RISK OF DEATH OR SERIOUS INJURY.

KEY, REMOTE CONTROL

The remote control unit operating range

This varies according to the environment: take care not to lock or unlock the doors accidentally by inadvertently pressing the buttons on the remote control.

Note: if a door or the luggage compartment door is open or not closed properly, the doors and luggage compartment door lock/unlock quickly.

Interference

Interference by factors in the immediate vicinity (external installations or the use of equipment operating on the same frequency as the card) may disrupt its operation.



The key must not be used for any function other than those described in the handbook (removing the cap from a bottle, etc.).



Driver's responsibility when parking or stopping the vehicle

Never leave an animal, child or adult who is not self-sufficient alone in your vehicle, even for a short time.

They may pose a risk to themselves or to others by starting the engine, activating equipment such as the electric windows or by locking the doors.

Also, in hot and/or sunny weather, please remember that the temperature inside the passenger compartment increases very quickly.

RISK OF DEATH OR SERIOUS INJURY.



Recommendations

Avoid leaving the remote control in hot, cold or humid areas.



Replacement and additional keys or remote controls

If you lose your remote control key or require another, you can obtain one from an approved dealer.

If a remote control or key is replaced, it will be necessary to take the vehicle **and all of its remote control keys** to an authorised dealer to reset them.

You may use up to four remote control keys per vehicle.

Remote control key failure

Always make sure that the correct battery type is being used, and that the battery is in good condition and inserted correctly. These batteries should have a service life of approximately two years. How to change the battery ➔ **45**.

KEY, REMOTE CONTROL

Use

Locking the doors

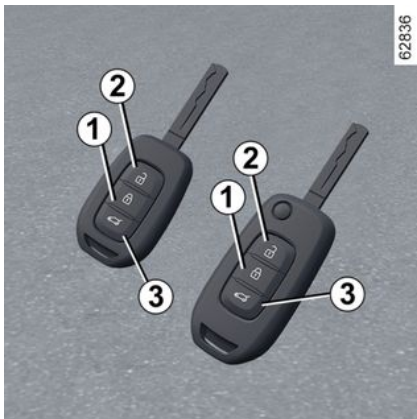

Press locking button **1**.

The hazard warning lights and side indicator lights **flash twice** to indicate that the doors have locked.

If any opening element (door or tailgate) is open or incorrectly shut, locking is unsuccessful and the hazard warning lights and side repeaters do not **flash**.

Unlocking the doors

Press unlocking button **2**.

The hazard warning lights and side indicator lights **flash once** to indicate that the doors have unlocked.

Note: if a door is not opened within approximately one minute of the door being unlocked by the remote control, the doors will lock again automatically.

Unlocking the luggage compartment only

Press and hold button **3**. The luggage compartment opens slightly and, depending on the vehicle, the luggage compartment door fully opens by itself.



The key must not be used for any function other than those described in the handbook (removing the cap from a bottle, etc.).



Driver's responsibility when parking or stopping the vehicle

Never leave an animal, child or adult who is not self-sufficient alone in your vehicle, even for a short time.

They may pose a risk to themselves or to others by starting the engine, activating equipment such as the electric windows or by locking the doors.

Also, in hot and/or sunny weather, please remember that the temperature inside the passenger compartment increases very quickly.

RISK OF DEATH OR SERIOUS INJURY.

Radio frequency remote control: batteries

Operating faults

If the battery is too weak to ensure correct operation, you will still be able to start and lock/unlock the vehicle → 49.

KEY, REMOTE CONTROL

2

 The batteries are available from approved Dealers, and their service life approximately two years. Check that there is no dye on the battery: risk of an incorrect electrical contact.

 When they need to be replaced, be sure to use the same or equivalent type of battery (consult an Approved Dealer).

Replacing the battery

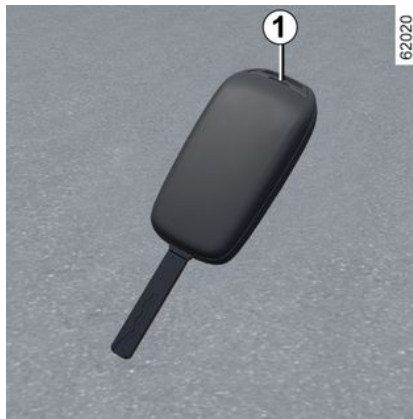

Open the case at slot **1** using a flat-blade screwdriver or similar tool and replace the battery **2** observing the type and polarity shown on the back of the cover.

Ensure that the cover is correctly clipped on and the screw tightened.

Note: it is not advisable to touch the electronic circuit in the key cover when replacing the battery.



When replacing:

- make sure that the batteries are correctly inserted.

Risk of explosion.

- if the flap does not close correctly, do not use and keep out of reach of children.

KEY, REMOTE CONTROL



Precautions relating to batteries:

- keep batteries (new or used) out of reach of children;
- do not swallow batteries;

Risk of chemical burns which may prove fatal.

- if ingested or inserted into any part of the body, consult a doctor as soon as possible.



Do not throw away your used batteries as rubbish. Take them to an approved Dealer or consult your local authority for information on appropriate recycling facilities.

61496



DOORS AND OPENING ELEMENTS

Opening and closing the doors

2

Opening from the outside



Front doors

With the doors unlocked, place your hand under the handle **1** and pull it towards you → 49.



Rear doors

With the doors unlocked, pull handle **2**.

Opening from the inside



Pull the handle **3**.

DOORS AND OPENING ELEMENTS

Child safety

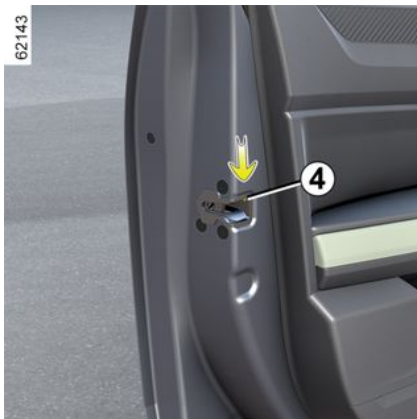

To make it impossible for the rear doors to be opened from the inside, move lever **4** on each door and check from the inside that the doors are securely locked.

Lights-on reminder audible alarm

If you have left the lights on after switching off the ignition, a warning buzzer will sound when a front door is opened (to prevent the battery from discharging, etc.).

Door or luggage compartment lid open buzzer

Depending on the vehicle, this alarm is fitted to the driver's side door or on all opening elements.

With the vehicle at a standstill, a warn-

ing light  will come on if a door or the boot is open or not properly closed.

While driving, as soon as the vehicle reaches 12 mph (20 km/h), the warn-

ing light  comes on with a beep.

Special feature

Depending on the vehicle, accessories (e.g. radio) stop working either when the engine is switched off or when the driver's door is opened or when the doors are locked.



Driver's responsibility when parking or stopping the vehicle

Never leave an animal, child or adult who is not self-sufficient alone in your vehicle, even for a short time.

They may pose a risk to themselves or to others by starting the engine, activating equipment such as the electric windows or by locking the doors.

Also, in hot and/or sunny weather, please remember that the temperature inside the passenger compartment increases very quickly.

RISK OF DEATH OR SERIOUS INJURY.

Locking/unlocking the opening elements and doors

If the remote control or, depending on the vehicle, the card does not work

In some cases, the radio frequency remote control or the card may not work:

DOORS AND OPENING ELEMENTS

- card or radio frequency remote control battery worn or run flat, vehicle battery flat etc.
- use of appliances operating on the same frequency as the card (mobile phone, etc.);
- the vehicle is located in a high electromagnetic radiation zone.

It is then possible:

- depending on the vehicle, use the radio frequency remote control or the emergency key integrated in the card to unlock the front left-hand door;
- to lock each of the doors manually;
- to use the interior door locking/unlocking control;

The card's built-in key

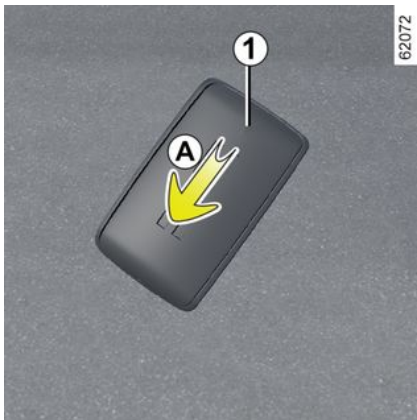

The built-in key **2** is used to lock or unlock the front left-hand door if the card is not working.

Access with key **2**

Slide the rear casing **1** downwards while pressing on area **A**.



Using the key integrated in the card

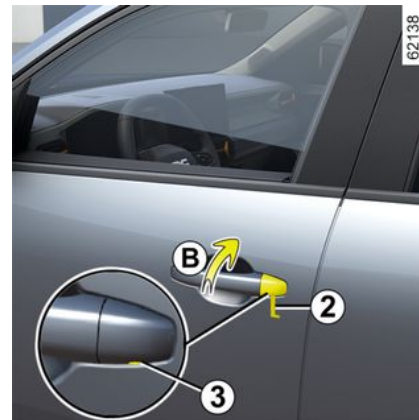

- Insert the end of the key **2** into the notch **3** at the bottom of the cover **B** on the driver's door;
- move it upwards to remove the cover **B**;
- insert the key **2** into the lock of the driver's door, then lock or unlock.

Once you are inside the vehicle, put the key back in its casing in the card.

DOORS AND OPENING ELEMENTS

Vehicles with key, remote control



Using the key

Insert the key **4** into the lock of the driver's door **5**, lock and unlock.

Interior locking/unlocking door control



Depending on the vehicle, it can be used to simultaneously lock or unlock the doors and luggage compartment. Lock or unlock the doors by pressing switch **6**.

If a door or the tailgate is open or not closed properly, the doors and tailgate lock/unlock quickly.

If transporting an object with the luggage compartment open, you can still lock the other doors: with the engine stopped, press and hold switch **6** for more than five seconds to lock the doors.

Door and tailgate status indicator

(depending on the vehicle)

With the ignition on, the warning light above switch **6** lights up and informs you of the opening element locking status:

- when the warning light is on, the doors and luggage compartment door are locked;
- indicator light off, the doors and tailgate are unlocked.

When you lock the doors, the indicator light remains lit and then goes out.



Driver's responsibility

If you decide to keep the doors locked when you are driving, remember that it may be more difficult for those assisting you to gain access to the passenger compartment in the event of an emergency.

Locking the opening elements without the card or the key

For example, in the event of a discharged battery or the card or key temporarily not working etc.

DOORS AND OPENING ELEMENTS

2

With the ignition switched off and a door or the luggage compartment door open, press and hold the switch **6** for more than five seconds.

When the door is closed, all the doors and tailgate will be locked.

Unlocking the vehicle from the outside is only possible with the card in the vehicle access zone or by using the key.



Never leave your vehicle with the key or card inside.

Automatic locking when driving

Operating principle



After the vehicle is started, the system automatically locks the doors when you reach approximately 6 mph (10 km/h).

The door can be unlocked:

- by pressing the door unlocking switch **1**;
- at a standstill, by opening a front door from inside the vehicle.

Note: if a door is opened/closed, it will automatically lock again when the vehicle reaches a speed of approximately 6 mph (10 km/h).

Activating/deactivating the function

To activate it: with the vehicle stationary and the engine on, press the switch **1** until a beep sounds.

To deactivate it: with the vehicle stationary and the engine on, press the switch **1** until a beep sounds.

Operating faults

If you notice an operating fault (automatic locking impossible), first check that all doors are correctly locked. If they are properly closed and the fault is still present, contact an approved Dealer.

Also make sure that locking has not been inadvertently deactivated.

If this is the case, reactivate it.



Driver's responsibility

If you decide to keep the doors locked when you are driving, remember that it may be more difficult for those assisting you to gain access to the passenger compartment in the event of an emergency.

DOORS AND OPENING ELEMENTS

Luggage compartment

To open



Press button **1** and lift the luggage compartment door.

To close



Lower the luggage compartment door using the interior handles **2**.



Never use the struts to close the luggage compartment door.

Electric central locking

The tailgate is locked and unlocked at the same time as the doors.

Once you have lowered the tailgate to shoulder height, release the interior handle and finish closing the tailgate by pressing down on the tailgate from the outside.



It is prohibited to attach any carrying equipment (bike rack, luggage box etc.) resting against the spoiler or tailgate. To install a carrying device on your vehicle, contact an Approved Dealer.

FRONT SEATS

Front headrests

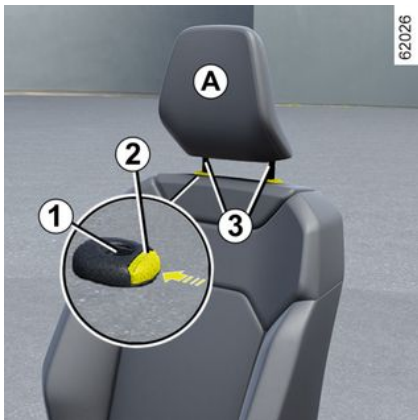

To raise the headrest

Press the **2** button and pull the headrest upwards to the height required. Check that it is correctly locked.

To lower the headrest

Press the button **2** and guide the headrest down to the desired height. Check that it is correctly locked.

To remove the headrest

Raise it to its highest position (tilt the seatback backwards if necessary). Press the button **2** and lift the headrest to release it.

To refit the headrest

Check that the headrest rods are clean **3**.

Insert the headrest rods into the holes **1** (tilt the seatback backwards if necessary). Lower the headrest until it locks and press button **2** to adjust to the desired height. Check that each rod **3** is locked on the seatback.

61287



The headrest is an important safety component: ensure that it is in place and in the correct position. The top of your head should be in line with the top of the headrest. The distance between your head and section **A** should be as short as possible.

Front seats

Settings



To move the seat forwards or back

FRONT SEATS

Lift and hold the lever **1** to unlock the seat. When the seat is in the required position, release the lever and ensure that the seat is locked in place.

To raise or lower the seat base

(depending on the vehicle)

Raise or lower the handle **2** as many times as necessary until the desired position is reached.

To tilt the seatback

Lift handle **3** and tilt the seatback to the desired position. Release the handle at the desired position and make sure that it is locked.



Lumbar adjustment

(depending on the vehicle)

Turn the handle **4** to increase or decrease the support.



After making adjustments, make sure that the seatbacks are correctly locked in place.



For safety reasons, carry out any adjustments while the vehicle is stationary.

We would advise you not to recline the seatbacks too far to ensure that the effectiveness of the seat belts is not reduced.

Make sure that the seatbacks are correctly locked in place.

Nothing should be placed on the floor (area in front of the driver) as these objects may slide under the pedals during sudden braking manoeuvres, thus obstructing their use.

Central armrest **5**

(depending on the vehicle)



To adjust the position of the armrest, slide it forwards or backwards until it reaches the stop.

2

FRONT SEATS

Heated seats



Depending on the vehicle, with the ignition on, you can activate the heated seats via the multimedia screen **6**:

- pressing the  pictogram on the required seat for the first time activates the heating system at maximum power. Three switch-integrated warning lights are illuminated;
- a second press decreases the heating to medium power. Two integrated warning lights are illuminated;
- a third press decreases the heating to minimum power. One integrated warning light is illuminated;
- a fourth press turns the heating off.

The system automatically regulates the seat temperature. The passenger seat heater is activated only if the presence of the passenger is detected and the seat belt is fastened.

REAR SEATS

Rear headrests

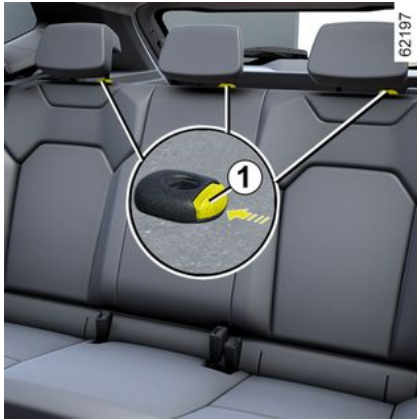

Position for use

Lift the headrest fully until it locks.
Check that it is correctly locked.

To remove the headrest

Raise the headrest as far as it will go,
then press button **1** and remove the
headrest.

To refit the headrest

Enter the rods in their housing and
push down the headrest until it locks to
use it in the high position.

Check that it is correctly locked.

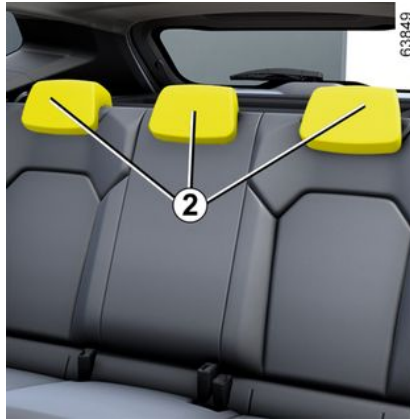

Storage position 2 for the headrest
Press button **1** and lower the headrest
completely.

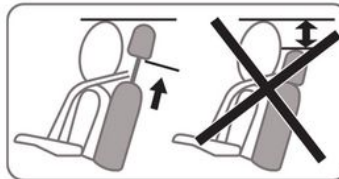

The lowest position of the headrest (position 2) is a position for storage only: do not set it in this position when the seat is occupied.



The headrest is a safety component; check that it is fitted and in the correct position.

Rear bench seat: functions

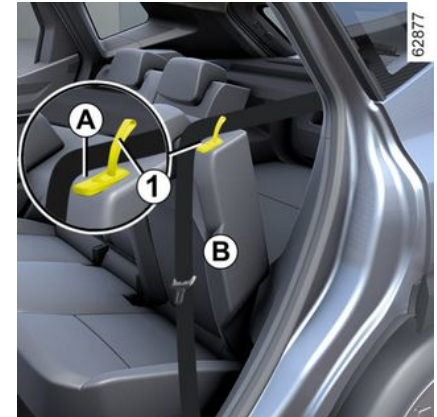

To fold down the seatback

Ensure that the front seats are far
enough forward.

Lower the headrests fully → 57.

REAR SEATS

Place the seat belts in their guides **A**. Pull the tab **1** and lower the seatback **B**.

 Before moving the seatback, put seat belt in belt guide **A** to avoid damaging it.

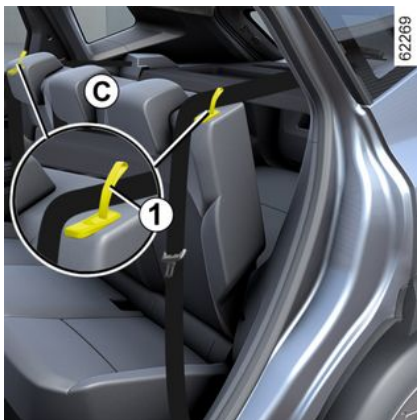

Depending on the vehicle, to unlock the bench seat **C**, simultaneously pull the tabs **1** to unlock from the inside.

To replace the seatback, proceed in the reverse order to removal.

Refit the seatback and click it back into place.



For safety reasons, carry out any adjustments while the vehicle is stationary.



When refitting the seatback, make sure it is correctly locked in place.

If seat covers are fitted, make sure these do not prevent the seatback latch from locking in.

Make sure that the seat belts are positioned correctly.
Reposition the headrests.



When moving the rear seats, ensure that nothing obstructs the anchorage points (passenger's arm or leg, a pet, gravel, cloth, toys, etc.).



Check that the rear seat belts are positioned and operating correctly each time the rear bench seat is moved.



To avoid all risk of injury, ensure that nobody is in the proximity of the moving parts.



Make sure that the seatback is correctly locked. If necessary, remove any obstacles behind the seats. Repeat the procedure until the seat is correctly locked.

SEAT BELTS

Seat belts

Always wear your seat belt when travelling in your vehicle. You must also comply with the legislation of the particular country you are in.

Before starting, adjust your driving position and then have each occupant adjust their seat belt to ensure optimum protection.

Adjusting your driving position

(depending on the vehicle)

- **Sit well back in your seat** (having removed your coat or jacket, etc.). This is essential to ensure that your back is positioned correctly;
- **adjust the distance between the seat and the pedals.** Your seat should be as far back as possible while still allowing you to fully depress the pedals. The seatback should be adjusted so that your arms are slightly bent when you hold the steering wheel;
- **adjust the position of your headrest.** For maximum safety, your head must be as close as possible to the headrest;
- **adjust the height of the seat.** This adjustment allows you to select the seat position which offers you the best possible view;

- **adjust the position of the steering wheel.**

 Make sure that the rear bench seat → 57 is locked in position correctly so that the rear seat belts will operate correctly.



Incorrectly adjusted or twisted seat belts may cause injuries in the event of an accident.

Use one seat belt per person, whether child or adult. Even pregnant women should wear a seat belt. In this case, ensure that the lap belt is not exerting too much pressure on the abdomen, but do not allow any slack.

Adjusting the seat belts



To ensure the correct adjustment and positioning of the seat belts on all seats:

- adjust the seats (seat position and seatback angle, if available);
- sit with your back firmly against the seatback;
- move the shoulder strap **1** as close as possible to the base of the neck without it actually resting against it (if necessary, adjust the height of the seat belt if possible) and make sure that the shoulder strap **1** is in contact with the shoulder;
- position the lap strap **2** so that it lies flat on the thighs and against the pelvis.

SEAT BELTS

The seat belt must be worn as close to the body as possible. e.g. avoid wearing heavy clothing, keeping bulky objects under the belts, etc.

Locking

Unwind the belt **slowly and smoothly** and ensure that the buckle **3** locks into the catch **5** (check that it is locked by pulling on the buckle **3**).

If the belt jams, allow it to return slightly before attempting to unwind it again.

If your seat belt is completely jammed, pull slowly, but firmly, so that just over 3 cm unwinds. Allow it to return slightly before attempting to unwind it again.

If there is still a problem, contact an approved dealer.

Unlocking

Press the button **4** and the seat belt will be rewound by the inertia reel. Guide the belt.



Seat belt reminder warning lights

This warning light appears on the central display **A** when the ignition is switched on and if the driver's and/or front passenger and/or rear passenger seat belt(s) (if the seat is occupied) is not fastened.





Front and rear seat belt reminder warning

With the doors closed, the graphic **6** is displayed on the instrument panel for approximately 60 seconds when the vehicle ignition is switched on. This informs the driver of the fastening status of each of the seat belts every time:

- the doors are opened during driving (vehicle speed above zero);
- a seat belt is fastened/unfastened.

Understanding the graphic **6**:

-  seat belt fastened;
-  seat occupied and seat belt unfastened;

SEAT BELTS

-  seat not occupied.

With the doors closed, the  warning light appears on the central display when the vehicle ignition is switched on if the driver's and/or passenger's seat belt(s) (if this seat is occupied) are not fastened.

When the vehicle speed is less than approximately 12 mph (20 km/h), the

 warning light appears on the central display if a seat is occupied and the seat belt is not fastened. It is accompanied by the graphic **6** which appears for approximately 60 seconds each time one of the seat belts is fastened or unfastened.

When the vehicle speed reaches or exceeds 12 mph (20 km/h), if one of the seat belts is or becomes unfastened during the journey:

- the  warning light flashes on the central display;
- and
- a beep sound for approximately 120 seconds;
- and
- the graphic **6** is displayed for approximately 180 seconds and the

 symbol appears for the seat concerned.

Always make sure that the passengers are properly fastened in and that the number of seat belts indicated as fastened corresponds to the number of seats occupied.

Note: in some cases, the warnings may be triggered if an object is placed on one of the seats.



With the doors closed, the graphic **7** is displayed on the instrument panel for approximately 60 seconds when the vehicle ignition is switched on. This informs the driver of the fastening status of each of the seat belts every time:

- the doors are opened during driving (vehicle speed above zero);
- a seat belt is fastened/unfastened.

Understanding the graphic 7:

- symbol in green: seat belt fastened;
- symbol in red: the seat is occupied and the seat belt is not fastened;
- symbol in grey: seat not occupied.

With the doors closed, the  warning light appears on the central display when the vehicle ignition is switched on if the driver's and/or passenger's seat belt(s) (if this seat is occupied) are not fastened.

When the vehicle speed is less than approximately 12 mph (20 km/h), the

 warning light appears on the central display if a seat is occupied and the seat belt is not fastened. It is accompanied by the graphic **7** which appears for approximately 60 seconds each time one of the seat belts is fastened or unfastened.

When the vehicle speed reaches or exceeds 12 mph (20 km/h), if one of the seat belts is or becomes unfastened during the journey:

- the  warning light flashes on the central display;
- and

SEAT BELTS

– a beep sound for approximately 120 seconds;

and

– the graphic 7 is displayed for approximately 180 seconds and the symbol for the seat concerned appears in red.

Always make sure that the passengers are properly fastened in and that the number of seat belts indicated as fastened corresponds to the number of seats occupied.

Note: in some cases, the warnings may be triggered if an object is placed on one of the seats.

Rear seat belts

Rear seat belts 8



The belts are fastened, unfastened and adjusted in the same way as the front belts.



 Make sure that the rear bench seat → 57 is locked in position correctly so that the rear seat belts will operate correctly.



Check that the rear seat belts are positioned and operating correctly each time the rear seats are moved.

ADDITIONAL SAFETY DEVICES

Methods of restraint in addition to the front seat belts

Depending on the vehicle, they may comprise:

- front seat belt inertia reel pretensioners;
- chest force limiters;
- airbags driver and passenger front.

These systems are designed to act independently or together when the vehicle is subjected to a frontal impact.

Depending on the severity of the impact, the system can cause:

- blocking of the seat belt;
- the seat belt pretensioner to hold the occupant in the seat, in addition to the force limiter;
- the front airbag.

Pretensioners

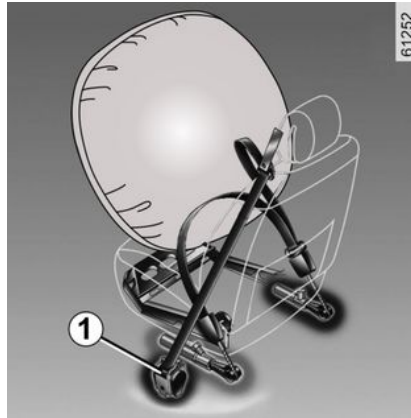

The pretensioners hold the seat belt against the body, holding the occupant more securely against the seat, thus increasing the seat belt's efficiency.

With the ignition on, following a significant frontal impact and depending on the severity of the impact, the system may trigger the seat belt inertia reel pretensioner **1** which instantly retracts the seat belt.

Load limiter

Above a certain level of impact force, this mechanism is used to limit the force of the belt against the body so that it is at an acceptable level.



- Have the entire restraint system checked following an accident.
- No operation whatsoever is permitted on any part of the system (pretensioners, airbags, computers, wiring) and the system components must not be reused on any other vehicle, even if identical.
- Only qualified personnel from our Network may work on the airbags; otherwise the system may trigger accidentally and cause injury.
- The electrical trigger system may only be tested by a specially trained technician using special equipment.
- When the vehicle is scrapped, contact an approved dealer for disposal of the pretensioner and airbags gas generators.

driver and passenger front Airbags

These are provided for the driver and the front passenger seats (location **A**). A "airbag" mark on the steering wheel, dashboard (airbag area **A**) and, de-

ADDITIONAL SAFETY DEVICES

pending on the vehicle, a label at the bottom of the windscreen provide a reminder that this equipment is present.

Each airbag system consists of:

- an airbag and gas generator fitted on the steering wheel for the driver and in the dashboard for the passenger;
- an electronic unit for monitoring the system controlling the gas generator electrical trigger;
- a single warning light  on the instrument panel;
- remote sensors (depending on the vehicle).



The airbag system uses pyrotechnic principles.

This explains why, when the airbag inflates, it will generate heat, produce smoke (this does not mean that a fire is about to start) and make a banging noise. In a situation where an airbag is required, it will inflate immediately and this may cause some minor, superficial grazing to the skin or other problems.



Operation

This system is only operational when the ignition is switched on.

In the event of a severe **frontal** impact, the airbag(s) inflate rapidly, cushioning the impact of the driver's head and chest against the steering wheel and of the front passenger against the dashboard. They then deflate immediately so that the passengers are not in any way hindered when leaving the vehicle.

Operating faults



This warning light comes on when the engine is started and then goes out after approximately three seconds.

If it does not come on when the ignition is switched on or if it stays on, there is a fault in the system.

Contact your approved Dealer as soon as possible;

Your protection will be reduced until this fault is rectified.

ADDITIONAL SAFETY DEVICES

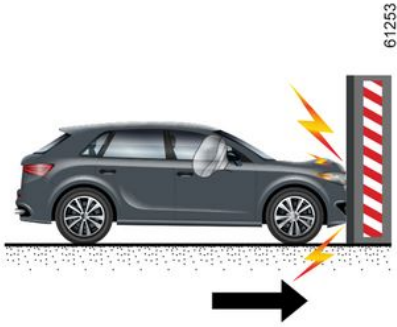

The following cases trigger the pretensioners or the airbags :

In a frontal impact against a rigid (non-deformable) surface at an impact speed equal to or greater than **16 mph (25 km/h) km/h**.

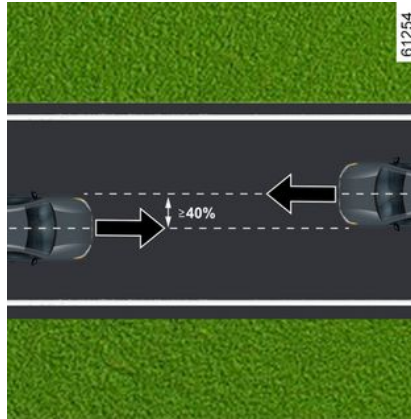

In a frontal impact with another vehicle of an equivalent or higher category, with an impact area equal to or greater than 40%, where the speed of both vehicles is equal to or greater than **25 mph (40 km/h) km/h**.

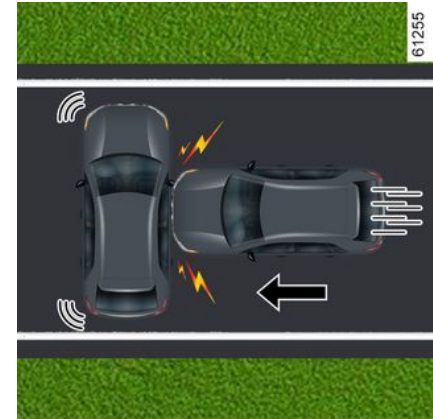

In a side impact with another vehicle of an equivalent or higher category, at an impact speed equal to or greater than **31 mph (50 km/h) km/h**.

ADDITIONAL SAFETY DEVICES

2

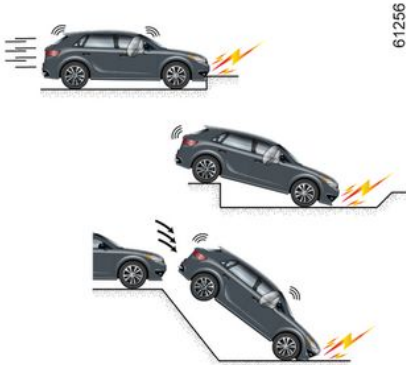

In the following examples, the pretensioners or airbags may be triggered:

- impacts to the underside of the vehicle, from kerbs;
- potholes;
- a fall or a hard landing;
- stones;
- ...



The pretensioners or airbags may not be triggered by:

- a rear impact, however severe;
- the vehicle overturning;



- side impact at the front or rear of the vehicle;
- frontal impact, underneath the tail of a lorry;
- frontal impact against an obstacle with a sharp angle;
- ...

ADDITIONAL SAFETY DEVICES

Warnings

All of the warnings below are given so that the airbags not obstructed in any way when it is inflated and also to prevent the risk of serious injuries caused by items which may be dislodged when it inflates.

2



Warnings in relation to the driver's airbag

- Do not modify the steering wheel or the boss.
- Do not cover the steering wheel boss under any circumstances.
- Do not attach any objects (badge, logo, watch, telephone cradle, etc.) to the steering wheel boss.
- The steering wheel must not be removed (except by qualified personnel from our Network).
- Do not sit too close to the steering wheel: adopt a driving position whereby your arms are slightly bent → 59. This will allow sufficient space for the airbag to deploy correctly and be fully effective.

Warnings in relation to the passenger airbag

- Do not attach or glue any objects (badge, logo, clock, telephone holder, etc.) to the dashboard on or near the airbag.
- Do not place anything between the dashboard and the passenger (animal, umbrella, walking stick, parcels, etc.).
- The passenger must not put his or her feet on the dashboard or seat as there is a risk that serious injuries may be sustained. As a general rule, keep all body parts (knees, hands, head, etc.) away from the dashboard.
- Reactivate the passenger airbag as soon as you remove the child seat to ensure the protection of the front passenger in the event of an impact.

A REAR-FACING CHILD SEAT MUST NOT BE FITTED TO THE FRONT PASSENGER SEAT UNLESS THE ADDITIONAL RESTRAINT SYSTEMS ARE NOT DEACTIVATED → 90.

ADDITIONAL SAFETY DEVICES

2

Methods of restraint in addition to the rear seat belts

Depending on the vehicle, they may comprise:

- **side seat belt inertia reel pretensioners;**
- **chest force limiters.**

These systems are designed to act independently or together when the vehicle is subjected to a frontal impact.

Depending on the severity of the impact, the system can cause:

- blocking of the seat belt;
- the seat belt inertia reel pretensioner (which engages to correct seat belt slack).

Load limiter

Above a certain severity of impact, this mechanism is used to limit the force of the belt against the body so that it is at an acceptable level.

Side seat belt pretensioners

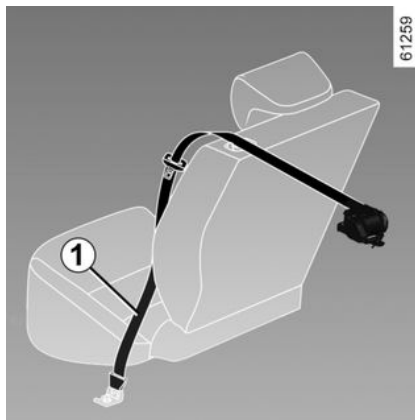

The pretensioners hold the seat belt against the body, holding the occupant more securely against the seat, thus increasing the seat belt's efficiency.

With the ignition on, following a significant frontal impact and depending on the severity of the impact, the system may trigger the seat belt inertia reel pretensioner **1** which instantly retracts the seat belt.



– Have the entire restraint system checked following an accident.

– No operation whatsoever is permitted on any part of the system (pretensioners, airbags, computers, wiring) and the system components must not be reused on any other vehicle, even if identical.

– Only qualified personnel from our Network may work on the airbags; otherwise the system may trigger accidentally and cause injury.

– The electrical trigger system may only be tested by a specially trained technician using special equipment.

– When the vehicle is scrapped, contact an approved dealer for disposal of the pretensioner and airbags gas generators.

Side protection devices

Side Airbags

(depending on the vehicle)

ADDITIONAL SAFETY DEVICES

This airbag may be fitted to each of the front seats and is activated at the sides of the seats (door side) to protect the occupants in the event of a severe side impact.

Curtain Airbags

This is an airbag fitted (depending on the vehicle) along the upper sides of the vehicle – they inflate along the front and rear door side windows to protect the passengers in the event of a severe side impact.



Depending on the vehicle, a marking on the wind-screen informs you of the presence of additional means of restraint (airbags, pretensioners etc.) in the passenger compartment.

ADDITIONAL SAFETY DEVICES

Warnings

2



Warning related to the side airbag airbag

- **Fitting seat covers:** seats equipped with an airbag require covers specifically designed for your vehicle. Contact an approved dealer to find out if such covers are available from our Network. The use of any covers other than those designed for your vehicle (including those designed for another vehicle) may affect the operation of the airbags and reduce your protection.
- In the front, do not place any accessories, objects or even pets between the seatback, the door and the internal fittings. Do not cover the seatback with objects such as clothes or accessories. This may prevent the airbag from operating correctly or cause injury when the airbag is deployed.
- No work or modification whatsoever may be carried out on the seat or internal fittings, except by qualified personnel from our Network.
- The airbag deploys through the slits in the front seatbacks (door side): never insert any objects in these slits.

ADDITIONAL SAFETY DEVICES

Additional methods of restraint

All of the warnings below are given so that the airbags not obstructed in any way when it is inflated and also to prevent the risk of serious injuries caused by items which may be dislodged when it inflates.

2



The airbag is designed to complement the action of the seat belt. Both the airbag and the seat belt are integral parts of the same protection system. It is therefore essential to wear seat belts at all times. If seat belts are not worn, the occupants are exposed to the risk of serious injury in the event of an accident. It may also increase the risk of minor superficial injuries occurring when the airbag is deployed, although such minor injuries are always possible with airbags.

If the vehicle should overturn or suffer a rear impact, however severe, the pretensioners and airbags are not always triggered. Shocks to the underbody of the vehicle, from pavements, potholes, stones etc. can all trigger these systems.

- No work or modification **whatsoever** may be carried out on any part of the driver or passenger airbag system (airbag, computer, wiring harness etc.), except by qualified network personnel.
- To ensure that the system is in good working order and to avoid accidental triggering of the system which may cause injury, only qualified Network personnel may work on the airbag system.
- As a safety precaution, have the airbag system checked if your vehicle has been involved in an accident, or is stolen or broken into.
- When selling or lending the vehicle, inform the new purchaser of these conditions when handing over this vehicle user manual.
- When scrapping your vehicle, contact your approved Dealer for disposal of the gas generator(s).

ADDITIONAL SAFETY DEVICES

Operating faults

2



The indicator light **1** lights up when the ignition is switched on and goes out after a few seconds.

If it does not light up when the ignition is switched on, or if it lights up when the engine is running, there is a fault with the system (airbags, pretensioners, etc.) for the front and/or rear seats.

Contact your approved Dealer as soon as possible; Your protection will be reduced until this fault is rectified.

CHILD SAFETY

General information

Carrying children

Please ensure that you comply with the legislation of your country.

Children, and adults, must be correctly seated and strapped in for all journeys. The children being carried in your vehicle are your responsibility.

A child is not a miniature adult. Children are at risk of specific injuries as their muscles and bones have not yet finished growing. The seat belt alone would not provide suitable protection. Use an approved child seat and ensure you use it correctly.



To prevent the doors being opened, use the "Child lock" feature → 49.



A collision at 31 mph (50 km/h) is the same as falling a distance of 10 metres. Transporting a child without a restraint is the equivalent of allowing him or her to play on a fourth-floor balcony without railings!
Never travel with a child held in your arms. In the event of an accident, you will not be able to keep hold of the child, even if you yourself are wearing a seat belt. If your vehicle has been involved in a road accident, replace the child seat and have the seat belts and ISOFIX anchorage points checked.



Driver's responsibility when parking or stopping the vehicle

Never leave an animal, child or adult who is not self-sufficient alone in your vehicle, even for a short time. They may pose a risk to themselves or to others by starting the engine, activating equipment such as the electric windows or by locking the doors. Also, in hot and/or sunny weather, please remember that the temperature inside the passenger compartment increases very quickly.
RISK OF DEATH OR SERIOUS INJURY.

Using a child seat

The level of protection offered by the child seat depends on its ability to restrain your child and on its installation. Incorrect installation compromises the protection it offers the child in the event of harsh braking or an impact.

Before purchasing a child seat, check that it complies with the regulations for the country you are in and that it can be fitted in your vehicle. Consult an ap-

CHILD SAFETY

proved Dealer to find out which seats are recommended for your vehicle.

The regulations on transporting children are specific to each country.

The use of a child seat during transport depends on the age and/or the size and/or weight of the child.

For children who do not need to be transported to a child seat, make sure that the seat belt is correctly adjusted and fastened.

In all cases, you must comply with the regulations of the particular country you are in.

Before fitting a child seat, read the manual and respect its instructions. If you experience any difficulties during installation, contact the manufacturer of the equipment. Keep the instructions with the seat.



Set a good example by always fastening your seat belt and teaching your child:

- to strap themselves in correctly;
- to always get in and out of the car at the kerb, away from busy traffic.

Do not use a second-hand child seat or one without an instruction manual.

Check that there are no objects in the vicinity of the child seat which could impede its operation.



Never leave a child unattended in the vehicle.

Check that your child is always strapped in and

that the belt or safety harness used is correctly set and adjusted.

Avoid wearing bulky clothing which could cause the belts to slacken → 59.

Never let your child put their head or arms out of the window.

Check that the child is in the correct position for the entire journey, especially if asleep.

CHILD SAFETY

Choosing a child seat



Rear-facing child seats

A baby's head is, proportionally, heavier than that of an adult and its neck is very fragile. Transport the child in this position as long as possible (until the age of 2 at the very least). It supports both the head and the neck. Choose a bucket type seat for best side protection and change it as soon as the child's head is higher than the shell.



Forward-facing child seats

Up to 18 kg or 4 years, the child may travel on a forward-facing seat. Choose a seat according to the size of the child: the head and abdomen, etc. The child's head and abdomen need to be protected as a priority. A forward-facing child seat which is firmly attached to the vehicle will reduce the risk of impact to the head. Ensure your child travels in a forward-facing seat with a harness for as long as their size permits. Choose a bucket type seat for optimum side protection.w



Booster cushions

From 15 kg or 4 years, the child can travel using a booster seat, which will enable the seat belt to be adapted to suit his size and shape. The booster seat cushion must be fitted with guides to position the seat belt on the child's thighs rather than the stomach. It is recommended that you use a seatback which can be adjusted in terms of height to position the seat belt in the centre of the shoulder. It must never rest on the neck or on the arm. Choose a bucket type seat for optimum side protection.w

CHILD SAFETY

2



List of manufacturer's recommended methods of restraint for children:



63132

Always check that the seat belt is correctly fastened by pulling it up, then pulling it out fully whilst pressing on the child seat.

Check that the seat is correctly held by moving it from side to side and back to front: the seat should remain firmly fixed.

Check that the child seat has not been installed at an angle and that it is not resting against a window.



Do not use the child seat if it risks unfastening the seat belt restraining it: the base of the seat must not rest on the buckle and/or catch of the seat belt.



The seat belt must never be twisted or the tension relieved. Never pass the shoulder strap under the arm or behind the back.

Check that the seat belt has not been damaged by sharp edges. If the seat belt does not operate normally, it will not protect the child. Consult an approved Dealer. Do not use this seat until the seat belt has been repaired.

Choosing a child seat mounting

There are two ways to attach child seats: using the seat belt or using the ISOFIX system.

Attachment via the seat belt

The seat belt must be adjusted in order to ensure it works in the event of sudden braking or impact.

Ensure that the strap paths indicated by the child seat manufacturer are observed.

Attachment using the ISOFIX system

Authorised child seats ISOFIX are approved in accordance with current regulations if any of the four cases below applies:

- Universal ISOFIX 3-point forward-facing seat;
- Semi-universal ISOFIX 2-point seat;
- vehicle-specific;
- i-Size which has either:
 - a strap which attaches to the third ring of the seat concerned;
 - or a strut that rests on the vehicle floor, compatible with the approved seat i-Size, the role of which is to prevent the child seat from moving in the event of a collision.

CHILD SAFETY

In the latter three cases check that your child seat can be installed by consulting the list of compatible vehicles.

Attach the child seat with the ISOFIX locks, if these are provided. The ISOFIX system allows quick, easy and safe fitting.

The ISOFIX system consists of 2 rings and, in some cases, a third ring.



No modifications must be made to the component parts of the originally fitted restraint system (seat belts, ISOFIX, seats and their mountings).



Before using an ISOFIX child seat that you purchased for another vehicle, check that its installation is authorised. Consult the list of vehicles which can be fitted with the seat with the equipment manufacturer.

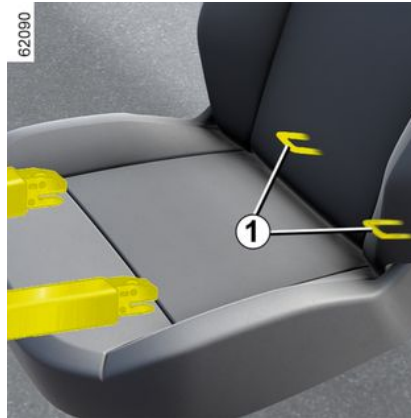

The two rings **1** are located between the seatback and the seat base and

are identified by a  mark.



The third ring of each side seat is used to attach the upper strap on some child seats.

Pass the belt between the seatback and the rear parcel shelf (to remove the parcel shelf → **300**).

2

CHILD SAFETY

2



The ISOFIX anchorage points have been exclusively designed for child seats with the ISOFIX system. Never fit a different type of child seat, seat belt or other objects to these fittings. Check that nothing is obstructing the anchorage points.

If your vehicle has been involved in a road accident, have the ISOFIX anchorage points checked and replace your child seat.

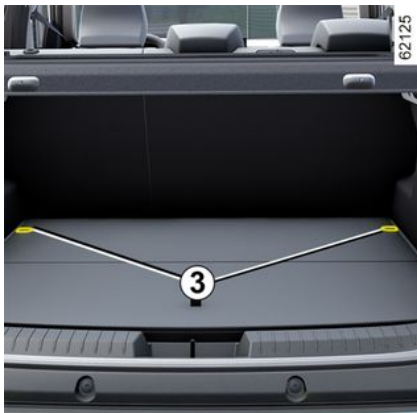

Attach the hook on the belt to one of the rings **2** (version 4x2) or **3** (version 4x4).

Pull the belt so that the back of the child seat comes into contact with the back of the vehicle seat.

Note: it is essential to use the rings

marked with the symbol .



Check that the seatback of the forward-facing child seat is in contact with the seatback of the vehicle seat. In this case, the child seat may not always rest on the seat base of the vehicle seat.



The child seat strap **must** be attached to the corresponding ring.

CHILD SEATS

Fitting a child seat, general information

Some seats are not suitable for fitting child seats. The diagram on the following page shows you how to attach a child seat.



Fit the child seat in a rear seat wherever possible.

Make sure the child seat or the child's feet do not prevent the front seat from locking correctly → 54.

Check that when installing the child seat in the vehicle it is not at risk of coming loose from its base. If you have to remove the headrest, check that it is correctly stored so that it does not come loose under harsh braking or impact.

Always attach the child seat to the vehicle even if it is not in use so that it does not come loose under harsh braking or impact.

The types of child seats indicated may not be available. Before using a differ-

ent child seat, check with the manufacturer that it can be fitted.

In the front seat

The laws concerning children travelling in the front passenger seat differ in every country. Consult the legislation in force and follow the indications on the diagram on the following page.

Before installing a child seat on this seat (if authorised and depending on the vehicle):

- lower the seat belt as far as possible;
- move the seat as far back as possible;
- gently tilt the seatback away from the vertical position (approximately 25°);
- on equipped vehicles, raise the seat base as far as possible.

Always fully raise the seat headrest so that it does not interfere with the child seat → 54.

After installing the child seat, push the front passenger seat at least one notch. In the case of a rear-facing child seat, do not let it touch the dashboard.

Do not change other settings after installing the child seat.



RISK OF DEATH OR SERIOUS INJURY: before fitting a rear facing child seat on the front passenger seat, check that the airbag has been deactivated

→ 90.

In the rear side seat

A carrycot can be installed across the vehicle and will take up at least two seats. Position the child with his or her feet nearest the door.

Before installing a child seat in the ISOFIX anchoring points on a rear side seat, check that the seat belt buckles are not placed between the two ISOFIX anchorage points in this seat. If necessary, move the buckle from the seat in question towards the centre of the vehicle.

In order to install a rear-facing child seat, move the front seat as far forward as possible, then move the front seat back as far as it will go, without allowing it to come into contact with the child seat.

For the safety of a child in the facing forwards, move the seat as far back as possible and move the seat in front of the child forward, remembering to

CHILD SEATS

move the seatback forwards to avoid contact between the seat and the child's legs.

2 In all situations, remove the headrest of the rear seat on which the child seat is positioned → 57.

If necessary, position the rear seat as far back as possible. This must be done before fitting the child seat. Check that the child seat is resting against the back of the rear seat.

In rear centre seat

A child seat may only be fitted in this seat if it is equipped with an inertia-reel seat belt.

For any additional information, please contact an authorised dealer.



Ensure that the child seat or the child's feet do not prevent the locking in place of the seat in front

→ 54 or → 57.



A child seat with floor supports must never be installed on the rear centre seat. **RISK OF**

DEATH OR SERIOUS INJURY.



Installing a booster seat (group 2 or 3)

Check that the seat belt

→ 59 operates (winds) correctly.

Adjust the seat belt by positioning:

- the shoulder strap on the child's shoulder without it touching their neck;
- the lap belt so that it lies flat on the thighs and against the pelvis.

If necessary, adjust the position of the vehicle seat.

CHILD SEATS

Attachment by seat belt

2

Installation visual for the five-door, five-seat version

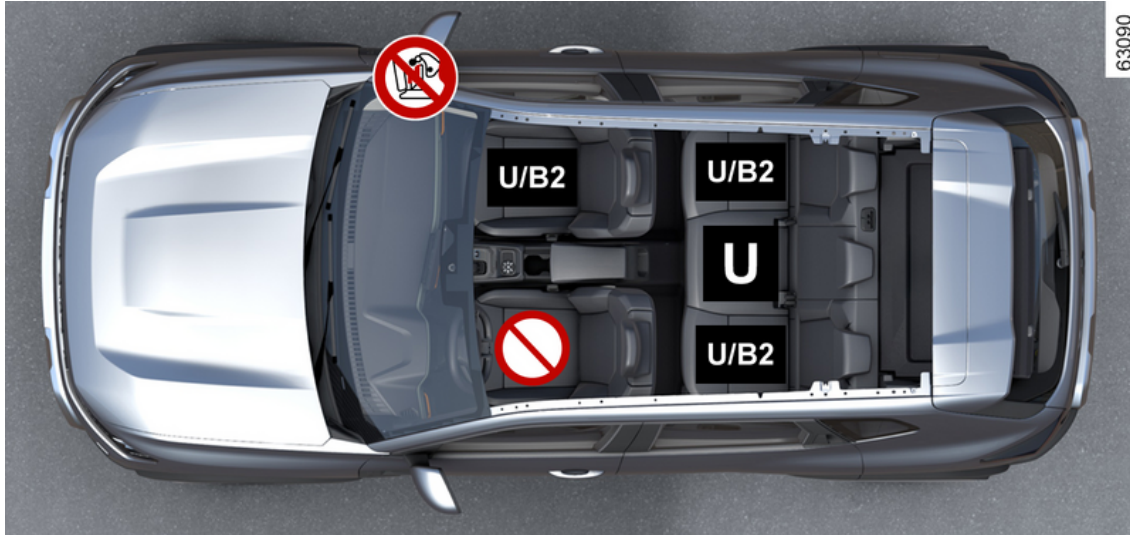

CHILD SEATS



Check the status of the airbag before fitting a child seat or allowing a passenger to use the seat.



Seat not suitable for fitting child seats.



Seat equipped for attaching a "Universal" approved seat using a seatbelt.



: seat enabling a child seat with "B2" approval to be attached by seat belt.



RISK OF DEATH OR SERIOUS INJURY: before fitting a child seat in the front passenger seat, check that the airbag has been deactivated → 90.



Check that your child is always strapped in and that the belt or safety harness used is correctly set and adjusted → 59.
If necessary, adjust the seat position accordingly.



Using a child safety system which is not approved for this vehicle will not properly protect the baby or child. They risk serious or even fatal injury.

CHILD SEATS

Installation table

Five-door, five-seat versions

Type of child seat	Weight of the child	Front passenger seat		Rear seats	
		With airbag that cannot be deactivated or with airbag activated	Without airbag or airbag deactivated	Side seats	Centre seat
Carrycot fitted across the vehicle Approved for group 0	< 10 kg	X	X	U (4)	X
Rear-facing shell seat Approved for group 0 or 0+	< 13 kg	X	U (2) (3)	U (5)	U (5) (7)
Rear-facing seat Approved for group 0+ or 1	< to 13 kg and 9 to 18 kg	X	U (2) (3)	U (5)	U (5) (7)
Forward-facing seat Approved for group 1	9 kg to 18 kg	U (1) (3)	X	U (6)	U (6) (7)
Booster seat Approved for group 2 or 3	15 kg to 25 kg and 22 kg to 36 kg	U/B2 (1) (3)	X	U/B2 (6)	U (6)

CHILD SEATS



(1) RISK OF DEATH OR SERIOUS INJURY: never install a rear-facing child seat on the front seat if the vehicle is equipped with a passenger airbag that cannot be deactivated.

(2) RISK OF DEATH OR SERIOUS INJURY: before fitting a rear-facing child seat in the front passenger seat, check that the airbag has been deactivated → 90.

Refer to the "Child safety equipment" booklet available from the network to choose the seat suited to your child and recommended for your vehicle.

X= Seat not suitable for fitting child seats.

U= Seat allowing a child seat with "Universal" approval to be attached by seat belt: check that it can be fitted.

B2= Booster seats in groups 2 and 3 (15 to 25 kg and 22 to 36 kg).

(3) Raise the seat to the maximum and position it as far back as possible, tilting the seatback slightly (approximately 25°).

(4) A carrycot can be installed across the vehicle and will take up at least two seats. Position the child with his or her feet nearest the door.

(5) In order to install a rear-facing child seat, move the front seat as far forward as possible, then move the front seat back as far as it will go without allowing it to come into contact with the child seat.

(6) Always retract the headrest of the rear seat on which the child seat is positioned. This action must be performed before fitting the child seat → 57. Move the seat in front of the child forwards, move the seatback forward to avoid contact between the seat and the child's legs.



(7) RISK OF DEATH OR SERIOUS INJURY: a child seat with a floor support must never be fitted.

CHILD SEATS

Attachment using the ISOFIX system

2

Installation visual for the five-door, five-seat version





CHILD SEATS

 Seat not suitable for fitting child seats.

Child seat attached using the mounting ISOFIX

 Seat which allows an ISOFIX child seat to be fitted.

 The rear side seats are equipped with an anchorage point allowing a forward-facing ISOFIX child seat with “Universal” approval to be attached. The anchorage points  are located in the boot and are visible.



Check that your child is always strapped in and that the belt or safety harness used is correctly set and adjusted
→ 59.
If necessary, adjust the seat position accordingly.



Using a child safety system which is not approved for this vehicle will not properly protect the baby or child. They risk serious or even fatal injury.

CHILD SEATS

Installation table

Four and five door versions

Type of child seat	Weight of the child	Size of seat [fixture]	Front passenger seat		Rear seats	
			With airbag that cannot be deactivated	Without airbag or airbag deactivated	Side seats	Centre seat
Carrycot fitted across the vehicle Approved for group 0	< 10 kg	L1 [F], L2 [G]	X	X	X	X
Rear-facing shell seat Approved for group 0 or 0+	< 13 kg	R1 [E]	X	X	IL (1)	X
Rear-facing seat Approved for group 0+ or 1	< to 13 kg and 9 to 18 kg	R2 [D], R2X [D]	X	X	IL (1)	X
		R3 [C]	X	X	X	X
Forward-facing seat Approved for group 1	9 kg to 18 kg	F3 [A], F2 [B], F2X [B1]	X	X	IUF-IL (1) (2)	X
Booster seat Approved for group 2 or 3	15 kg to 25 kg and 22 kg to 36 kg	B2	X	X	IUF-IL (1) (2)	X
		B3	X	X	X	X
Seat i-Size	Rear-facing seat		X	X	i-U(1)	X

CHILD SEATS

Type of child seat	Weight of the child	Size of seat [fixture]	Front passenger seat		Rear seats	
			With airbag that cannot be deactivated	Without airbag or airbag deactivated	Side seats	Centre seat
	Forward-facing seat		X	X	i-UF(1) (2)	X
	Booster seat		X	X	i-UF(1) (2)	X

Refer to the "Child safety equipment" booklet available from the network to choose the seat suited to your child and recommended for your vehicle.

X = Seat not suitable for fitting child seats.

IUF = Seat which allows forward facing child seats with "Universal" approval to be attached using ISOFIX attachments: check that it can be fitted.

IL = Seat which allows child seats with "Semi-universal" or "Vehicle specific" approval to be attached using ISOFIX attachments; check that it can be fitted correctly.

i-U = Suitable only for "Universal" front-facing and rear-facing i-Size restraint systems: check that it can be fitted.

i-UF Suitable for "Universal" front-facing and rear-facing i-Size restraint systems: check that it can be fitted.

(1) In order to install a rear-facing child seat, move the front seat as far forward as possible, then move the front seat back as far as it will go without allowing it to come into contact with the child seat.

(2) Always retract the headrest of the rear seat on which the child seat is positioned. This action must be performed before fitting the child seat ➔ 57. Move the seat in front of the child forwards, move the seatback forward to avoid contact between the seat and the child's legs.

The size of the ISOFIX child seat is indicated by a letter:

- F3 [A], F2 [B], F2X[B1]: for forward-facing seats in Group 1 (9 to 18 kg);
- R2 [D], R2X [D], R3 [C]: rear-facing seats or shell seats in Group 0+ (less than 13 kg) or Group 1 (9 to 18 kg);
- R1 [E] rear-facing shell seats in Group 0 (less than 10 kg) or 0+ (less than 13 kg);
- L1 [F], L2 [G]: carrycots in group 0 (less than 10 kg);
- B2, B3: booster seats in Groupe 2 and 3 (15 to 25 kg and 22 to 36 kg).

CHILD SAFETY: DEACTIVATING, ACTIVATING THE FRONT PASSENGER AIRBAG

Front passenger airbag deactivation

(depending on the vehicle)



Before installing a child seat on the front passenger seat:

- check that the child seat can be installed on this seat;
- it is essential **to deactivate** the airbag for a rear-facing child seat.

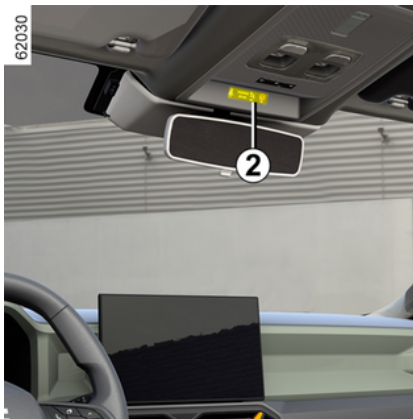

To deactivate the airbag: with the vehicle stationary and the ignition off, push and turn the lock 1 to position OFF.

When the ignition is switched on, you

must check that the  warning light is illuminated on the display 2.

This warning light remains continuously lit to let you know that you can fit a child seat.



DANGER

As the deployment of the front passenger airbag is not compatible with the positioning of a rear-facing child seat, **NEVER fit a rear-facing child restraint system on a seat protected by an ACTIVATED front AIRBAG. This can cause the CHILD'S DEATH or SERIOUS INJURY.**



the passenger airbag must be activated or deactivated only while the **vehicle is stationary**

and the **ignition is off.**

If it is interfered with when the vehicle is being driven, indicator

lights  and  will come on.

To restore the status of the airbag according to the position of the lock, switch off the ignition and then switch it back on.

CHILD SAFETY: DEACTIVATING, ACTIVATING THE FRONT PASSENGER AIRBAG



bels above) are provided to remind you of these instructions.

Front passenger airbag activation

(depending on the vehicle)



You should reactivate the airbag as soon as you remove the child seat from the front passenger seat to ensure the protection of the front passenger in the event of an impact.

To reactivate the airbag: with the vehicle stationary and the ignition off, push and turn the lock 1 to position ON.

When the ignition is switched on, it is **imperative to check** that the warning

light  is off on the display 2.

Operating faults

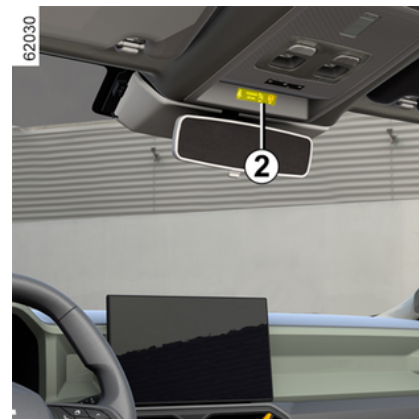

It is forbidden to fit a rear-facing child seat to the front passenger seat if the airbag activation/deactivation system is faulty.

Allowing any other passenger to sit in that seat is not recommended.

Contact your approved Dealer as soon as possible;



The markings on the dashboard and the labels **A** on each side of the passenger sun visor **3** (see example of la-

2

CHILD SAFETY: DEACTIVATING, ACTIVATING THE FRONT PASSENGER AIRBAG

2



the passenger airbag must be activated or deactivated only while the **vehicle is stationary**

and the **ignition is off**.

If it is interfered with when the vehicle is being driven, indicator

lights  and  will come on.

To restore the status of the airbag according to the position of the lock, switch off the ignition and then switch it back on.

DRIVING POSITION

Driving position: left-hand drive

2

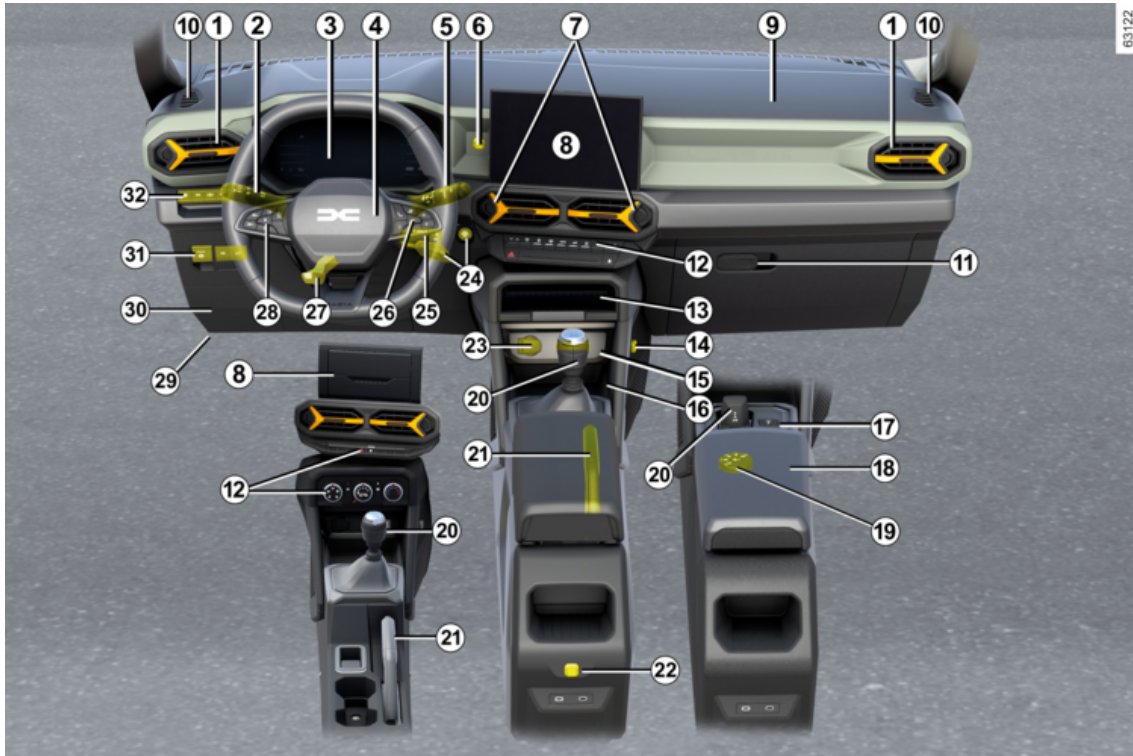

DRIVING POSITION

The fittings described **DEPEND ON THE VEHICLE VERSION AND COUNTRY.**

1. Side air vents.

2. Stalk for:

- direction indicator lights;
- exterior lights;
- rear fog lights.

3. Instrument panel.

4. Driver airbag and horn location.

5. Steering column stalk for wind-screen and rear screen wash/wiper.

6. Location for telephone holder.

7. Centre air vents.

8. Multimedia screen or, depending on the vehicle, storage.

9. Passenger airbag location.

10. Demister outlet.

11. Glovebox

12. Controls for:

- heating or air conditioning;
- front heated seats;
- hazard warning lights;
- door central locking;
- ...

13. Dashboard lower storage compartment.

14. Multi-accessory YouClipholder.

15. Sockets USB-C.

16. Charging zone/telephone storage

17. Parking position button on the automatic gearbox.

18. Centre armrest/storage compartment.

19. 4x4 (4WD) mode selector;

– activation/deactivation of the hill descent control function.

20. Gear lever (manual gearbox, depending on the vehicle).

21. Handbrake.

22. Multi-accessory YouClipholder.

23. Accessories socket.

24. Engine start/stop button or, depending on the vehicle, ignition switch.

25. Radio remote control.

26. Controls for:

- trip computer information read-out and vehicle settings customisation menu;
- remote radio and navigation system.

27. Control for adjusting steering wheel height and reach.

28. Main switch and controls for the cruise control, the speed limiter or, depending on the vehicle, the Stop and Go adaptive cruise control.

29. Bonnet release control.

30. Fixed storage compartment and fuse box.

31. Controls for:

- activating/deactivating the electronic parking brake;
- LPG control;
- ...

32. Controls for:

- My Safety activation/deactivation;
- electric headlight beam adjustment;
- ECO mode activation/deactivation;
- activation/deactivation control for the traction control;
- activation/deactivation of the function Stop and Start.

DRIVING POSITION

Driver's position, right-hand drive

2

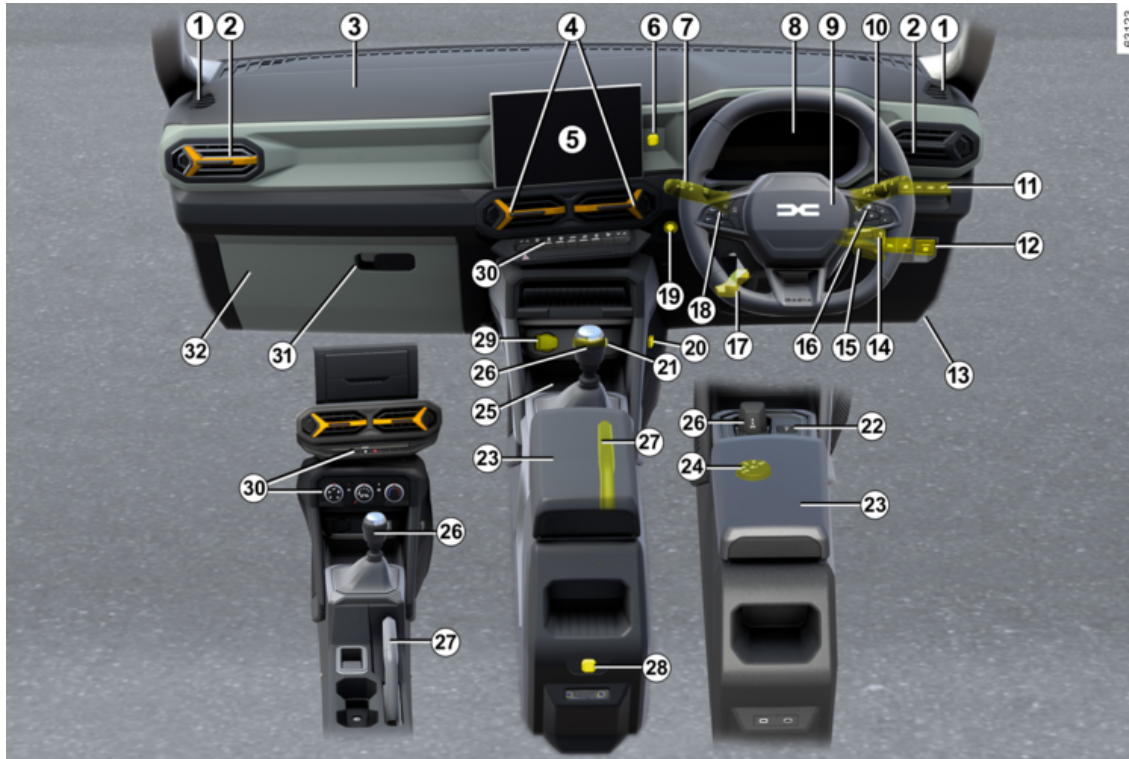

DRIVING POSITION

The fittings described **DEPEND ON THE VEHICLE VERSION AND COUNTRY.**

1. Demister outlet.
 2. Side air vents.
 3. Passenger airbag location.
 4. Centre air vents.
 5. Multimedia screen or, depending on the vehicle, storage.
 6. Location for telephone holder.
 7. Stalk for:
 - direction indicator lights;
 - exterior lights;
 - rear fog lights.
 8. Instrument panel.
 9. Driver airbag and horn location.
 10. Steering column stalk for wind-screen and rear screen wash/wiper.
 11. Controls for:
 - My Safety activation/deactivation;
 - electric headlight beam adjustment;
 - ECO mode activation/deactivation;
 - activation/deactivation control for the traction control;
 - activation/deactivation of the function Stop and Start.
 12. Controls for:
 - activating/deactivating the electronic parking brake;
- LPG control;
 - ...
13. Bonnet release control.
 14. Radio remote control.
 15. Ignition switch.
 16. Controls for:
 - trip computer information read-out and vehicle settings customisation menu;
 - remote radio and navigation system.
 17. Control for adjusting steering wheel height and reach.
 18. Main switch and controls for the cruise control, the speed limiter or, depending on the vehicle, the Stop and Go adaptive cruise control.
 19. Engine start/stop button.
 20. Multi-accessory YouClipholder.
 21. Sockets USB-C.
 22. Parking position button on the automatic gearbox.
 23. Centre armrest/storage compartment.
 24. 4x4 (4WD) mode selector;
 - activation/deactivation of the hill descent control function.
 25. Charging zone/telephone storage

26. Gear lever (manual gearbox, depending on the vehicle).

27. Handbrake.

28. Multi-accessory YouClipholder.

29. Accessories socket.

30. Controls for:

- heating or air conditioning;
- front heated seats;
- hazard warning lights;
- door central locking;
- ...

31. Glovebox

32. Fixed storage compartment and fuse box.

TRIP COMPUTER

General information

2 Trip computer A or B

Depending on the vehicle, this includes the following functions:

- mileage;
- trip settings;
- information messages;
- operating fault messages (related to

the  warning light);

- warning messages (related to the

STOP warning light);

- vehicle settings customisation menu
→ 113.



Vehicle fitted with trip computer A

Press switch **1** and select the functions by pressing switches **2** or **3**. Press switch **4** to return to the previous menu (the display depends on the vehicle equipment and country):

f) Trip log, operating fault and information message readout;

b) Trip settings:

- average consumption;
- current fuel consumption;
- estimated mileage with remaining fuel;
- mileage;
- average speed;
- average LPG consumption;
- estimated range with remaining LPG fuel;
- LPG distance;

c) total mileage and trip mileage recorder and average speed;

d) reset the tyre pressures;

e) set the time;

f) mileage before service:

- distance before service;
- mileage before oil change.

g) estimated range with remaining reagent.

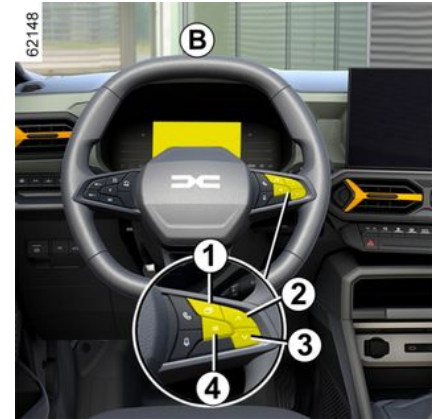

Vehicle fitted with trip computer B

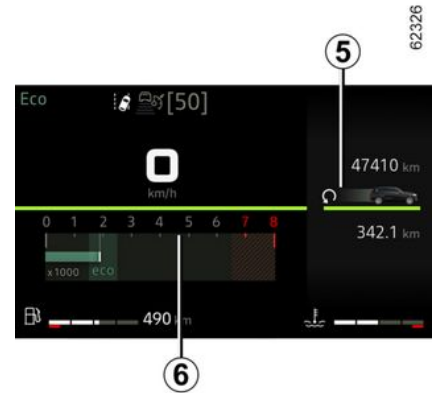

The functions are distributed in zones **5** and **6**.

TRIP COMPUTER

Press the **1** switch to browse between the zones and select the functions by repeatedly pressing the **2** or **3** switches. Press switch **4** to return to the previous menu (the display depends on the vehicle equipment and country):

- f) Trip log, operating fault and information message readout;
- b) Trip settings:
 - average consumption;
 - current fuel consumption;
 - estimated mileage with remaining fuel;
 - mileage;
 - average speed;
 - average LPG consumption;
 - estimated range with remaining LPG fuel;
 - LPG distance;
- c) trip mileage recorder and average speed;
- d) reset the tyre pressures;
- e) set the time;
- f) mileage before service:
 - distance before service;
 - mileage before oil change.
- g) estimated range with remaining reagent.

Resetting the trip mileage recorder and journey parameters (reset button)

With the display showing one of the trip settings, press and hold switch **4** "OK" until the display is reset to zero.

Interpreting some of the values displayed after resetting

The values showing average fuel consumption, range and average speed will become more stable and reliable the further you travel after pressing the reset button.

For the first few miles after pressing the reset key you will notice that the range increases as you travel.

This range takes into account the average fuel consumption since the last time the reset button was pressed.

However, average consumption can decrease when:

- the vehicle stops accelerating;
- the engine reaches its operating temperature (if the engine was cold when the reset key was pressed);
- when driving from an urban area onto the open road.

Automatic resetting of the journey parameters





Resetting occurs automatically when the maximum value of any of the parameters is exceeded.

TRIP COMPUTER





Journey settings

2

The display of information shown below **DEPENDS ON THE VEHICLE EQUIPMENT AND COUNTRY.**



Examples of selections	Interpreting the display selected
Vehicle Systems OK	a) Trip log. Successive display: <ul style="list-style-type: none">– information messages (passenger airbag OFF, etc.);– operating fault messages ("Check injection", etc.).
INSTANT CONSO  7.4 L/100	b) Journey parameters Current fuel consumption. This value is displayed after a speed of approximately 19 mph (30 km/h) is reached.
Average  5.8 L/100	Average fuel consumption since the last reset. The value is displayed after having travelled at least 400 metres since the last reset.
Range  112.4 km	Estimated range with remaining fuel. The value is displayed after driving 400 metres.
Distance  112.4 km	Distance travelled since last reset.
Average  123.4 km/h	Average speed since last reset. The value is displayed after driving 400 metres.
Average LPG	Average LPG fuel consumption.

TRIP COMPUTER

Examples of selections	Interpreting the display selected
 123.4 km/h	
Range LPG  112.4 km	Estimated range with remaining LPG fuel.
Distance LPG  112.4 km	Distance travelled using LPG since the last Reset.
Distance  112.4 km	c) Trip mileage recorder Distance travelled. since last reset.
Average  123.4 km/h	Average speed since last reset. The value is displayed after driving 400 metres.
Tyre pressure init. long press	d) Reset the tyre pressures. ➔ 183
16:30	e) Set the time. ➔ 115

TRIP COMPUTER

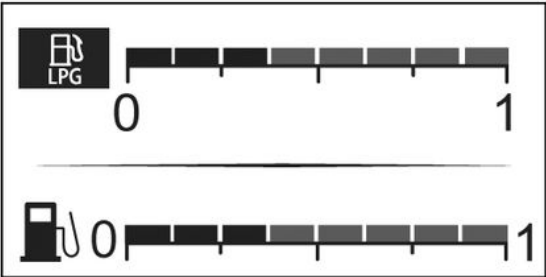
2

Examples of selections	Interpreting the display selected
 <p>The display shows two fuel gauges. The top gauge has an 'LPG' icon on the left and a scale from 0 to 1. The bottom gauge has a petrol pump icon on the left and a scale from 0 to 1. The petrol gauge is filled with a dark bar, while the LPG gauge is empty.</p>	<p>Petrol mode.</p>
 <p>The display shows two fuel gauges. The top gauge has a petrol pump icon on the left and a scale from 0 to 1. The bottom gauge has an 'LPG' icon on the left and a scale from 0 to 1. The LPG gauge is filled with a dark bar, while the petrol gauge is empty.</p>	<p>LPG mode.</p>

TRIP COMPUTER

Examples of selections On-board computer with mileage-before-service message	Interpreting the display selected
Service in 30 000 Km/12 months	<p>f) Mileage before service.</p> <p>With the ignition on and the engine not running, access the mileage before service information. When the distance or time value approaches its limit, there are several possible scenarios:</p> <ul style="list-style-type: none"> – mileage remaining less than 932 miles (1,500 km) or one month: the "Service due in" message is displayed accompanied by the nearest limit (distance or time); – if the range is 0 miles (0 km) or if the service date is reached: the "Service required" message is displayed accom-
Service due in 300 Km/24 days	
Service required	
<p>Reset: to reset the range before the next service, press and hold for approximately 10 seconds on the "OK" button until the range before service is displayed continuously.</p> <p>Note: if a service is performed without changing the engine oil, only the mileage before the next service should be reset. In the event of an oil change, both the distance before the next service and the next oil change should be reset.</p>	

TRIP COMPUTER

2

Examples of selections	Interpreting the display selected
On-board computer with mileage-before-service message	
Oil change in 30 000 km/24 months	Mileage before oil change With the ignition on and the engine not running , access the mileage information to display the mileage before the next oil change.
<p>Depending on the vehicle, the mileage before an oil change varies according to the driving style (frequent driving at low speed, door-to-door journeys, extensive use at idling speed, towing a trailer, etc.). The distance remaining until the next oil change can therefore decrease more quickly in some cases than the actual distance travelled.</p> <p>Reset: to reset the range before the next service, press and hold for approximately 10 seconds on the "OK" button until the range before oil change is displayed continuously.</p> <p>Note: if a service is performed without changing the engine oil, only the mileage before the next service should be reset. In the event of an oil change, both the distance before the next service and the next oil change should be reset.</p>	
Top Up AdBlue before 2400 km	g) Estimated range with remaining reagent.

TRIP COMPUTER

Information messages

These can help in the vehicle starting phase, or give information about a selection or a driving status.

Examples of information messages are given in the following pages.

Examples of messages	Interpreting the display selected
« Parking Brake ON »	Indicates that the parking brake has been applied.
« Vehicle Checks in Progress »	Displayed with the ignition on when the vehicle is running self-diagnostics.
« Turn Steering Wheel + START »	Turn the steering wheel slightly whilst pressing the vehicle start button to unlock the steering column.

TRIP COMPUTER

Operating fault messages

2

These appear with the  warning light and mean that you should drive very carefully to an approved dealer as soon as possible. If you fail to follow this recommendation, you risk damaging your vehicle.

They disappear when the display selection key is pressed or after several seconds and are stored in the computer log. The



warning light stays on. Examples of operating fault messages are given in the following pages.

Examples of messages	Interpreting the display selected
« Clean Diesel Filter »	Indicates the presence of water in the diesel filter; contact an approved Dealer as soon as possible.
« Check vehicle »	Indicates a fault in one of the pedal sensors, battery management system or oil level sensor.
« WARNING: Check Airbag »	Indicates a fault in the restraint system in addition to the seat belts. In the event of an accident, it is possible that they may not be triggered.
« Check Anti- Pollution System »	– Indicates a fault in the vehicle's particle filter system. – Indicates a fault in the emissions reduction system when it is accompanied by the  → 144 warning light.
« Check SOS Call »	Indicates a fault in the emergency call system.

TRIP COMPUTER

Warning messages

They appear along with the **STOP** warning light and indicate that, for your own safety, you must stop the vehicle as soon as traffic conditions allow. Stop your engine and do not restart it. Call an approved Dealer.

Some examples of warning messages are given below. **Note:** the messages appear on the display either individually or alternately (when there are several messages to be displayed), and may be accompanied by a warning light and/or a beep.

Examples of messages	Interpreting the display selected
« WARNING: Engine Failure Risk »	Indicates an injection fault, the vehicle's engine has overheated or there is a serious engine fault.
« WARNING: Power Steering »	Indicates a fault in the steering system.
« WARNING: Braking System »	Indicates a fault in the braking system. Apply the electronic parking brake manually and ensure that the vehicle is immobilised using a chock.
« Puncture »	Indicates that at least one tyre is punctured or severely underinflated.
« WARNING: Electric System »	Indicates a fault in the vehicle battery charging circuit (alternator etc.).
« WARNING: Gearbox Failure Risk »	Indicates an automatic gearbox fault.

TRIP COMPUTER

Displays and indicators

2

Instrument panel A

The presence and operation of the display and indicators **DEPENDS ON THE LEVEL OF EQUIPMENT AND THE COUNTRY.**



It lights up when the ignition is switched on.

In some cases, the appearance of a warning light is accompanied by a message.



Rev counter 1 (rpm x 1000)



Speedometers 2 and, depending on the vehicle, 3

(km or miles per hour)

Control your speed according to the speedometer 2 or 3. In case of a difference between the speedometers, refer to the approved speedometer 2 and consult an approved Dealer.

4 Fuel gauge

The number of squares lit shows the fuel level. When it is at minimum, the squares disappear and the low fuel level warning light comes on, depending on the vehicle.

Instrument panel B

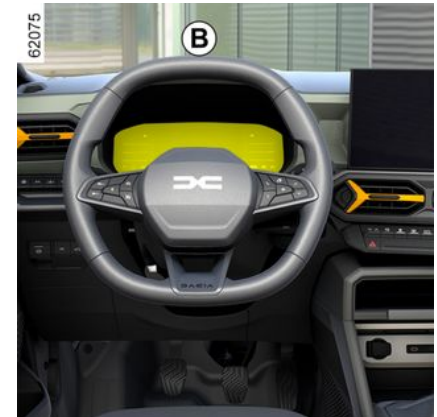

It lights up when the ignition is switched on.

TRIP COMPUTER

In some cases, the appearance of a warning light is accompanied by a message.

Depending on the vehicle, you can customise your instrument panel with the content and colours of your choice.

For vehicles fitted with a multimedia screen, refer to the equipment instructions.

For vehicles not fitted with a multimedia screen → 113.

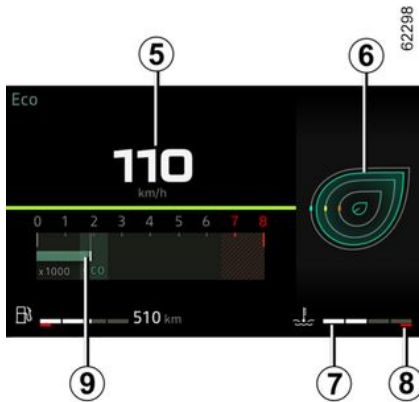

Excessive speed audible alarm

Depending on the vehicle and country,

the  warning light is displayed and a beep sounds. This beep sounds as soon as the vehicle is travelling at over 75 mph (120 km/h). This warning

light remains lit for as long as the vehicle is travelling at over 75 mph (120 km/h).

Speedometer 5

Depending on the style selected, the display varies.

Driving style indicator 6 → 177.

Coolant temperature indicator 7

In normal use, indicator 7 should be located before zone 8.

Under "intensive" operating conditions, the needle may approach this zone.

This is not serious unless the warning

light **STOP** comes on accompanied by a message on the instrument panel and a beep.

Rev counter 9

(scale x 1,000)

This is displayed differently according to how the instrument panel is customised. Depending on the style selected, it may not be displayed.

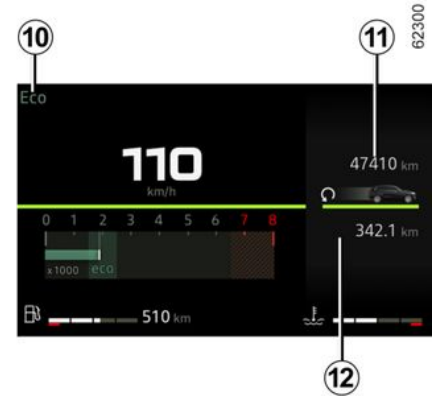

Driving mode selected 10

Total mileage recorder 11 → 100

Trip computer zone 12 → 98



TRIP COMPUTER

Multimedia information 13

Depending on the vehicle, you can display information from the multimedia screen (the compass, telephone, navigation, etc.).

Please refer to the multimedia instructions for further information.

Estimated range with remaining fuel 14

The value is displayed after driving 400 metres → 100.

Fuel gauge 15

If the level is at the minimum, the  warning light integrated into the indicator appears in orange, accompanied by a beep.

Fill the tank with at least 1.76 gal (8 litres) of fuel.

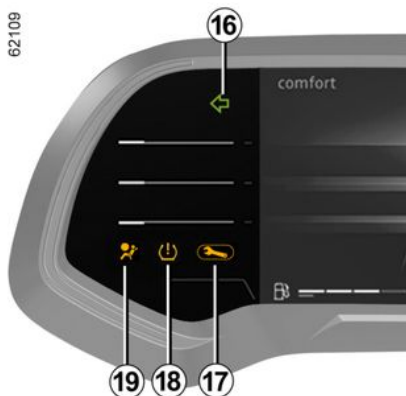

Direction change indicators 16

Warning light 17 → 116

Tyre low pressure warning light 18 → 183

Airbag warning light 19 → 63

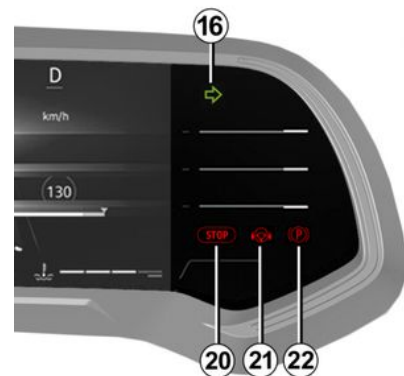

Urgent stop warning light 20 → 116

Hands off steering wheel detection warning light 21 → 201

Parking brake or Electronic parking brake warning light 22 → 169

Hybrid version

It lights up when the ignition is switched on.

In some cases, the appearance of a warning light is accompanied by a message.

TRIP COMPUTER

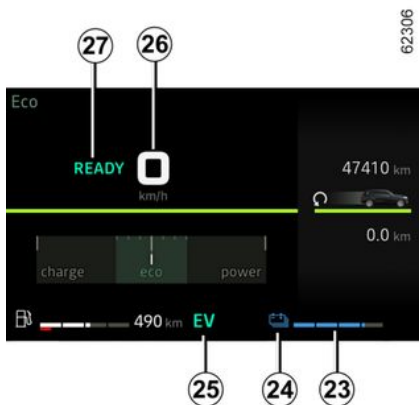

"230 V" traction battery level remaining 23

Traction battery level low

In the event of extreme use at low speed, the traction battery charge level may reach a low level.

The warning light **24** is displayed in yellow to warn you.

The electric motor performance will be limited to ensure that the Hybrid system operates correctly, until the battery charge level becomes sufficient.

Opt for a smoother driving style or, if possible, stop the vehicle without switching off the ignition until the warning light **24** appears in blue once again.

Immobilisation threshold imminent

In the event of extreme and prolonged use of the vehicle (e.g. towing or driving in steep off-road conditions) at speeds below 6 mph (10 km/h), the charge level may reach the threshold for imminent immobilisation.

A beep sounds and the warning light



If the charge level continues to drop, the electric range value will no longer be displayed.

If possible, stop the vehicle when traffic conditions allow it.

Leave the combustion engine on until the warning lights disappear.

This must be done to recharge the traction battery.

Electric operating mode warning light 25

It is displayed when only the traction battery is powering movement of the vehicle.

Message indicating vehicle ready for driving 26

The READY message appears when the ignition is switched-on and disappears when the vehicle speed exceeds 3 mph (5 km/h).

Speedometer 27

Depending on the style selected, the display varies.

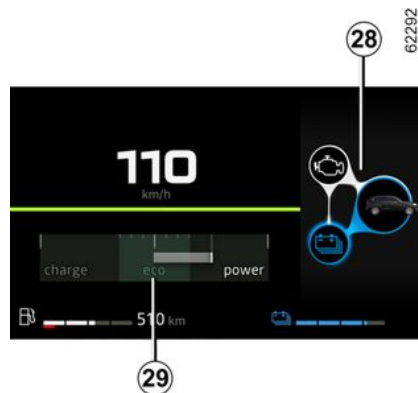

Energy flow indicator 28 → 24

Charge meter 29 → 177

Driving mode selected 30

Trip computer zone or Multimedia information zone 31

Estimated range with remaining fuel 32

The value is displayed after driving 400 metres → 100.

TRIP COMPUTER

2

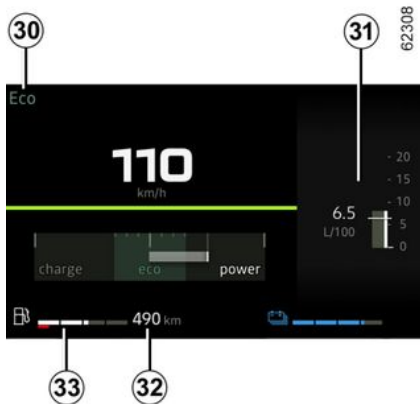

Fuel gauge 33

If the level is at the minimum, warning

light  integrated in the indicator comes on orange, accompanied by a beep.

Whatever the remaining battery level, fill the tank with at least 1.76 gal (8 litres) of fuel.

If the vehicle runs completely out of fuel, fill the tank with at least 1.76 gal (8 litres) of fuel.

Otherwise, Hybrid mode will remain unavailable.

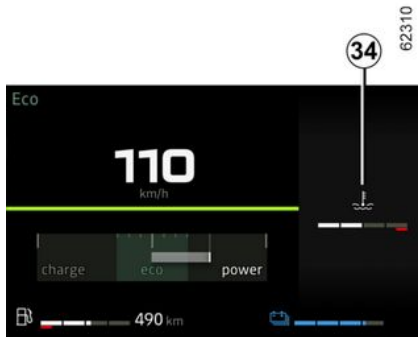

Combustion engine temperature display 34

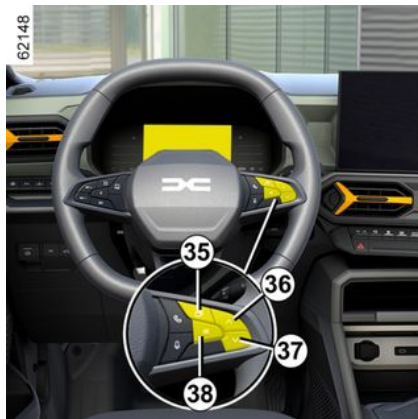

Press the switch **35** to access "VEHICLE" mode, then press switch **36** or **37** repeatedly until you reach the display **34**.

Engine oil level low warning

When the engine is started, the instrument panel display alerts you when the minimum oil level is reached → **308**.

The first time the warning appears, it can be cleared by pressing switch **38** "OK".

Subsequent warnings will disappear automatically after around 30 seconds.

Instrument panel in miles

(option to switch to km/h)

Vehicles not fitted with a multimedia screen

- With the ignition off, press the switch **35** as many times as required to reach the "SETTINGS" world;
- repeatedly press control **36** or **37** to reach "Vehicle setting", then press **38** "OK";
- repeatedly press control **36** or **37** to reach "DASHBOARD", then press **38** "OK";
- repeatedly press control **36** or **37** to reach "Unit: km/h" (or "Unit: mph"), then press **38** "OK";

Vehicles fitted with a multimedia screen.

TRIP COMPUTER

Please refer to the multimedia instructions to select the unit.

Note: in both cases, once the battery is switched off, the on-board computer automatically returns to the original unit of measurement.

To return to the previous mode, repeat the same operation.

Please refer to the multimedia instructions for further information.

Vehicle settings personalisation menu

Depending on the vehicle equipment, this function allows you to activate/deactivate and adjust some of the vehicle's functions.

Vehicles fitted with a multimedia screen 1



Accessing the settings menu

Refer to the various multimedia instructions for information on accessing the settings.

Adjusting the settings

Select a menu then the function to be modified (the display depends on the vehicle equipment and country):

- a) "DRIVING ASSIST":
 - Indicator volume.
- b) "ACCESS":
 - Release driver's door;
 - Lock doors during driving;
 - Opening/closing in hands-free mode;
 - Remote locking/approach unlocking;

- Remote locking sound;
 - Silent mode;
 - Automatic locking;
- c) "WIPING and LIGHTING":
- Follow-me-home lighting;
 - Wiping in reverse;
 - Automatic front wiping;
 - Wipe after wash;
- d) "Welcome":

- Exterior welcome;
- Automatic deployment of door mirrors;
- Interior welcome;
- Courtesy light auto mode

Depending on the function, select:

- "ON" or "OFF" to activate or deactivate it,

or

- a setting for the time the lights are switched on (e.g. for the "Follow-me-home lighting" function).

Please refer to the multimedia instructions for further information.



For safety reasons, carry out any adjustments while the vehicle is stationary.

TRIP COMPUTER

Vehicles not fitted with a multimedia screen

2



Accessing the settings menu on display 2

(depending on the vehicle)

– **With the vehicle stationary**, press the switch **3** as many times as re-

quired to reach the  tab;
or

– depending on the vehicle, press switch **3** and repeatedly press control

4 or **5** to reach the  tab;

– press switch **6 "OK"**;

– repeatedly press control **4** or **5** to

reach the  menu, then press the **6 "OK"** switch.

Adjusting the settings

Navigate using control **4** or **5** to select the function to be modified and press control **6 "OK"** to confirm (display may vary according to vehicle equipment and country):

a) "DASHBOARD":

- Language;
- Unit;

b) "VEHICLE":

- Rear windscreen wiping in reverse gear;
- Automatic windscreen wiping;
- Front-rear drip wiping function;
- Exterior welcome;

c) "PARKING ASSIST":

– Beep volume;

d) "DRIVING ASSIST":

- Lane departure warning sound volume;
- Lane departure warning sensitivity;
- Lane departure warning vibration;
- Lane Keep Assist sensitivity;
- Blind spot;
- Active braking;
- Speed warning;
- Distance warning;
- ...

e) "LIGHTING":

- Courtesy light auto mode;
- Automatic follow-me-home lighting;
- Follow-me-home lighting: XX seconds.

f) "ACCESS":

- Lock doors during driving;
- Opening/Closing in hands-free mode;
- Unlock the driver's door only;
- Automatic re-locking;
- Silent locking;
- Automatic opening/closing;
- Automatic Deployment of Door Mirrors;

g) "RESET".



function activated



function deactivated

Once a line has been selected, press the switch **6 "OK"** to modify the function.

If you select either "PARKING ASSIST" then "VOLUME" or "DASHBOARD" then "LANGUAGE", you will have to make a further selection (Park Assist sound volume or instrument panel language). In this case, make your selection and confirm it by pressing the switch **6 "OK"**, the selected value is

shown by a  in front of the line.

TRIP COMPUTER

To exit the menu, press **4** or **5** to access "BACK" and confirm by pressing **6 "OK"**. It may be necessary to carry out this operation more than once.



The vehicle settings personalisation menu cannot be used when driving. At a speed exceeding 12 mph (20 km/h), the instrument panel display switches automatically back to trip computer and warning system mode.

Clock and outdoor temperature



Vehicles fitted with a multimedia screen.

The time and outdoor temperature are displayed on the multimedia screen **1**.

Refer to the multimedia instructions.



Vehicles not fitted with a multimedia screen

Press switch **2** as many times as required to reach the "VEHICLE" tab.

Repeatedly press control **3** or **4** to set the clock.

Press and hold switch **5 "OK"** until the time display flashes.

Set the hour using the **3** or **4** control, then wait for three seconds: the minutes will flash.

Set the minutes using the **3** or **4** control, then wait for three seconds: the flashing stops and the time setting is complete.

Exterior temperature indicator

Special feature:

When the exterior temperature is between $-3\text{ }^{\circ}\text{C}$ and $+3\text{ }^{\circ}\text{C}$, the digits $^{\circ}\text{C}$ flash (to signal a risk of ice on the road).



Exterior temperature indicator

As ice formation is related to climatic exposure, local air humidity and temperature, the external temperature alone is not sufficient to detect ice.



If the power supply is cut (battery disconnected, supply wire cut, etc.), the clock must be reset.

We recommend that you do not adjust these settings while driving.

WARNING LIGHTS

The presence and operation of the warning lights **DEPEND ON THE EQUIPMENT AND COUNTRY.**

On the instrument panel **A** or **B**



If no lights or sounds are apparent, this indicates a fault in the instrument panel. This indicates that it is essential to stop immediately (as soon as traffic conditions allow). Ensure that the vehicle is correctly immobilised and contact an approved Dealer.



Warning light  means you should drive **very carefully to an authorised dealer as soon as possible.** If you fail to follow this recommendation, you risk damaging your vehicle.



For your own safety, the **STOP** warning light requires you to stop immediately, as soon as traffic conditions allow. Switch off the engine and do not restart it. Call an approved dealer.



Side light tell-tale light



Dipped beam headlight tell-tale light



Main beam headlight tell-tale light





Automatic main beam headlight warning light → 126

WARNING LIGHTS

 Front fog light tell-tale

 Rear fog lights tell-tale

 Left-hand direction indicator tell-tale light

 Right-hand direction indicator tell-tale light

 Headlight adjustment warning light

 Door(s) open warning light → 48

 Parking brake applied and electronic parking brake applied warning light → 169

 Engine standby warning light → 155.

 Engine standby unavailable warning light → 155

 LPG indicator light → 32

 Low fuel level warning light

It lights up orange when the ignition or the engine is switched on then, depending on the vehicle, goes off after a

few seconds or is displayed in white. If it appears in orange during driving and a beep sounds, fill the tank with at least 1.76 gal (8 litres) of fuel. There is only approximately 31 miles (50 km) worth of fuel left.

 LPG low fuel level warning light → 32

 Tell-tale light for Airbag

This comes on when the ignition is switched on and goes out after a few seconds. If it does not light up when the ignition is switched on, if it lights up when the engine is on, or if it flashes, this indicates that there is a fault in the system.

Contact your approved Dealer straight away.

 Oil pressure warning light

It lights up when the ignition or the engine is switched on and goes off after a few seconds.

If it comes on on the road, accompa-

nied by the **STOP** warning light and a beep, stop immediately and cut the ignition.

Check the oil level → 308.

If the level is correct, the light has come on for another reason: contact an approved Dealer without delay.

 Coolant temperature warning light

This lights up blue when you switch on the ignition or start the engine.

If it turns red, stop and let the engine idle for a minute or two.

The temperature should drop and the warning light should switch off or turn blue again. Otherwise, stop the engine. Let the engine cool down before checking the coolant.

Call an approved dealer.

 Electrotechnical system warning light

It lights up along with the **STOP** warning light and a beep sounds when the electrical assembly temperature is too high. Stop the vehicle and switch off the ignition. Consult an approved Dealer.

If it lights up accompanied by the

STOP warning light, a beep and the "EVACUATE IN SAFETY" message, switch off the ignition and do not restart the vehicle. Leave the vehicle and consult an approved dealer.

WARNING LIGHTS

2



The "EVACUATE IN SAFETY" message accompanied by the

STOP warning light and a beep indicates that for your safety you must stop the vehicle immediately, depending on the traffic conditions. Switch off the ignition. Leave it switched off. Exit the vehicle, get all passengers out of the vehicle and keep them away from the vehicle and traffic. **Fire hazards.**



If the vehicle is parked on the hard shoulder, you must warn other road users of your vehicle's presence with a warning triangle or with other devices as per the legislation applying to the country you are in.



Electrotechnical system fault warning light

When it comes on, this indicates an electrotechnical fault related to the electrical assembly (traction battery and electric motor).
Contact your approved Dealer straight away.



Electric motor fault warning light

When it comes on, this indicates a fault with the electrotechnical system linked to the electric motor. Contact your approved Dealer straight away.



Traction battery gauge warning light

This appears in yellow when the traction battery charge level has reached the reserve level → 108.



Traction battery fault warning light

If it appears, accompanied by the



warning light, this indicates a fault related to the operation of the traction battery. Contact your approved Dealer straight away.



12 V battery charge warning light

It lights up when the ignition or the engine is switched on and goes off after a few seconds.

If it comes on on the road, accompanied by the

STOP warning light and a beep, this indicates an overload or discharge in the electrical circuit.

Stop as soon as traffic conditions allow and consult an approved Dealer.



Electric operating mode warning light

It is displayed when only the electric motor and traction battery are powering the movement of the vehicle → 24.



Mode warning light ECO

This comes on when ECO mode is activated → 177.



Anti-lock braking warning light

This lights up when the ignition is switched on and goes out after a few seconds.

If it does not go out after the ignition is switched on, or lights up when driving, there is a fault with the ABS. Braking will then be as normal, without the ABS. Contact your approved Dealer straight away.

WARNING LIGHTS



Warning light for the electronic stability control (ESC) and traction control system

This lights up when the ignition is switched on and goes out after a few seconds.

The → 195 warning light may appear for several reasons.



Warning light ESC OFF → 195



Tyre under-inflation warning light

This lights up when the ignition is switched on or when the engine starts, then disappears after a few seconds → 183.



Gear change indicator

This lights up to advise you to change to a higher gear (up arrow) or lower gear (down arrow).



Power steering indicator light

It lights up when the ignition or the engine is switched on and goes off after a few seconds.

Depending on the vehicle, it lights up in the event of a battery fault → 122.

If it comes on while driving, alongside the warning light **STOP**, this means there is a system fault.

Call an approved dealer.



Brake circuit fault warning light

It lights up when the ignition or the engine is switched on and goes off after a few seconds.

If it comes on during braking and is ac-

companied by the **STOP** warning light and a beep, it indicates that the fluid level in the circuit is low or that there is a braking system fault. Stop as soon as traffic conditions allow and consult an approved Dealer.



Brake pedal warning light

This lights up when the brake pedal should be pressed → 159.



Toxic fume filter system warning light

On vehicles that are equipped, this light comes on when the engine is started and, depending on the vehicle, when the ignition is switched off while the engine is in the standby phase → 155, before going out.

- If it lights up continuously, contact an approved Dealer as soon as possible;
- If it flashes, reduce the engine speed until the light stops flashing. Contact an approved dealer as soon as possible → 176.



Preheating warning light (Diesel version)

This should come on when the ignition is switched on. It indicates that the heater plugs are in operation.

It goes out when preheating is complete. The engine can be started.



Hill descent control indicator light → 195.



Warning light to indicate a fault or unavailability of "Active emergency braking" function → 218



Warning light of the "Active emergency braking" function → 218



Lane departure prevention system warning light → 201



Hands-off steering wheel warning light → 201

WARNING LIGHTS



Overspeed warning light

A beep will sound and the warning light will come on if the vehicle exceeds 75 mph (120 km/h).



Speed limiter warning light

→ 234



Cruise control warning lights

→ 237



Adaptive cruise control warning light Stop and Go → 240



"Driver vigilance warning" function fault warning light → 226



Warning light for reagent level and faults in the exhaust gas reduction system → 144



Particle filter system warning light → 165, → 167.



4WD LOCK 4-wheel drive mode indicator light → 189



2WD 2-wheel drive mode indicator light → 189



Urgent stop warning light (red)

This lights up when the ignition is switched on and goes out as soon as the engine is started. It lights up at the same time as other warning lights, and is accompanied by a beep.

For your own safety, it requires you to stop immediately, as soon as traffic conditions allow. Switch off the engine and do not restart it.

Call an approved dealer.



Warning light (orange)

This lights up when the ignition is switched on and goes out as soon as the engine is started. It may come on in conjunction with other warning lights on the instrument panel.

It means you should **drive very carefully** to an approved Dealer as soon as possible. If you fail to follow this recommendation, you risk damaging your vehicle.



If no lights or sounds are apparent, this indicates a fault in the instrument panel. This indicates that it is essential to stop immediately (as soon as traffic conditions allow). Ensure that the vehicle is correctly immobilised and contact an approved Dealer.



On display C



Airbag passenger ON → 90



Airbag passenger OFF → 90

WARNING LIGHTS



Seat belt reminder warning
light → 59

STEERING

Steering wheel

Adjusting the steering wheel



Depending on the vehicle, the steering wheel height and depth are adjustable.

Push the lever **1** downwards and set the steering wheel to the desired position, then raise the lever to lock the steering wheel.

Make sure that the steering wheel is correctly locked.



For safety reasons, only adjust the steering wheel when the vehicle is stationary.

Steering wheel heating

(depending on the vehicle)



This function heats the steering wheel **2**.

Operating principle

When the temperature is reached, the function regulates the temperature of the heated areas for approximately 30 minutes and then switches off automatically.

Activating the function

Depending on the vehicle, with the ignition on, you can activate the heated steering wheel via the multimedia screen **3**:

Deactivating the function

- Automatically:

The function switches off automatically after the regulation phase of approximately 30 minutes.

- Manually:

Depending on the vehicle, with the ignition on, you can deactivate the heated steering wheel via the multimedia screen **3**:

Power-assisted steering

Never drive with an inadequately charged 12V battery.

Special case

Depending on the vehicle, in the event of a battery fault (disconnected, discharged battery, etc.), a reset of the power-assisted steering must be carried out. To do this:

- the vehicle stationary and on flat ground;
- with the driver alone in the vehicle,

start the engine: the  warning light and/or, depending on the vehicle,

STEERING

the "Turn steer.wheel max right-left" message are/is displayed on the instrument panel;
– turn the steering wheel fully to the left, then to the right. When the engine next starts, the indicator and/or, depending on vehicle, the message will switch off.



Never leave the steering wheel on full lock when the vehicle is stationary.



With the engine switched off, or if there is a system fault, it is still possible to turn the steering wheel. The force required will be greater.

Special feature of the Stop and Start

With the engine on standby, power-assisted steering is no longer operational. It returns to its original state when the engine is restarted or as soon as the speed is above 0.62 mph (1 km/h) (hill, slope, etc.).



Never switch off the ignition when travelling downhill, and avoid doing so in normal driving (power steering and brake servo will not function).

REAR VIEW MIRRORS

Exterior rear view mirrors

2



Adjustment

When you select the door mirror using the switch **2**, the warning light built into the switch will appear. Then use the button **1** to adjust it to the desired position.

Heated rear view mirrors

The de-icing is carried out in conjunction with the rear screen de-icing → 273 → 277.

Electrical folding mirrors

The door mirrors will fold-out automatically when the vehicle is unlocked. The door mirrors fold in when the vehicle is locked.

Note: you can deactivate/activate the door mirror folding mechanism → 113. You can force folding by pressing the switch **3**. In this situation, the door mirrors will remain folded until the **3** button is pressed again, regardless of automatic folding.

Special case

When the rear view mirror has been manually deployed or folded back, it is possible to reset it to a usage position.

To do this, press the switch **3**. A mechanical noise from the rear view mirror unit will be heard.

If a tapping noise cannot be heard, press the switch **3** again until the tapping noise can be heard from the door mirror.



For safety reasons, carry out any adjustments while the vehicle is stationary.



Objects observed in the rear view mirror glass are actually closer than they appear. For your safety, take this into account in order to correctly assess the distance before any manoeuvre.

Interior rear view mirror

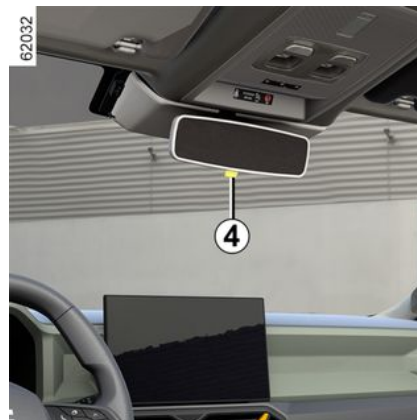

Its position can be adjusted.

When driving at night, to avoid being dazzled by the headlights of the vehicle behind, shift the small lever **4** located behind the rear view mirror.

REAR VIEW MIRRORS



For safety reasons, carry out any adjustments while the vehicle is stationary.



Objects observed in the rear view mirror glass are actually closer than they appear. For your safety, take this into account in order to correctly assess the distance before any manoeuvre.

LIGHTING AND SIGNALS

Exterior lighting and signals

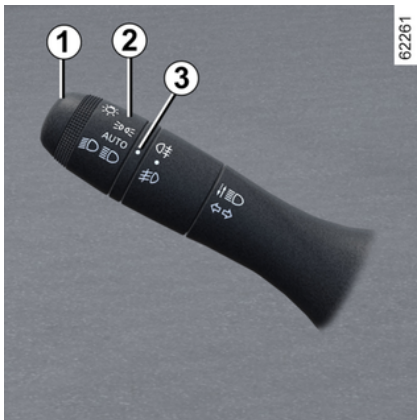

Side lights

 Turn the ring **2** until the symbol is opposite the mark **3**.

This indicator light on the instrument panel comes on.

Note: depending on the vehicle, the side lights can only be activated manually when the parking brake is applied or, depending on the vehicle, when the gear lever is in the **P** position.

Otherwise, the "Unavailable position lights" message is displayed on the in-

strument panel to inform you that it is not possible to activate the side lights.

Daytime running lights function



(front lights only)

If fitted on the vehicle, the daytime running lights come on automatically with no action on stalk **1** when the engine is started, and they go off once the engine is switched off.

Special feature:

The daytime running light will go out automatically when the indicator light is in operation.



Before driving at night, check that the electrical equipment is operating correctly and adjust the headlight beams (if your vehicle is not carrying its normal load). As a general precaution, check that the lights are not obscured (by dirt, mud, snow or objects being transported).

Dipped beam headlights



Turn the **2** until the symbol is opposite mark **3**.

This indicator light on the instrument panel comes on.



Always make sure the windscreen is not obscured (dirt, mud, snow, condensation, etc.).

Main beam headlights



With the engine running and the dipped beam headlights on, push the stalk **1**. This indicator light on the in-

LIGHTING AND SIGNALS

strument panel comes on.

To return to the dipped beam headlights position, pull the stalk **1** towards you again.

Automatic main beam headlights

 Depending on the vehicle, this system switches the main beam headlights on and off automatically.

It uses a camera located behind the interior rear view mirror to detect vehicles that are being followed and those coming in the opposite direction.

Note: at night, in urban areas with street lighting, the automatic main beam headlights automatically switch off.

The main beam headlights come on automatically if:

- the exterior light level is low;
- no other vehicle or lighting is detected;
- the vehicle speed is above approximately 25 mph (40 km/h).

If any of the above conditions are not fulfilled, the system switches to dipped beam headlights.

Note: make sure that the windscreen is not obscured (dirt, mud, snow, condensation, etc.).

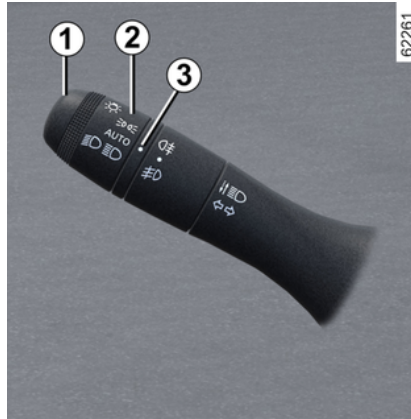

To activate the automatic main beam headlights

Turn ring **2** until the **AUTO** symbol is aligned with the mark **3**.

The indicator light  on the instrument panel lights up if the dipped beam headlights are on.

To deactivate the automatic main beam headlights

Turn ring **2**, until the  symbol is opposite mark **3**. The warning light

 will disappear from the instru-

ment panel and the main beam headlights will be activated.

 The system may encounter difficulties under certain conditions, including:

- extreme weather conditions (rain, snow, fog, etc.);
- obstruction in front of the windscreen or camera;
- when a following or oncoming vehicle has weak or hidden lighting;
- incorrect settings for the front headlights;
- reflecting systems;
- ...

Operating faults

When the "Check Automatic Lighting" message appears on the instrument panel, the system is deactivated.

Consult an approved Dealer.

Switching off the dipped beam headlights

There are two possibilities:

LIGHTING AND SIGNALS

– manually, move the **2** ring to posi-

tion  or, depending on the vehicle, to position **0**;

– the lights will go out automatically when the engine is switched off, the driver's door is opened or the vehicle is locked. In this case, when you start the engine the lights will be switched back on according to the position of the ring **2**, taking into account the exterior light level, without moving the stalk **1**.

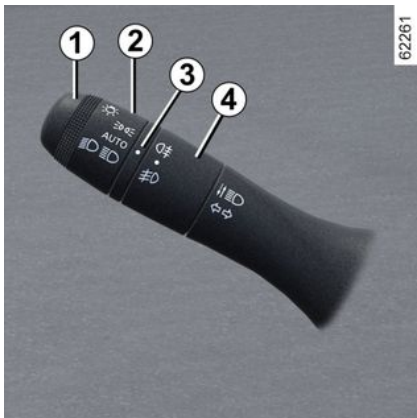

Front fog lights

(depending on the vehicle)

 With the engine running, turn centre ring **4** on the stalk **1** until the

symbol faces mark **3** then release it.

Depending on the vehicle, the stalk returns to the initial position or stays in position.

Operation of the fog lights depends on the exterior lighting selected, and an indicator light will light up on the instrument panel.

Rear fog light

 With the engine running, turn centre ring **4** on the stalk until the symbol faces mark **3**, then release it.

Depending on the vehicle, the stalk returns to the initial position or stays in position.

Operation of the fog lights depends on the exterior lighting selected, and an indicator light will light up on the instrument panel.

To avoid inconveniencing other road users, remember to switch off this light when it is no longer needed.

 When driving in fog or snow, or when transporting objects which are higher than the roof, the headlights do not come on automatically. The fog lights are controlled by the driver: indicator lights on the instrument panel inform you whether they are on (indicator light on) or off (indicator light off).

Turning off the fog lights

There are two possibilities:

- manually, depending on the vehicle, turn centre ring **4** again until mark **3** is opposite the symbol for the fog light that you wish to switch off. The corresponding indicator light will go out on the instrument panel;
- the lights will go out automatically when the engine is switched off or the vehicle is locked, and the fog lights when the driver's door is opened.

The front and rear fog lights switch off when the exterior lights are switched off.

Welcome and goodbye function

(depending on the vehicle)

LIGHTING AND SIGNALS

Once the function is activated, the daytime running lights and the rear side lights light up automatically on detecting the card or when the vehicle is unlocked and a beep sounds.

They switch off automatically:

- approximately one minute after lighting up;
- when starting the engine, based on the position of the lighting stalk;
- or
- upon locking the vehicle.

Activating/deactivating the function

To activate or deactivate the external welcome function, please see the multimedia instructions.

Choose "ON" or "OFF".

Lights-on reminder audible alarm

A warning beep sounds when the driver's door is opened to warn you that the lights are still on.



Before driving at night, check that the electrical equipment is operating correctly and adjust the headlight beams (if your vehicle is not carrying its normal load). As a general precaution, check that the lights are not obscured (by dirt, mud, snow or objects being transported).

Headlight beam adjustment



Switch **A** is used to adjust the height of the headlight beams according to the load.

With the dipped beam headlights on, press or raise switch **A** as many times as required to select the required position on the instrument panel.

The position selected is displayed on the instrument panel for approximately 30 seconds.

Note: depending on the vehicle, each time the ignition is switched on, the position selected is displayed on the instrument panel for approximately 30 seconds and for approximately 5 seconds each time switch **A** is pressed.

LIGHTING AND SIGNALS

Table of adjustment position examples

	Examples of positions for adjusting the control A according to the load			
	4x4 Combustion versions	4x2 Combustion versions	Hybrid4x4 versions	Hybrid4x2 versions
Driver alone or with front passenger	0	0	0	0
Driver with one front passenger and three rear passengers	1	1	1	1
Driver with one passenger in the front, three passengers in the back, and baggage (or load) reaching the maximum permissible all-up weight	2	2	2	2
Driver only and with luggage (or load) reaching the maximum authorised load weight	3	3	3	3

The table below gives some examples. In all cases, adjust the control **A** according to the vehicle load so that the road can be seen and other drivers are not dazzled.

AUDIBLE AND VISUAL SIGNALS

Horn



Press at one of the locations **1**.

Headlight flasher

Pull the stalk **2** towards you then release it to flash the headlights.

Direction indicators

With the engine running or the ignition on, move stalk **2** parallel to the steering wheel and in the direction you are going to turn it.

One-touch mode

Briefly shift the stalk **2** upwards or downwards, not exceeding the point of resistance, then release it: the stalk

will return to its original position and the direction indicator light concerned will flash three times.



Hazard warning lights

 Press the switch **3**.

This switch activates all four direction indicators and the side indicator lights simultaneously.

It must only be used in an emergency to warn drivers of other vehicles that you have had to stop in an area where stopping is prohibited or unexpected, or that you are obliged to drive under special conditions.

WIPER

Windscreen wash, wipe

2

Vehicle fitted with intermittent windscreen wipers



A a single sweep of the wipers

A short push will trigger one sweep of the wipers.

B off

C intermittent wiping

The wipers will pause for several seconds between sweeps.

D slow continuous wiping

E fast continuous wiping

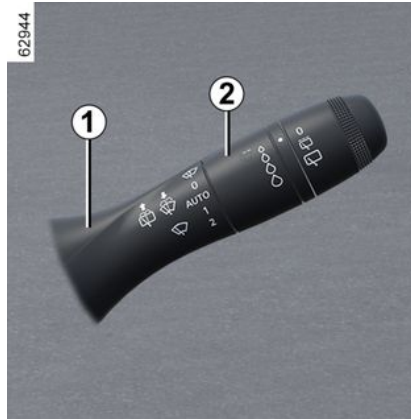

Special feature

When driving the vehicle, the wiping speed slows down whenever the vehicle stops. For example, fast wiping speed will slow to normal wiping speed. As soon as the vehicle moves off, wiping will return to the speed originally selected.

Any action on the stalk **1** overrides and cancels the automatic function.

Note: when washing the vehicle using a carwash, return the ring **2** on the stalk **1** to the off position in order to deactivate wiping.

Note: after use, remember to return the ring **2** on the stalk **1** to the off position in order to ensure that wiping is

not activated automatically upon the next use.

Vehicle fitted with front windscreen wiper rain sensor

The rain sensor is located on the windscreen, in front of the interior rear view mirror.

A a single sweep of the wipers

A short push will trigger one sweep of the wipers.

B off

C automatic wiper function (depending on the vehicle)

When this position is selected, the system detects water on the windscreen and triggers the wipers at a suitable wiping speed.

WIPER

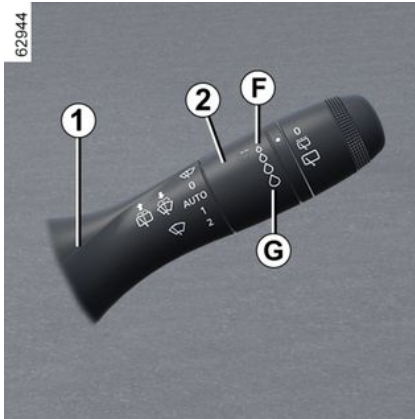

It is possible to change the triggering threshold and the interval between sweeps by turning the ring **2**:

- **F**: minimum sensitivity;
- **G**: maximum sensitivity.

The higher the sensitivity, the quicker the wipers will react and the faster the wipe.

When activating automatic wiping or when increasing sensitivity, one sweep of the blades is performed.

Note:

– the rain sensor is only intended as a driving aid. In the event of reduced visibility, the driver should manually activate the wipers. In foggy weather or during snowfalls, wiping is not auto-

matically triggered and remains under the driver's control;

- in the event of temperatures below zero, automatic wiping is not activated when the vehicle is started. It is automatically activated as soon as the vehicle exceeds a certain speed (approximately 5 mph (8 km/h));
- do not activate automatic wiping in dry weather;
- fully de-ice the windscreen before activating automatic wiping;
- when washing the vehicle under a roller type car wash, set the stalk **1** to position **B** to deactivate automatic wiping.

If your vehicle is equipped with a vehicle settings customisation menu, you can opt to activate or deactivate this function → 113.

For vehicles not fitted with a settings customisation menu, you can have this function deactivated by an authorised dealer.

Operating faults

In the event of a malfunction of the automatic wiping, the wiper is set to intermittent wiping. Call an approved dealer.

The rain sensor operation may be interrupted in the event of:

- damaged windscreen wipers: a film of water or traces left by a blade in the

sensor's detection zone may increase the response time of the automatic wiper, or increase the wiping frequency;

- a windscreen with any chip or crack near the sensor, or a windscreen covered in dust, dirt, insects, ice, the use of washing wax and water-repellent chemicals. In this case the windscreen wiper will be less sensitive or may even not react at all.

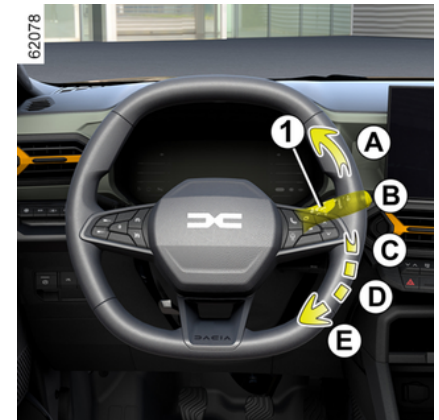

D slow continuous wiping

E fast continuous wiping

Special feature

When driving the vehicle, the wiping speed slows down whenever the vehicle stops. For example, fast wiping speed will slow to normal wiping

WIPER

speed. As soon as the vehicle moves off, wiping will return to the speed originally selected.

Any action on the stalk **1** overrides and cancels the automatic function.

Precautions

- In the event of ice, check whether the blades are stuck to the windscreen before operating the wiping mechanism. If you activate the wipers while the blades are stuck down with ice, you may risk damaging both the blade and the wiper motor.
- Do not activate the wipers on a dry screen. This will lead to premature wear or damage to the blades.

Specific front wiper position (service position)

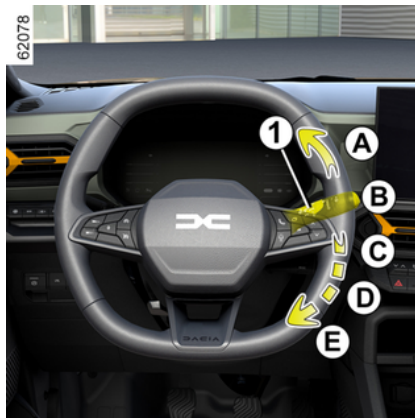

This position enables the blades to be lifted to remove them from the windscreen.

It may be useful to:

- clean the blades;
- release the blades from the windscreen in winter;
- replace the blades → **357**.

With the ignition on or engine started, lift the stalk **1** twice to position **A** (single sweep). The blades stop slightly away from the bonnet.

To return the blades to the lowered position, with the ignition on, ensure that the wipers have folded down onto the

windscreen, then move the stalk **1** to position **A** (single sweep).

Before switching on the ignition, place the wipers on the windscreen. Otherwise, there may be a risk of damage to the bonnet or the wipers when they are switched on.



Before any action involving the windscreen (washing the vehicle, de-icing, cleaning the windscreen, etc.) return the stalk **1** to position **B** (off).

Risk of injury and/or damage.



In the event of obstacles on the windscreen (dirt, snow, ice etc.), clean the windscreen (including the central area located behind the interior rear view mirror) before starting the wipers (risk of motor overheating). If an object is preventing a blade from moving, it may stop functioning. Remove the obstacle and re-activate the wiper using the wiper stalk.

WIPER

Windscreen washer



With the ignition on, pull the stalk **1** then release.

A longer pull will trigger, in addition to the windscreen washer, two sweeps of the wipers followed, a few seconds later, by a third.

Note: in temperatures below zero, the washer liquid may freeze on the windscreen, reducing visibility. Heat the windscreen using the demister control before cleaning.



When working in the engine compartment, ensure that the windscreen wiper stalk is in position

B (stop).

Risk of injury.



Efficiency of a wiper blade

Check the condition of the wiper blades. How long they last depends on you:

- it must remain clean: clean the blade and the screen regularly with soapy water;
- do not use it when the screen is dry;
- free it from the screen when it has not been used for a long time.

In all cases, replace it as soon as it begins to lose efficiency: approximately once a year → **357**.

Precaution for using the wipers

- In freezing or snowy conditions, clear the screen before starting the wipers (risk of motor overheating);
- ensure that no objects are obstructing the travel of the blade.

WIPER

Rear windscreen wash, wiper

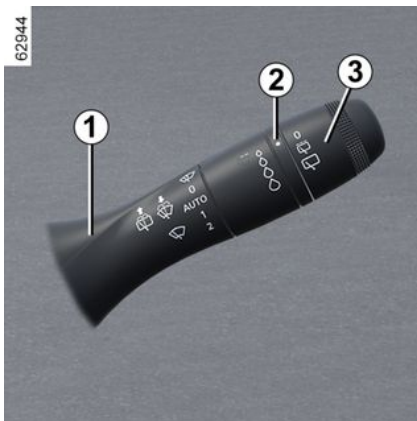

Rear windscreen wiper

 With the ignition on, rotate the ring **3** on the stalk **1** until the symbol is opposite the mark **2**.

- **off**
- **intermittent wiping**

The wipers will pause for several seconds between sweeps. The wiping frequency varies according to the vehicle speed;

- **slow continuous wiping**

To stop the operation, rotate the ring **3** again.

Note:

When washing using a roller type car wash, return the ring **3** on the stalk **1** to the stop position to deactivate wiping.

Note:

At the end of use, remember to return the ring **3** on stalk **1** to the off position, so that wiping is not inadvertently activated during the next use.



Do not use the wiper arm to open or close the tailgate.



Before taking any action involving the rear screen (washing the vehicle, de-icing, cleaning, etc.) return the stalk **1** to the off position.

Risk of injury and/or damage.



Efficiency of a wiper blade

Check the condition of the wiper blades. How long they last depends on you:

- it must remain clean: clean the blade and the screen regularly with soapy water;
- do not use it when the screen is dry;
- free it from the screen when it has not been used for a long time.

In all cases, replace it as soon as it begins to lose efficiency: approximately once a year → **357**.

Precaution for using the wipers

- In freezing or snowy conditions, clear the screen before starting the wipers (risk of motor overheating);
- ensure that no objects are obstructing the travel of the blade.

Activation/deactivation of the rear screen wiper

Engaging reverse gear triggers intermittent wiping (if the front wipers are in operation). If your vehicle is equipped with a vehicle settings customisation

WIPER

menu, you can opt to activate or deactivate this function ➔ 113.

For vehicles not fitted with a settings customisation menu, you can have this function deactivated by an authorised dealer.

In the event of obstacles present on the rear window (dirt, snow, etc.), the wiper will try to sweep away all the obstacles. If an obstacle prevents the blade from moving, it can be stopped. Remove the obstacle, wait for around 30 seconds and reactivate the wiper using the wiper stalk.

Precautions

- In the event of ice, check that the blades are not stuck to the windscreen before operating the wipers. If you activate the wiper while the blade is blocked by ice, you risk damaging both the blade and the wiping motor.
- Do not operate the wipers on a dry screen. This will lead to the premature wear or damage to the blades.



Rear screen wash/wipe



With the ignition on, push and hold the stalk **1** then release it.

Holding the stalk for longer will trigger (in addition to the windscreen washer) two sweeps of the wipers followed, a few seconds later, by a third (drip wiping function).

When the stalk is released, it returns to the rear wipe position.

FUEL TANK

Petrol and diesel versions

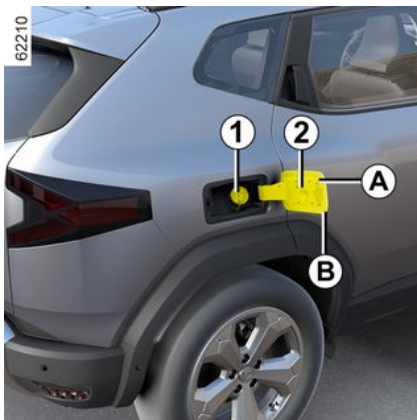

Useable capacity of the tank:

- About **11 gallons (50 litres)** for 4x2 versions.
- About **12.1 gallons (55 litres)** for 4x4 versions.

With the vehicle unlocked, to open the fuel filler flap **A**, place your finger in opening and pull the flap **B**. Open it, then unscrew the fuel filler cap **1**.

There is a cap holder **2** on the filler flap for holding the cap when the tank is being filled.

To close it, press the fuel filler flap **A** by hand, as far as it will go. Depending on the vehicle, cap **1** is connected

to the vehicle by a plastic wire. For details on filling the tank, refer to the information on "Filling with fuel".



Fuel filler cap: this is a specific type. If you have to replace it, make sure the new cap is of

the same type as the original. Contact an approved Dealer. Never place the cap near a source of heat or flame. Do not wash the filler area with a high-pressure washer.

Fuel grade

Always use a high-grade fuel that complies with the legislation in force in each country. It must conform to the specifications given on the label on the fuel filler flap → **375**.

Petrol version

It is essential to use unleaded petrol. The octane rating (RON) should match the information shown on the label located inside the fuel filler flap → **375**.

Diesel version

It is essential to use diesel that conforms to the specifications given on the label inside the fuel filler flap → **375**.



Fuels that comply with the European standards with which vehicle engines marketed in Europe are compatible → **375**.



To fill up with fuel, the engine must be switched off (and not only on standby in the case of vehicles equipped with the Stop and Start function): you must switch off the ignition → **149**, → **151**.

Fire hazard.

FUEL TANK



Do not mix even small amounts of petrol (unleaded or E85) with diesel.

Do not use ethanol-based fuel if your vehicle is not compatible with this fuel.

Do **not** add reagent to the fuel – otherwise you risk damaging the engine → 16. If you wish to add an additive to the fuel, use a product approved by our Technical Department.

Consult an approved Dealer.



No modifications whatsoever are permitted on any part of the fuel supply system (electronic unit, wiring, fuel circuit, injector, protective covers, etc.) as this may be dangerous (unless undertaken by qualified Network personnel).



Please note when working close to the engine that it may be hot. The engine cooling fan may also start at any moment. The



label in the engine compartment reminds you of this.

Risk of injury.

Filling with fuel

With the ignition off, insert the nozzle to fill the fuel tank (avoid the risk of splashing).

Keep the nozzle in this position throughout the entire filling operation. When the pump cuts out automatically at the end of the filling procedure, a maximum of two further filling attempts may be made, as there must be sufficient space in the fuel tank to allow for expansion.

Make sure that no water enters the fuel tank during filling.

After filling, refit the cap **1** and close the filler flap **A** to avoid any water or foreign bodies from entering the system.

Always make sure that the cap **1**, the flap **A** and its perimeter remain clean and free of dust, mud, dirt, etc.

Special case

When the vehicle has been stopped for around three months, **you must add fuel to prevent damage to the fuel pump.**

To do this, with the ignition off, fill up with fuel or add at least **approximately 2.20 gallons (10 litres)**, then start the engine to operate the pump and renew the fuel in the circuit.

If it is not possible to add at least 1.10 gallons (5 litres) of fuel due to the fuel level in the tank, drive the vehicle until the tank has capacity.

Petrol version

Using leaded petrol will damage the antipollution system and may lead to a loss of warranty.

To ensure that the fuel tank is not filled with leaded petrol, the fuel tank filler neck contains a restrictor fitted with a foolproof system which **only allows the nozzle for unleaded petrol to be used** (at the pump).

FUEL TANK

2



Persistent smell of fuel

If you notice a persistent fuel odour you should:

- stop the vehicle when traffic conditions allow it and switch off the ignition;
- switch on the hazard warning lights and ask your passengers to leave the vehicle and stay clear of the traffic;
- contact an authorised dealer.

At this point, do not attempt to carry on filling.

Filling up with LPG

Useful capacity of fuel tank LPG: approximately 51 litres.

Engage the handbrake, stop the engine, switch off the ignition and switch off the lights. Always respect the safety instructions given at filling stations.

Depending on the country, before refilling you must screw the filling adapter **3** on the LPG tank filler end piece.

It is always advisable to completely fill the tank.

When the pump stops delivering LPG, or when the pump flow reduces significantly, the maximum LPG level has been reached.

FUEL TANK

Filling stations without self-service

2

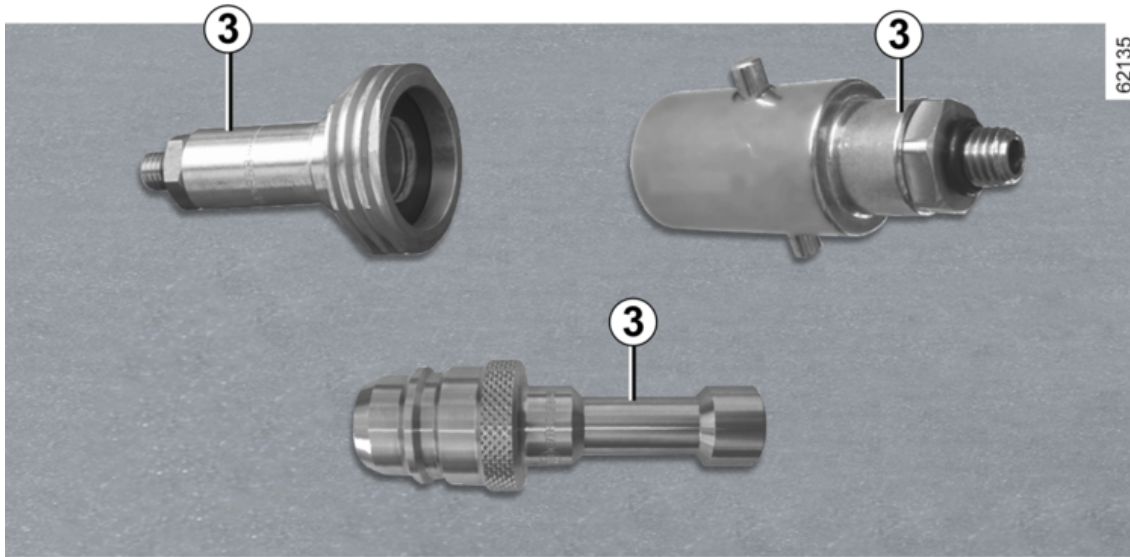

FUEL TANK

If the service station personnel carry out the LPG filling procedure, you must hand them the filling adapter **3**.

2



IMPORTANT: LPG filling adapter 3

Depending on the country, the use of a specific adapter is required for LPG filling.

The filling adapter **3** is provided in a pouch in the glove box. It may or may not be present in the vehicle, depending in which country the vehicle was sold.

Before driving the vehicle to another country, it is essential to consult an approved dealer to find out the type of adapter to use if necessary.

FUEL TANK

Filling stations with self-service

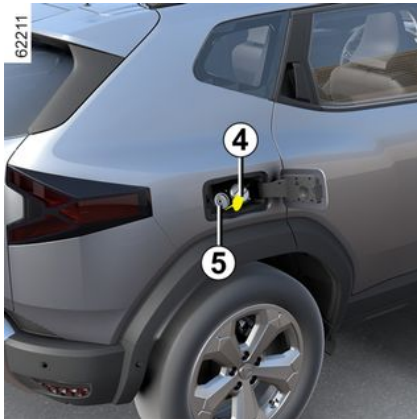

We recommend that you wear gloves when handling the LPG pistol.

Open your vehicle's fuel tank flap and unscrew the cap **4** from the LPG filler end piece **5**.

Carefully follow the information explaining how to refill using the LPG distributor.

Depending on the type of station, it may be necessary to perform press and hold the station button before filling will start.

When the pump stops or if it has difficulty operating, this means that the

maximum tank fill level (80%) has been reached.

The filling will stop as soon as you release the button. Release the stop lever (a small amount of gas may be released), lift the pistol and place it on the distributor.

After filling, refit the cap **4** to prevent any water or foreign bodies from entering the system.



To fill up with fuel, the engine must be switched off (and not only on standby in the case of vehicles equipped with the Stop and Start) function: you must switch off the ignition → **149** → **151**.

Fire hazard.

REAGENT TANK

Please ensure that you comply with the legislation of your country.

It is important to remember that failure to respect regulations in force could lead to legal action being taken against the vehicle owner.

Operating principle

The reagent is intended for Diesel engines fitted with the SCR (selective catalytic reduction) system.

Using a reagent reduces the quantity of nitrogen oxides in exhaust gases.

Reagent consumption in real time depends on vehicle usage conditions, the equipment fitted, and driving style.

Reagent quality

Use **only reagents which comply with the ISO 22241** standard and in accordance with the mark on the tank filler cap.



To fill up with reagent, the engine must be stopped (not just on standby in the case of vehicles with the Stop and Start function). You must switch off the ignition ➔ 149, ➔ 151.



If the "XXX miles (XXX km) LOCKOUT REFILL ADBLUE" message appears, fill the reagent tank and refer to the filling instructions.

Risk of immobilisation of the vehicle.

Topping up

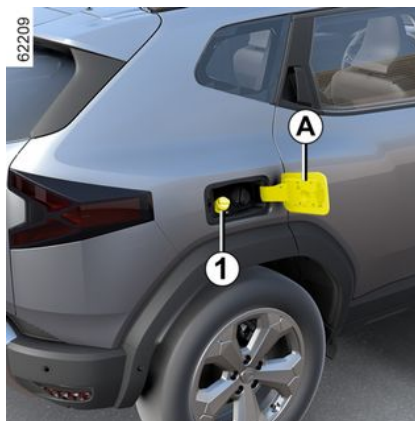

Useable capacity of the tank:

14 litres approximately.

With the ignition switched off, open the flap **A** then unscrew the cap **1**.

Note: ammonium hydroxide vapour may escape from the cap opening when the tank temperature is high.

The tank can be filled at the pump. With the ignition off, insert the nozzle and insert it **fully** before turning it on to fill the fuel tank (risk of splashing).

Keep the nozzle in this position throughout the entire filling operation.

When the pump cuts out automatically at the end of the filling procedure, a maximum of two further filling attempts may be made, as there must be sufficient space in the fuel tank to allow for expansion.

In other filling cases, it is essential to read the information shown on the reagent container (e.g. the can or bottle).



Fuel filler cap: this is a specific type.

If you have to replace it, make sure it is identical to the original cap. Contact an approved Dealer. Do not wash the filler area with a high pressure washer.

REAGENT TANK

Precautions for use

When filling:

- **handle the reagent with care. They can damage clothes, shoes, bodywork components etc.**
- make sure that no water enters the fuel tank.

If the reagent overflows, or contaminates any paintwork, clean the affected area quickly with plenty of cold water and a soft cloth.

Note: if the reagent fluid crystallises, use a soft sponge.



The reagent must not come into contact with eyes or skin. If it does, wash the affected area with plenty of cold water. If necessary, consult a doctor.

In extreme cold weather conditions in freezing conditions, fill the reagent tank as soon as the warning

light  and the "TOP UP AdBlue before 1200 km" message are displayed on the instrument panel.

Special cases

The reagent fluid freezes below approximately -10°C .

In these conditions, do not attempt filling when the fluid is frozen. In the event of needing to top up or fill the

tank with reagent ( on), park the vehicle in a hotter location if possible so that the reagent becomes liquid again. Otherwise, have a qualified professional top up or fill up with reagent fluid.



After filling the reagent tank, check that the cap and flap are closed, start the engine and **WAIT 10 seconds with the vehicle stationary and the engine running**, before setting off again.

If this operation is not carried out, the filling of the tank will not be taken into account automatically until after several dozens of minutes of driving.

The "---Fill AdBlue" message and/or the warning lights continue to be displayed until the system takes into account the filling status.





No work whatsoever is permitted on any part of the system. To prevent damage, only qualified personnel from our network may work on the system.

REAGENT TANK

Maintenance/Range

2

The information displayed on the instrument panel may be accompanied by a beep.







Indicator lights	Message	What to do?
-	« Top Up AdBlue before 2400 km »	When the message is displayed when the ignition is switched on, you have less than 1,488 miles (2,400 km) range . Fill or have an Approved Dealer fill or top up the reagent in the tank.
 comes on.	« TOP UP AdBlue before 1200 km »	When the message is displayed when the ignition is switched on, you have between 744 miles (1,200 km) and 496 miles (800 km) range . Fill or have an Approved Dealer fill or top up the reagent in the tank.
 comes on.	"xxxKm to lockout, fill Adblue"	The message is displayed when the ignition is switched on and is repeated: – approximately every 62 miles (100 km), you have a range of between 497 miles (800 km) and 124 miles (200 km) ; – Approximately every 31 miles (50 km), you have less than 124 miles (200 km) range . In any event, fill or have an Approved Dealer fill the reagent tank as soon as possible .
 comes on.	"0Km to lockout, fill Ad-blue"	The engine will not start. To restart, you must fill the reagent tank yourself.

REAGENT TANK

System faults

The information displayed on the instrument panel may be accompanied by a beep.

2

Indicator lights	Message	Readings
 and  illuminate.	« Check Anti- Pollution System » « AdBlue quality to check » « AdBlue injection to check »	Indicates a fault in the system. Contact your approved Dealer as soon as possible.
 and  illuminate.	"xxxKm to emission control lockout"	Indicates a system fault and that in less than 496 miles (800 km) it will become impossible to restart the vehicle. These warnings are repeated: – every 62 miles (100 km) until there are between 497 miles (800 km) and 124 miles (200 km) remaining until the vehicle cannot be restarted; – Every 31 miles (50 km) when there is less than 124 miles (200 km) left before the vehicle cannot be restarted. Contact your approved Dealer as soon as possible.
 and  illuminate.	"0 Km to emission control lockout"	Indicates that after the ignition is switched off the vehicle will not restart. Call an approved dealer.

RUNNING IN

Petrol version

For the first **620 miles** (1,000 km) do not exceed 80 mph (130 km/h) in the highest gear, or 3,000 to 3,500 rpm.

You can only expect top performance from your vehicle after approximately **1,860 miles (3,000 km)**.

Service intervals: refer to the vehicle's maintenance document.

Diesel version

For the first **930 miles (1,500 km)**, do not exceed 80 mph (130 km/h) in the highest gear, or 2,500 rpm. After completing this mileage you may drive faster, although you may only expect top performance after approximately 3,600 miles (6,000 km).

During the running in period, do not accelerate hard while the engine is still cold and do not let the engine over-rev.

Service intervals: refer to your vehicle's maintenance document.

Note: for a new vehicle in the running in phase, the coolant level may exceed the "**MAXI**" mark on the tank, then drop to between the "**MINI**" level and the "**MAXI**" level.

This does not present a risk.

3

STARTING, STOPPING THE ENGINE

Ignition-starter switch on a vehicle with key.

"Stop and steering lock applied" position A

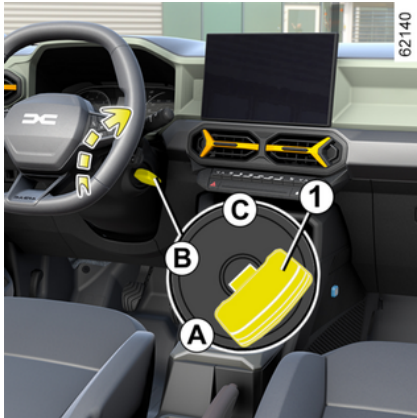

To lock: remove the key **1** and turn the steering wheel until the steering column locks.

To unlock: turn the key and the steering wheel slightly.

"On" position B

The ignition is switched on:

– **petrol version:** the engine may be started.

– **Diesel version:** the engine is pre-heating.

"Start" position C

If the engine fails to start at the first attempt, turn the key back before activating the starter again.

Release the key as soon as the engine starts.

Special note on vehicles with an automatic gearbox

➔ 159.

Starting the engine

Depending on the vehicle, if a gear is engaged, for the engine to be started, you must depress the clutch pedal or put the gear lever in neutral. The message "Select Neutral + Start" appears on the trip computer to notify you.

In very cold conditions (temperatures below -20°C): to make it easier to start the engine, switch on the ignition for several seconds **before** starting the engine.

In the event of starting the engine in very low exterior temperatures (below -10°C): hold down the clutch pedal until the engine starts.



Never start your vehicle while freewheeling on a gradient. Risk of non-activation of power-assisted steering.

There is a risk of accidents.

Petrol version

– Turn the key to the "Start" position **without depressing the accelerator pedal.**

– Release the key as soon as the engine starts.



Diesel version

– Turn the ignition key to the "On" position **B** and hold this position until the engine preheating warning light goes out.

– Turn the key to the "Start" position **C** **without accelerating.**

– Release the key as soon as the engine starts.

STARTING, STOPPING THE ENGINE

 During a system update via the multimedia system it will not be possible to start the vehicle. Wait for the update to be completed before starting the vehicle. For more information on system updates, please refer to the multimedia instructions.

Vehicles with an automatic gearbox

Before starting, set the lever to **P** or **N** position and press the brake pedal → 159.

Stopping the engine

With the engine idling, turn the key to the "Stop" position **A**.

Special feature

Depending on the vehicle, accessories (e.g. radio) stop working either when the engine is switched off or when the driver's door is opened or when the doors are locked.



Never start your vehicle while freewheeling on a gradient. Risk of non-activation of power-assisted steering.
There is a risk of accidents.

LPG version

The engine is always started using petrol.



While the fuel tank is empty, the vehicle cannot start or drive in LPG mode only.

Operation using LPG/petrol bi-fuel requires the presence of petrol (for starting, high acceleration, cold temperatures, etc.).

If the orange  warning light appears on the instrument panel accompanied by a beep, fill the tank with at least 1.76 gal (8 litres) of fuel.



For more information on LPG versions → 32.



Never switch off the ignition until the vehicle is stationary. Once the engine has stopped, the brake servo, power-assisted steering, etc., and the passive safety devices such as the airbags and pretensioners will no longer operate.



Do not park the vehicle or run the engine in locations where combustible substances or materials such as grass or leaves can come into contact with a hot exhaust system.

STARTING, STOPPING THE ENGINE



Driver's responsibility when parking or stopping the vehicle

Never leave an animal, child or adult who is not self-sufficient alone in your vehicle, even for a short time.

They may pose a risk to themselves or to others by starting the engine, activating equipment such as the electric windows or locking the doors.

Also, in hot and/or sunny weather, please remember that the temperature inside the passenger compartment increases very quickly.

RISK OF DEATH OR SERIOUS INJURY.

Version Hybrid

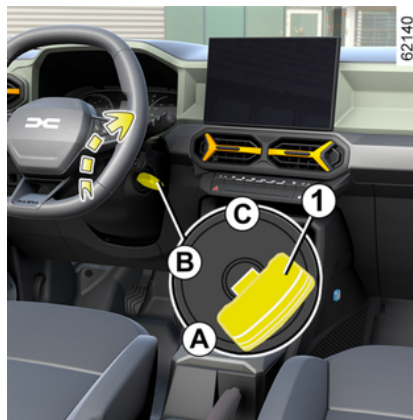

To switch on the ignition:

- shift the gear lever to **P** position;
- press the brake pedal;
- turn the key to the "Start" position **C** **without accelerating**;
- release the key as soon as the READY message appears on the instrument panel accompanied by a beep.

The message disappears when the vehicle speed is above approximately 3 mph (5 km/h).

Stopping the Hybrid system

With the vehicle stopped, turn the key to the "Stop" position **A**. The ignition is

switched off and the READY message disappears from the instrument panel.



Before leaving the vehicle, check that the ignition has been switched off.

Ignition-starter switch on a vehicle with card



Starting the engine

The card must be in the detection zone **2**.

STARTING, STOPPING THE ENGINE



To start:

- on a vehicle with an automatic gearbox, set the lever to **P** or **N** position, press the brake pedal and press button **1**. On Hybrid vehicles, the READY message is displayed on the instrument panel and is accompanied by a beep. The message disappears when the vehicle speed is above approximately 3 mph (5 km/h);
- on vehicles with a manual gearbox, press the brake pedal or clutch and press button **1**. If a gear is engaged, the vehicle may only be started by depressing the clutch pedal.

Special features

- If any of the starting conditions is not met, the "Press Brake + START" or

"Press Clutch + Start" or "Select Gearbox Position "P"" message is displayed on the instrument panel;

- in some cases, it will be necessary to move the steering wheel whilst pressing the start button **1** to help unlock the steering column: in this case the "Turn Steering Wheel + START" message will warn you.

Note:

- on vehicles equipped with a manual gearbox, in the event of engine stalling the "Press Clutch" message is displayed on the instrument panel. Fully press the clutch pedal to restart the engine;
- on Hybrid vehicles: the engine unit will switch off automatically after approximately 15 minutes if the vehicle has remained stationary and the driver's seat belt has not been fastened. If necessary, you can restart the engine by pressing the button **1** once.



During a system update via the multimedia system it will not be possible to start the vehicle.

Wait for the update to be completed before starting the vehicle.

For more information on system updates, please refer to the multimedia instructions.

LPG version

The engine is always started using petrol.



While the fuel tank is empty, the vehicle cannot start or drive in LPG mode only.

Operation using LPG/petrol bi-fuel requires the presence of petrol (for starting, high acceleration, cold temperatures, etc.).

If the orange  warning light appears on the instrument panel accompanied by a beep, fill the tank with at least 1.76 gal (8 litres) of fuel.

STARTING, STOPPING THE ENGINE



For more information on LPG versions → 32.

"Hands-free" starting with the luggage compartment open

In this case, the card should not be located in the luggage compartment, to prevent the risk of loss.



Driver's responsibility when parking or stopping the vehicle

Never leave an animal, child or adult who is not self-sufficient alone in your vehicle, even for a short time.

They may pose a risk to themselves or to others by starting the engine, activating equipment such as the electric windows or locking the doors.

Also, in hot and/or sunny weather, please remember that the temperature inside the passenger compartment increases very quickly.

RISK OF DEATH OR SERIOUS INJURY.

Accessories function



(switching on the ignition)

Once you have gained access to your vehicle, you may use some of its functions (radio, navigation, wipers, etc.).

To use the other functions, with the card in the passenger compartment, press the button **1** without pressing the pedals.

Operating faults



In certain cases, the hands-free card may not work:

- when the card battery is drained, flat battery, etc.
- the card is near to appliances operating on the same frequency (monitor, mobile phone, video game device, etc.);
- the vehicle is located in a high electromagnetic radiation zone.

The "Place card on zone + START" message appears on the instrument panel.

STARTING, STOPPING THE ENGINE



Depress the brake or clutch pedal, then place the **3** card on the **4** symbol. Press the button **1** to start the vehicle. The message goes out.

Special case of Hybrid vehicles

With the vehicle stationary and in electric operating mode, the "Active engine Switch off" message appears on the instrument panel accompanied by a beep if:

- the driver's seatbelt is not fastened;
- the bonnet is open;
- the driver's door is open.

Conditions for stopping the engine



The vehicle must be stationary, with the lever positioned to **P** for vehicles with an automatic gearbox. On Hybrid vehicles, the READY message is displayed on the instrument panel.

With the card in the vehicle, press the button **1**: the engine is switched off. On Hybrid vehicles, the READY message disappears from the instrument panel.

The steering column is locked when the driver's door is opened or the vehicle is locked.

If the card is no longer in the passenger compartment or if the card's battery is flat, when the vehicle is stationary and you try to switch the engine

off, the "Keycard absent : press/hold START" message appears on the instrument panel: press the button **1** for at least three seconds. If the card is no longer in the passenger compartment, make sure you can retrieve it before pressing and holding the button. Without the card, you will not be able to restart the vehicle.

With the engine switched off, any accessories being used (radio, etc.) will continue to function for approximately 10 minutes.

When the driver's door is opened, the accessories stop working.



Never switch off the ignition until the vehicle is stationary. Once the engine has stopped, the brake servo, power-assisted steering, etc., and the passive safety devices such as the airbags and pretensioners will no longer operate.

STARTING, STOPPING THE ENGINE



Do not park the vehicle or run the engine in locations where combustible substances or materials such as grass or leaves can come into contact with a hot exhaust system.



When you leave your vehicle, especially if you have your card with you, check that the engine is completely switched off.



Before carrying out any operation in the engine compartment, you must switch off the ignition.

Stop and Start function

This system enables a reduced fuel consumption and lower greenhouse gas emissions.

The system is activated automatically when the vehicle is started.

When driving, the system stops the engine (standby) when the vehicle is at a standstill.

The  warning light is displayed on the instrument panel.

Conditions for engine standby

The vehicle has set off from where it was parked;

For vehicles equipped with automatic gearboxes:

- the gearbox is in **D** or **N** position; and
- the brake pedal is pressed (sufficiently hard);

Depending on the vehicle, if the  warning light flashes and the "Press brake pedal" message appears on the instrument panel, this indicates that the brake pedal is not sufficiently pressed;

- and
- the accelerator pedal is not pressed; and
- the speed is zero.

The engine remains on standby if position **P** is selected, or if position **N** is selected with the handbrake engaged and the brake pedal released.

For vehicles equipped with manual gearboxes:

- the gearbox is in neutral; and
- the clutch pedal is released;

If the  warning light flashes, this means that the clutch pedal must be released completely.

For all vehicles:

The warning light  on the instrument panel is lit when the engine is on standby. The vehicle equipment remains operational while the engine is stopped.

When the engine switches to standby, the steering assistance may no longer be operational.

In this case it becomes operational again when the engine is no longer on standby or the speed exceeds approximately 1 mph (1 km/h) (downhill, slope, etc.).



If the engine is put in standby, the electronic parking brake (depending on the vehicle) is not applied automatically.

STARTING, STOPPING THE ENGINE



Keep your vehicle stationary when the engine is on standby (shown by

the warning light  on the instrument panel).



Before leaving the vehicle, the engine must be switched off (and not put on standby) → 149,

→ 151.

Preventing the engine from standing by

In certain situations, such as negotiating a crossroads for instance, it is possible (with the system activated) to keep the engine on so as to be ready to move off quickly.

For vehicles equipped with automatic gearboxes:

Keep the vehicle stationary without pressing too hard on the brake pedal.

For vehicles equipped with manual gearboxes:

Keep the clutch pedal pressed right down.



To fill up with fuel, the engine must be off (and not only on standby in the case of vehicles equipped with the Stop and Start function): you must switch off the ignition → 149, → 151.

Fire hazard.

Conditions for coming out of engine standby

For vehicles equipped with automatic gearboxes:

- when the driver's door is opened;
- or
- when the driver's seat belt is unfastened;
- or
- when the brake pedal is released, **D** position is engaged;
- or
- when the brake pedal is released, **N** position is engaged and the parking brake is released;
- or
- when the brake pedal is pressed again, **P** position is engaged or **N** position is engaged with the parking brake applied → 159;

or

– the accelerator pedal is pressed;

or

– when **R** position is engaged;

or

– when, depending on the vehicle, the gear paddles are used in manual mode (**M**).

For vehicles equipped with manual gearboxes:

– when opening the driver's door, without any gear engaged and the clutch pedal released;

or

– when unfastening the driver's seat belt, without any gear engaged and the clutch pedal released;

or

– the gearbox is in neutral position and the clutch pedal is slightly pressed;

or

– the engine is in gear and the clutch pedal is pressed right down.

Special note: Depending on the vehicle, if you switch off the ignition when



the engine is on standby, the warning light may be displayed for a few seconds on the instrument panel.

STARTING, STOPPING THE ENGINE



On vehicles equipped with a manual gearbox:

the restart may be interrupted if the clutch pedal is released too quickly while a gear is engaged.

Conditions preventing the standby of the engine

Certain conditions prevent the system from using the engine standby function, especially when:

- the driver's door is not closed;
- the driver's seat belt is not fastened;
- reverse gear is engaged;
- the bonnet is not locked;
- the outdoor temperature is too low or too high;
- the battery is not sufficiently charged;
- the difference between the vehicle interior temperature and the automatic climate control setpoint is too high;
- the Park Assist function is in operation;
- the altitude is too high;
- the slope is too steep for vehicles fitted with an automatic gearbox;
- the "Clear View" function is activated → 277;
- the engine temperature is too low;

- the emission control system is being regenerated;
- ...

The warning light  appears on the instrument panel to indicate that engine standby is not available.



The engine must be switched off (not put on standby) before any operation is carried out in the engine compartment.

You must switch off the ignition
→ 149, → 151.

Special feature of the automatic engine re-start

Under certain conditions, the engine can restart on its own in order to guarantee your safety and comfort.

This may occur when:

- the outdoor temperature is too low or too high;
- the "Clear View" function is activated → 277;
- the battery is not sufficiently charged;
- the vehicle speed is above 3 mph (5 km/h) (downhill slope, etc.);

- the brake pedal is pressed repeatedly or there is a braking system requirement;
- ...

The  warning light is displayed on the instrument panel to notify you of automatic engine restarting.



Before leaving the vehicle, the engine must be switched off (and not put on standby) → 149,

→ 151.

STARTING, STOPPING THE ENGINE

Deactivating, activating the function



Press the switch **1** to deactivate the function. The "Stop & Start deactivated" message appears on the instrument panel and the switch **1** indicator light is lit.

Pressing again will reactivate the system. The "Stop & Start Activated" message appears on the instrument panel and the switch **1** indicator light goes out.

The system is automatically reactivated each time the vehicle is started using the start button → 151.

Operating faults

When the "Check Stop & Start" message appears on the instrument panel accompanied by the illumination of the switch **1** indicator light, this indicates that the system is deactivated.

Consult an approved Dealer.



Special note: when the engine is on standby, pressing the switch **1** once will automatically restart the engine.

GEAR CONTROL

Gearstick



Selecting reverse gear

(vehicle stationary)

Vehicle with a manual gearbox: shift the lever to Neutral, then shift the lever to Reverse.

Observe the grid marked on the knob **1** and lift the ring **2** up against the knob in order to engage reverse gear.

Vehicles with an automatic gearbox:
→ 159.

The reversing lights will come on as soon as reverse gear is selected with the ignition on.

Automatic gearbox, electronic lever

Selector lever 1

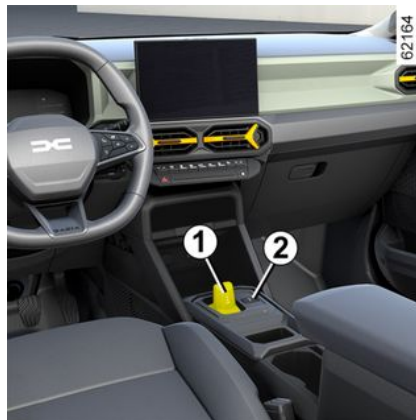

R: reverse gear

N: neutral

D: automatic mode

B: forward gear with increased regenerative braking (depending on the vehicle)

P: parking, button **2**

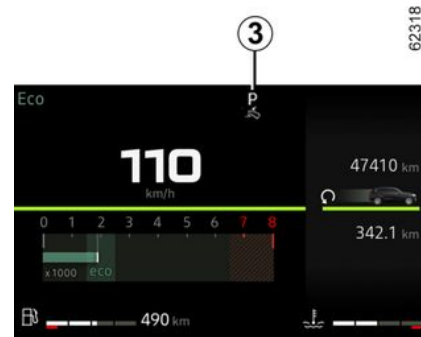

The **3** display on the instrument panel indicates the gear lever position engaged **1**.



Check that the **P** indicator light on the instrument panel and the indicator light built into the button **2** are displayed before leaving the vehicle.

Risk of loss of immobilisation of the vehicle

Operation

GEAR CONTROL

With the vehicle stationary and the selector lever **1** in **P** position, start the vehicle.

On the Hybrid version, the READY message appears on the instrument panel.

With your foot on the brake pedal (the warning light **4** disappears from the display), exit **P** position and engage **D** position.

The lever must only be shifted to D, B or R position while the vehicle is stationary, your foot is on the brake and the accelerator pedal is released.



The READY warning light is displayed on the instrument panel to indicate that the Hybrid system is in operation and ready for driving → 149, → 151.

Operation



Shift the selector lever **1** one or two notches forwards or backwards to engage the desired position (**R**, **N**, **D** or **B**), then release the lever and it will return to its stable position.

The position engaged lights up on the instrument panel.

If certain conditions prevent shifting from one position to another, the requested position flashes on the instrument panel.

To engage position P



With the vehicle stationary and the engine running or the ignition on, press the button **2** to engage **P** position. The warning light on button **2** appears in orange once the Park **P** position is engaged on the gearbox.

To disengage position P

With the vehicle stationary and the engine on, press the brake pedal and, move the **1** selector lever forwards or backwards according to the position desired. The **2** button warning light switches off.

If the brake pedal is not fully pressed, the "Press brake pedal" message and



warning light are displayed on the instrument panel.

GEAR CONTROL

Note:

– if the driver opens their door to leave the vehicle and **P** position has not been engaged, a beep sounds and the "P not engaged" message is displayed on the instrument panel;

– the warning light  appears each time the brake pedal must be pressed to change the automatic gearbox lever position.

To engage neutral

With the vehicle stationary and the engine running, to engage **N** position, shift the selector lever **1** a notch forwards or backwards according to the gear engaged.

Driving in automatic mode

With the vehicle stationary and the engine running, shift the selector lever **1** two notches backwards to engage **D** position.

If one of the conditions is not applied, **D** flashes for around five seconds and the "Press brake pedal" message is displayed on the instrument panel for approximately 15 seconds.

In the majority of driving conditions, you will no longer have to use your gear lever: the gears change "automatically", at the right time, to a suitable engine speed because the automated

system takes the vehicle's load, road profile and the selected driving style into account.

Note: with the engine running and the vehicle travelling at between 0 and 5 mph (0 and 8 km/h), in **N** or **R** position, you will have to press the brake pedal in order to engage **D** position. This is useful during parking manoeuvres requiring a number of alternate forward and reverse movements.

Economical driving

When driving, always leave the lever in position **D**, keeping the accelerator pedal lightly depressed to ensure automatic gear changes at a lower engine speed.

Accelerating and overtaking

Depress the accelerator pedal briskly and fully (so that it goes beyond the kickdown point).

This will enable you to change down to the optimum gear within the engine range.

Driving in mode B

This mode enables driving with greater regenerative engine braking.

When releasing the accelerator pedal, the vehicle uses regenerative braking to slow down.

Thus the electric motor generates a higher electrical current which enables the traction battery to be recharged.

In **B** mode, the regenerative braking performance will be reduced if the battery is cold or fully charged.



The engine brake should under no circumstances be used as a substitute for the brake pedal.

To select reverse gear

With the vehicle stationary and the engine running, shift the selector lever **1** two notches forwards to engage **R** position.

If the brake pedal is not pressed, a beep will sound, the **R** position display will flash for around five seconds on the grid shown on the instrument panel and the "Press brake pedal" message will be displayed for around 15 seconds.

Note: with the engine running and the vehicle moving at between approximately 0 and 5 mph (8 km/h), in **N** or **D** position you do not need to press the brake pedal to engage **R** position. This is useful during parking manoeuvres

GEAR CONTROL

requiring a number of alternate forward and reverse movements.

Gear change paddles 4 and 5



Depending on the vehicle, paddles **4** and **5** can be used to change gear when the selector lever **1** is in **D** position.

4: change to a lower gear.

5: change to a higher gear.

The **P**, **N** and **R** positions cannot be accessed using the paddles.

Driving in manual mode

When driving in **D** position, you can switch to manual driving mode using paddles **4** and **5** on the steering

wheel. Depending on the vehicle, two manual driving modes are available:

- the **"temporary" manual mode** can be used to force gear shifting by briefly pressing one of the two paddles. The driving mode **D** and the gear engaged appear on the instrument panel.

Note: the gearbox automatically returns to automatic mode **D** if the gear engaged is no longer optimal to vehicle performance or if no action has been taken on a paddle for a certain amount of time.

- **permanent manual mode is activated** by pressing and holding either of the paddles. The driving mode **M** and the gear engaged appear on the instrument panel.

Note: depending on the vehicle, the return to automatic mode is carried out by pressing and holding the right-hand paddle or by moving the one-touch lever **1** one or two notches backwards.

In all situations:

- to shift down through the gears, press the left-hand paddle;
- to move up through the gears, press the right-hand paddle.

Note: depending on the display, the

"+" and "-" or  and  indica-

tors will suggest that you shift up or down a gear.

Special cases

In certain driving conditions (resulting in, for example, engine protection, activation of the electronic stability control (ESC), etc.), the automatic system may change the gear automatically.

Likewise, to prevent incorrect manoeuvres, a gear change may be refused by the automatic system: in this case the gear display flashes for a few seconds as a warning.

Special circumstances

- **If the road type or weather conditions** (steep uphill slopes, sudden downhill slopes, deep snow, sand or mud) make it difficult to stay in automatic mode, depending on the vehicle, it is advisable to switch to manual mode using the paddles. This will prevent the "automatic gearbox" from changing gears repeatedly when driving uphill, and permit engine braking on long descents.
- **To avoid the engine stalling in very cold weather**, wait a few seconds before disengaging **P** or **N** position and shifting the lever to **D/B** or **R**.

GEAR CONTROL

Parking the vehicle

On vehicles equipped with lever **1**, **P** position is automatically engaged along with the electronic parking brake (if the vehicle is equipped), when:

- the engine is stopped;
- the driver's seatbelt is unfastened and the vehicle is stopped;
- the driver's door is opened and the vehicle is stopped.

P is displayed on the instrument panel and the **P** button lights up

As **P** position is **automatically engaged** when the engine is stopped, you may have to engage **N** position in some situations, for example in some car washes:

- with the engine running, press button **P**, shift the selector lever **1** a notch forwards or backwards then switch off the engine;
- with the engine off and the ignition on, move the selector lever **1** a notch forwards or backwards then switch-off the engine.

The next time the engine is restarted, **P** position is engaged automatically according to the cases described earlier.



The **P** position must only be engaged when the vehicle is stationary.



When facing uphill, to remain stopped, do not keep your foot on the accelerator.

Risk of overheating the automatic gearbox.



For safety reasons, do not switch off the ignition before the vehicle has come to a complete standstill.

Maintenance period

Refer to the maintenance document for your vehicle or consult an approved Dealer to check whether the automatic gearbox requires scheduled maintenance.

If it does not need to be serviced, there is no need to top up the oil.

Operating faults

– **When driving**, if the "WARNING: Check Gearbox" message appears on the instrument panel, it indicates a fault.

Contact your approved Dealer as soon as possible;

– **When driving**, if the "WARNING: Gearbox Overheating" message appears on the instrument panel, stop as soon as possible to let the gearbox cool down and wait for the message to disappear;

In the event of engine failure or an electrical fault (battery fault) affecting operation of the automatic gearbox, ensure that the vehicle is properly immobilised.

GEAR CONTROL



In the event an impact to the underside of the vehicle (e.g.: striking a post, raised kerb or other street furniture) this may result in damage to the vehicle (e.g.: twisted axle), the electrical circuit or the traction battery.

Do not touch the circuit elements or any fluids or liquids.

To prevent any risk of accident, have your vehicle checked by an authorised dealer.

Risk of serious injury or electric shock and risk to life.

3

SPECIAL FEATURES OF DIESEL VERSIONS

Diesel engine speed

When driving, to avoid damaging the engine, never let the engine speed exceed 4,500 rpm, regardless of which gear is engaged.

If the "Check Anti- Pollution System" message is displayed along with the



and warning lights, consult an approved dealer immediately.

When driving, depending on the grade of fuel used, it is possible that white smoke may be emitted.

This is due to the exhaust particle filter being cleaned automatically, and does not affect the way the vehicle runs.

Running out of fuel

After the tank has been filled following a **complete draining of fuel**, the fuel system → 138 must be reprimed before starting the engine.

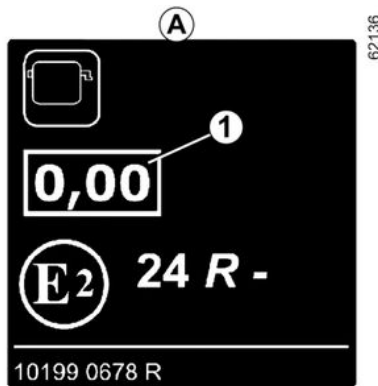

Engine smoke opacity label

You can find the information **1** on the label **A** affixed in the engine compartment or, depending on the vehicle, on the vehicle identification plate → 372.

1 Diesel exhaust emissions.

Precautions to be taken in winter

To avoid any faults in icy weather:

- ensure that the battery is always fully charged;
- always keep the diesel tank relatively full to avoid water vapour condensing in it and accumulating at the bottom of the tank.





Do not park the vehicle or run the engine in locations where combustible substances or materials such as grass or leaves can come into contact with a hot exhaust system.

Particle filter

The particle filter is used in the treatment of exhaust gases from diesel engines.

Depending on the vehicle, the warning

light  displayed on the instrument panel indicates that the filter is becoming clogged and requires cleaning.

To do this, when the  warning light is displayed, continue driving according to traffic conditions and observe the speed limit until the warning lights disappears. If possible, do not let the engine speed drop below 2000 rpm.

After between approximately 10 and 20 minutes, the warning light should go out.

SPECIAL FEATURES OF DIESEL VERSIONS

The display of the  on the instrument panel may be accompanied by an increase in engine speed and operation of the cooling system in order to clean the particle filter.

Note: the warning light may reappear if the driving conditions are not fully met with regard to cleaning the filter. If the vehicle is stopped or if the engine speed drops below 2,000 rpm before the warning light goes out, the operation may need to be repeated.



To facilitate the particle filter regeneration, carry out a long driving phase (at least 20 minutes) on main roads every 124 miles (200 km).

If the filter becomes saturated, the



warning light and, depending

on the vehicle, the  warning light appears on the instrument panel accompanied by the "Check injection" message. In this case, please consult an Authorised Dealer.

If the  warning light and, de-

pending on the vehicle, the  warning light appear accompanied by the "WARNING: Engine Failure Risk" message, stop the vehicle and contact an approved dealer.



For your own safety, the



warning light requires you to stop immediately, as soon as traffic conditions allow. Switch off the engine and do not restart it. Call an approved dealer.

SPECIAL FEATURES OF PETROL VERSIONS

The following operating conditions:

- driving for long periods when the low fuel level warning light is lit;
- using leaded petrol;
- using oil or fuel additives which are not approved by the manufacturer.

Or operating faults such as:

- a faulty ignition system, running out of fuel or disconnected spark plugs resulting in the engine misfiring or jerkiness while driving;
- loss of power,

as they may cause the catalytic converter to overheat and thus reduce its efficiency, **or damage it irreparably and cause heat damage to the vehicle.**

If you notice any of the above operating faults, have the necessary repairs carried out as soon as possible by an approved dealer.

These faults may be avoided by regularly taking your vehicle to your approved dealer at the intervals specified in your Maintenance Service Document.

Starting problems

To avoid damaging the catalytic converter or the starter, and to prevent premature battery wear, **do not** keep trying to start the engine (using the

start button, or by pushing or towing the vehicle) **without having identified and corrected the starting fault.**

If the fault cannot be identified, do not keep trying to start the engine, but contact an approved Dealer.



Do not park the vehicle or run the engine in locations where combustible substances or materials such as grass or leaves can come into contact with a hot exhaust system.

Particle filter

The particle filter is used in the treatment of exhaust gases from petrol engines.

Depending on the vehicle, the warning light  displayed on the instrument panel indicates that the filter is becoming clogged and requires cleaning. To

clean it, when the  warning light appears, and as traffic conditions and speed limits allow, drive at between about 31 mph (50 km/h) and 68 mph (110 km/h) until the light goes out.

After between approximately 5 and 20 minutes, the warning light should go out.

Note: the warning light may go out after 20 minutes if the driving conditions required to clean the filter are not fully met.

If the vehicle is stopped before the warning light disappears you will have to restart the process from the beginning.

If the filter becomes saturated, the



warning light and, depending

on the vehicle, the  warning light appears on the instrument panel accompanied by the "Check injection" message. In this case, please consult an Authorised Dealer.

If the  warning light and, de-

pending on the vehicle, the  warning light appear accompanied by the "WARNING: Engine Failure Risk" message, stop the vehicle and contact an approved dealer.

SPECIAL FEATURES OF PETROL VERSIONS



For your own safety, the

STOP warning light requires you to stop immediately, as soon as traffic conditions allow. Switch off the engine and do not restart it. Call an approved dealer.

3

PARKING BRAKE

Electronic parking brake

Assisted operation

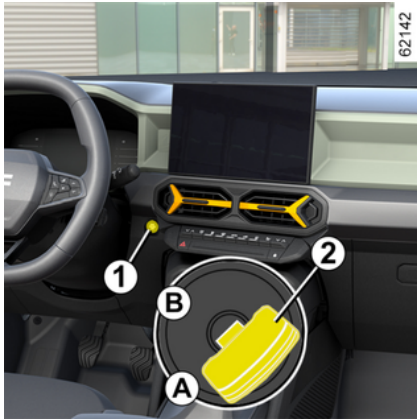

Applying the electronic parking brake

With the vehicle stationary, the electronic parking brake can be used to immobilise the vehicle:

– by pressing the engine start/stop button **1** or by turning the ignition key **2** (key in "Stop and steering lock applied" position **A**);

or

– when **the driver's seat belt is unfastened**;

or

– when **the driver's door is opened**;

or
– for vehicles equipped with an automatic gearbox, when **position P is engaged**.

In all other cases, for example when **the engine stalls or goes on standby due to the Stop and Start → 155 function**, the electronic parking brake is not applied automatically. Manual mode must be used.

For certain country-specific model versions, the assisted brake application function is not activated. See the information on "Manual operation".

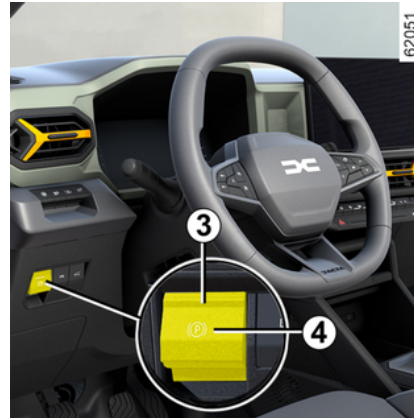

To confirm that the electronic parking brake is applied, the "Parking Brake

ON" message and the "Ⓟ" warning light appear on the instrument panel and the indicator light **3** lights up on the switch **4**.

After the engine is switched off, the indicator light **3** goes out a few minutes after the electronic parking brake has

been applied and the "Ⓟ" warning light goes out when the vehicle is locked.



Before leaving the vehicle, check that the electronic parking brake is fully applied. Warning light **3** on switch **4** and warning

light "Ⓟ" on the instrument panel illuminate to show that the parking brake is applied but switch off when the doors are locked.

Note: in some situations (electronic parking brake failure, manual release of the parking brake, etc.), to indicate that the electronic parking brake is released a beep sounds and the "WARNING: Apply Parking Brake"

PARKING BRAKE

message appears on the instrument panel:

- with the engine on: when the driver's door is opened;
- with the engine off (e.g. when the engine stalls): when a front door is opened.

In this case, pull and release the switch **4** to apply the electronic parking brake.

Assisted release of the parking brake

The parking brake is released as soon as the vehicle is started by accelerating or, on vehicles equipped with an automatic gearbox, with the ignition on, when shifting from **P position to R, N or D position**.

Manual operation

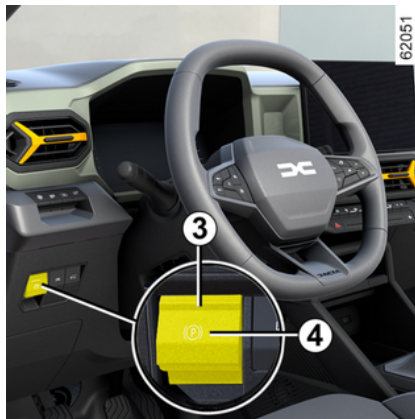

You can apply the electronic parking brake manually.

Manually applying the electronic parking brake

Pull the switch **4**. Warning light **3** and

warning light  on the instrument panel light up.

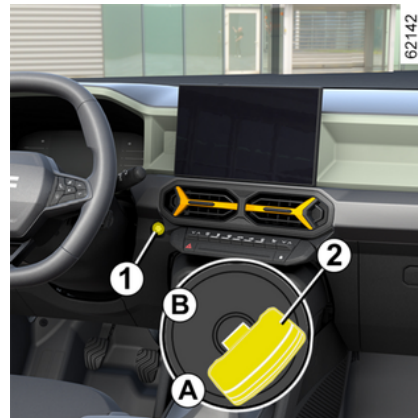

Manually releasing the electronic parking brake

To release the parking brake, press the **1** switch without pressing the pedals or turn the key **2** to the "On" position **B** to switch on the vehicle ignition. Press the brake pedal then press switch **4**: the indicator light **3** on the

switch goes out and the  warning light disappears from the instrument panel.

PARKING BRAKE



Before leaving the vehicle, check that the electronic parking brake is fully applied. Warning light **3** on switch **4** and warning

light **(P)** on the instrument panel illuminate to show that the parking brake is applied but switch off when the doors are locked.

Brief stop

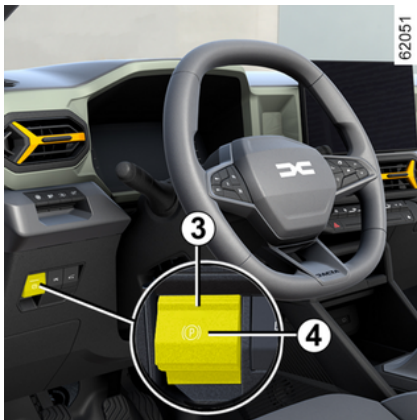

To apply the electronic parking brake manually (when stopping at a red light, stopping when the engine is running,

etc.): pull and release the switch **4**. The brake is released as soon as the vehicle is started up again.

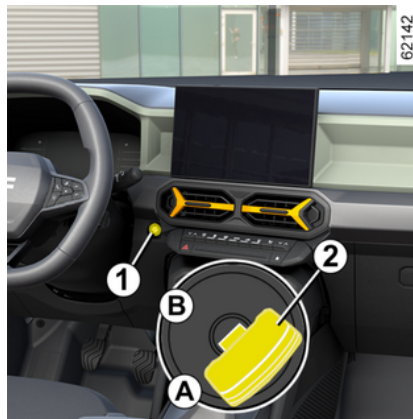

Special cases

To park on a slope or while towing a trailer, for example, pull switch **4** for a few seconds to enable maximum braking.

To park, with the electronic parking brake released (if there is a risk of freezing, for example):

- engage any gear or the **P** position: the drive wheels will be mechanically locked by the driveshaft;
- switch off the engine by pressing the engine start/stop button **1** or by turning the ignition key **2**;
- unfasten the driver's seat belt;

- open the driver's door;
- manually release the electronic parking brake (please see the paragraph on "Manually releasing the electronic parking brake");
- depending on the vehicle, the electronic parking brake is applied automatically. You will have to release it manually;
- close the driver's door and lock the vehicle.

Versions with an automatic gear-box

For safety reasons, automatic release is deactivated when the driver's door is open or not shut properly and the engine is running (in order to prevent the vehicle from moving without the driver). The "Release Parking Brake" message appears on the instrument panel when the driver presses the accelerator pedal.

PARKING BRAKE



Never leave your vehicle without moving the selector lever to position **P** and switching off the engine. This is because when the vehicle is stationary with the engine running and a gear engaged, the vehicle may begin to move if you accelerate.

There is a risk of accidents.



If the "WARNING: Electric System" or "Check battery" or "WARNING: Braking System" message appears, you must immobilise the vehicle by engaging the first gear (manual gearbox), **P** position (automatic gearbox) or by pulling the switch **4** for approximately 10 seconds.

If the conditions and the slope require it, chock the wheels of the vehicle.

Risk of loss of immobilisation of the vehicle.

Call an approved dealer.

Operating faults

– If there is a fault, the  warning light illuminates on the instrument panel accompanied by the "Check Parking Brake" message and, in some

cases, the  warning light.

Contact your approved Dealer straight away.

– If there is an electronic parking

brake fault, the  warning light comes on, along with the "Parking brake failure" message, a beep and, in

some cases, the  warning light.

This means that you must stop as soon as traffic conditions allow.



If no lights or sounds are apparent, this indicates a fault in the instrument panel. This indicates that it is essential to stop immediately (as soon as traffic conditions allow). Ensure that the vehicle is correctly immobilised and contact an approved Dealer.

Handbrake



To release

Pull the lever **2** upwards slightly, press the button **1** and lower the lever to the floor.

The warning light  on the instrument panel will go out.

The red warning light will appear on the instrument panel accompanied by a beep if you are driving with an incorrectly released parking brake (at a speed over 6 mph (10 km/h)).

67117

PARKING BRAKE



An impact to the underside of the vehicle (e.g. striking a post, raised kerb or other street furniture) may result in damage to the vehicle (e.g. deformation of an axle etc.).
To avoid any risk of accident, have your vehicle checked by an approved Dealer.



When stationary and depending on the slope and/or vehicle load, it may be necessary to pull up the handbrake at least two extra notches and engage a gear (1st or reverse gear) for vehicles with a manual gearbox or position **P** for vehicles with an automatic gearbox.

To apply:

Pull the lever **2** upwards and make sure- the vehicle is immobilised.

The warning light  on the instrument panel will come on.



Make sure that the handbrake is properly released when driving (red indicator light off), otherwise overheating, or even damage, may occur.

ENVIRONMENT

Your vehicle has been designed with respect for the **environment** in mind for its entire service life: during its production, usage and at the end of its service life.

3

Manufacture

Your vehicle has been manufactured at a factory which complies with a policy to reduce the environmental impact on the surrounding areas (reduction of water and energy consumption, visual and noise pollution, atmospheric emissions and waste water; sorting and reusing waste).

Emissions

Your vehicle has been designed to emit fewer greenhouse gases (CO₂) while in use, and therefore to consume less fuel (e.g. 160.9 g/mile (100 g/km), equivalent to 67.25 mpg (4.2 l/100 km) for a petrol vehicle or 225.3 g/mile (140 g/km), equivalent to 53.29 mpg (5.3 l/100 km) for a Diesel vehicle).

Our vehicles are also equipped with an emission control system including a catalytic converter, an oxygen sensor and an active carbon filter (the latter prevents vapour from the fuel tank being released into the open air), etc.

For certain diesel vehicles, this system also has a particle filter to reduce the volume of soot particles emitted.

Please make your own contribution towards protecting the environment too.

– Parts and vehicles at the end of their life must not be thrown away. They must be handed to a legal entity that complies with environmental standards.



61496

– Worn parts and components that are replaced during routine vehicle maintenance, such as tyres or oil (tanks emptied or filled) must be disposed of at dedicated collection points.

– Worn **electrical** and **electronic** components that are replaced (such as batteries) must not be thrown away as rubbish. Take them to an approved Dealer or consult your local authority for information on appropriate recycling facilities.

– To optimise the recycling of your vehicle at the end of its life, you can contact an authorised dealer or visit the manufacturer's website to be directed to collection points that guarantee respect for the environment complying with local laws.

Recycling

Your vehicle is at least 85% recyclable and at least 95% recoverable.

To achieve these objectives, many of the vehicle components have been designed to enable them to be recycled. The materials and structures have been carefully designed to:

– allow these components to be easily removed and reprocessed by specialist companies;
– promote a circular economy (re-use, recycling, recovery, etc.)

This is particularly true for electrified vehicle batteries.

In order to preserve raw material resources, your vehicle also includes

ENVIRONMENT

many parts made from recycled plastics or renewable materials.

MAINTENANCE AND ANTIPOLLUTION ADVICE

Your vehicle complies with criteria for recycling and recovering vehicles at the end of their service life, which entered into force in 2015.

Some of the parts on your vehicle have been designed to be recycled later.

These parts are easily removable in order to be collected and reprocessed in recycling networks.

Furthermore, by virtue of its design, moderate fuel consumption and initial settings, your vehicle also conforms to current anti-pollution regulations. The manufacturer is actively striving to reduce pollutant exhaust gas emissions and to save energy. But the fuel consumption of your vehicle and the level of pollutant exhaust gas emissions are also your responsibility. Ensure that it is maintained and used correctly.

Maintenance

It is important to remember that failure to respect antipollution regulations could lead to legal action being taken against the vehicle owner.

In addition, replacing engine, fuel supply system and exhaust components with parts other than those originally recommended by the manufacturer may alter your vehicle so that it no

longer complies with antipollution regulations.

Have your vehicle adjusted and checked by an approved dealer, in accordance with the instructions given in your maintenance schedule: they will have all the equipment necessary for ensuring that your vehicle is maintained to its original standard.

Engine adjustments

– **Spark plugs:** for optimum fuel economy, efficiency and performance, the specifications which have been laid down by our Design Department must be strictly applied.

If the spark plugs have to be changed, use the make, type and gap specified for your vehicle's engine. Contact an authorised dealer for this.

– **Air filter, fuel filter:** a choked element hinders performance. It must be replaced.

– **Ignition and idle speed:** no adjustment is needed.

Exhaust gas monitoring system

The exhaust gas monitoring system will detect any operating faults in the vehicle's exhaust gas antipollution system.

If this system malfunctions, toxic substances may be released into the at-

mosphere or mechanical damage may occur.



This indicator light on the instrument panel indicates possible faults in the system:

This lights up when the ignition is switched on and goes out when the engine is started.

- If it lights up continuously, contact an approved dealer as soon as possible;
- If it flashes, reduce the engine speed until the light stops flashing. Contact your approved Dealer as soon as possible;



➔ 144.

DRIVING ADVICE, ECO-DRIVING

The fuel consumption, along with energy consumption for the Hybrid version, is approved in accordance with the standard and regulatory procedures.

They are identical for all manufacturers and enable vehicles to be compared with one another.

Consumption in real time depends on vehicle usage conditions, the equipment fitted and the user's driving style.

To optimise fuel consumption, please refer to the following advice.

Depending on the vehicle, various functions are available to help you reduce your fuel or energy consumption:

- the rev counter;
- the gear change indicator;
- the driving style indicator;
- the journey record and eco-driving advice via the multimedia screen;
- acceleration indicator Eco;
- ECO mode;
- the Stop and Start ➔ 155 function.

On the Hybrid version, a charge meter is also available.

If fitted on the vehicle, the navigation system provides additional information.

On the instrument panel **A** or **B**

Depending on the vehicle, the information display can be organised and customised based on the instrument panel

customisation style selected from the multimedia screen.

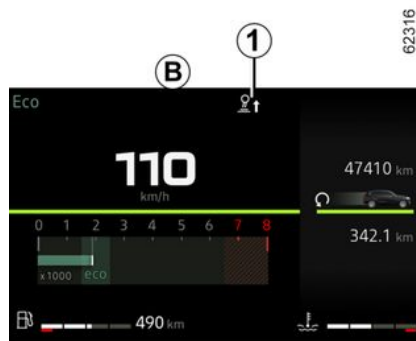

Gear change indicator 1

Depending on the vehicle, to obtain optimum consumption levels, a warning light on the instrument panel lets you know the best time to move up or down a gear:

 shift up a gear;

 downshift a gear.

If you regularly follow this indicator, you will reduce your vehicle's fuel consumption.

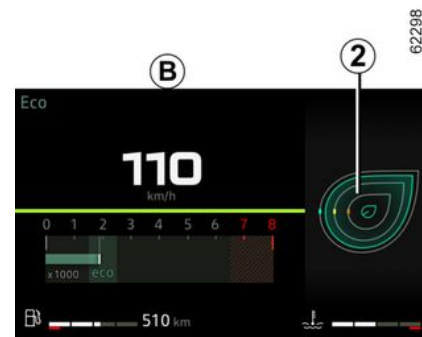

Driving style indicator 2

After activation, you will be informed about the driving style adopted in real time. You will be notified by indicator 2.

DRIVING ADVICE, ECO-DRIVING

The more petals displayed on the indicator **2**, the more your driving is flexible and economical.

If you regularly monitor this indicator, you will reduce your vehicle's fuel consumption.

Please refer to the multimedia instructions for further information.

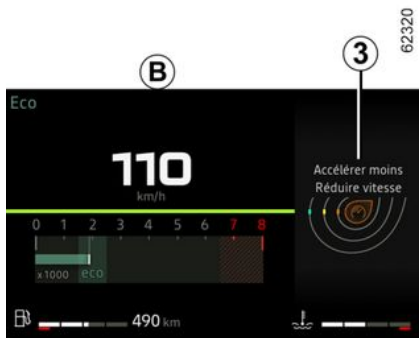

Acceleration indicator Eco 3

Depending on the vehicle, this informs you in real time whether you are accelerating moderately or strongly.

You will be notified by indicator **3**:

- green: acceleration is moderate and correct;
- white: acceleration is too high;
- grey: acceleration is high.

Note: it is not possible to simultaneously display the driving style indicator **2** and the acceleration indicator Eco **3**.

On the multimedia screen



Journey record

Once the engine is switched off, you will see "Journey record" displayed on the multimedia screen **4**, enabling you to view information on your last journey.

This indicates:

- general score;
- score evolution;
- distance without fuel consumption.

An overall rating from 0 to 100 is displayed to let you assess your eco driving performance.

The higher the rating, the lower the fuel consumption.

Eco advice is given to help improve your performance.

With your favourite journeys saved, you can compare your performance between trips and the performance of other vehicle users.

Please refer to the multimedia instructions for further information.

ECO mode

ECO mode is a function which optimises fuel consumption.

It affects certain driving operations (acceleration, shifting gears, cruise control, deceleration, etc.).

Limiting acceleration enables low fuel consumption in urban and surrounding areas.

DRIVING ADVICE, ECO-DRIVING



- by pressing switch **5** for 4x2 version;
- by turning the selector **6** to ECO position **7** on the 4x4 version;
- from the multimedia screen (refer to the multimedia instructions).

The warning light **Eco** comes on on the instrument panel to confirm activation.

While driving, it is possible to exit the ECO mode temporarily in order to improve engine performance.

To do this, press the accelerator pedal firmly and fully.

ECO mode is reactivated when you take pressure off the accelerator pedal.

Deactivating the function

Depending on the vehicle, the function can be deactivated either:

- by pressing switch **5** for 4x2 version;
- By turning selector **6** to another position for 4x4 version;

The warning light **Eco** goes out on the instrument panel to confirm deactivation.



Activating the function

Depending on the vehicle, the function can be activated either:

Charge meter



3

(on the instrument panel)

The charge meter gives the driver a real-time view of the vehicle's energy consumption.

Blue "Energy recovery" C usage zone

During driving, if you lift your foot off the accelerator pedal or press the brake pedal, the electric motor generates electrical current during deceleration and this energy is used to slow down the vehicle and recharge the traction battery.

"Energy consumption" D usage area

The colour of the charge meter varies:

DRIVING ADVICE, ECO-DRIVING

- **in green:** all-electric mode, the traction battery provides the energy required for the electric motor to power movement of the vehicle;
- **in white:** Hybrid traction mode, the traction battery and/or the combustion engine provide the energy required to power movement of the vehicle.

 The presence and display of this information depends on the type of ambient setting selected.

Maintaining the traction battery charge level: "E-Save"



To activate the function, press the **B** switch.

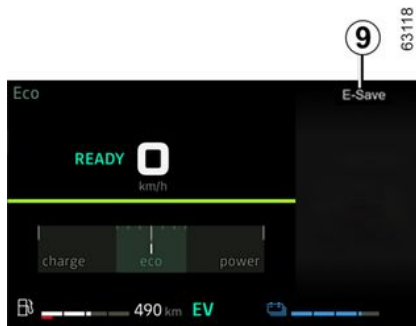

The warning light **9** comes on the instrument panel to confirm activation. This mode enables you to maintain a sufficient charge level in the traction battery in anticipation of a mountain road or a long motorway slope.

To deactivate the function, press the switch **B**. Warning light **9** goes out on the instrument panel to confirm deactivation.

Driving advice and Eco driving



Behaviour

- Drive carefully until the engine reaches its normal operating temperature, rather than let it warm up while the vehicle is stationary.

 **Vehicles equipped with 4x4 transmission (4WD)**
On flat, level ground, with the vehicle unladen, you are recommended to start in second gear.

- High speeds significantly affect the vehicle's fuel consumption.

DRIVING ADVICE, ECO-DRIVING

Examples (at a steady speed):

- reducing the speed from 80 mph (130 km/h) to 68 mph (110 km/h) approximately saves up to 20% of fuel approximately;
- reducing the speed from 56 mph (90 km/h) to 50 mph (80 km/h) approximately saves up to 10% of fuel approximately.
- Dynamic driving with a lot of frequent acceleration and braking is expensive on fuel in comparison to the time saved.
- Do not over rev the engine in the intermediate gears. You should always use the highest gear possible.
- Avoid sudden acceleration.
- Brake as little as possible. If you anticipate an obstacle or bend in advance, you may then simply release the accelerator pedal.
- Do not try to maintain the same speed up a hill, accelerate no more than you would on level ground. Keep your foot in the same position on the accelerator pedal.
- Double declutching and accelerating before switching off the engine are unnecessary in modern vehicles.
- Bad weather, flooded roads:



Do not drive through water if it is higher than the lower edge of the wheel rim.



Driver obstruction

On the driver's side, only use mats suitable for the vehicle, attached with the pre-fitted components, and check the fitting regularly. Do not lay one mat on top of another.

There is a risk of wedging the pedals.

Heating levels

It is normal to notice an increase in the vehicle's fuel consumption when using the heating (particularly when the outside temperature drops below zero) or air conditioning.

E

62137



3



The presence of label **E** in the vehicle will tell you that your vehicle has a greater ground clearance than an ordinary passenger vehicle. This gives it a higher centre of gravity, making it more susceptible to rolling during sudden or aggressive manoeuvres, or when cornering at high speeds. Take extra care when the vehicle is loaded (in particular when the load is on the roof). Ensure that all passengers are wearing their seat belts.

DRIVING ADVICE, ECO-DRIVING



4x2 (2WD) versions
The vehicle must not be used in off-road mode.

3

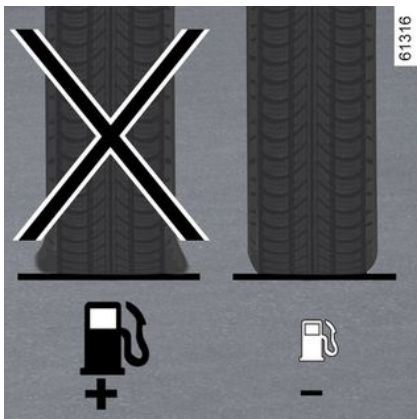

Tyres

- An underinflated tyre increases fuel consumption.
- To optimise fuel consumption, set the highest speed tyre pressure or the recommended pressure indicated on the edge of the driver's door → 327.
- The use of non-recommended tyres can increase fuel consumption.



Advice on use

- Favour the ECO mode.
- Electricity is fuel – switch off all the electrical components when they are not genuinely needed. **However** (safety first), keep your lights on when the visibility is bad ("see and be seen").
- Use the air vents. Driving with the windows open at 62 mph (100 km/h) will increase fuel consumption by 4%.
- Never fill the fuel tank right to the brim to avoid overflow.
- **On vehicles equipped with non-automatic air conditioning**, switch off the air conditioning when it is not required.

Advice for reducing consumption and helping to preserve the environment:

If the vehicle has been parked in the sun, open the doors for a few moments to let the hot air escape before starting the engine.

- Do not leave an empty roof rack fitted to the vehicle.
- It is better to fit a trailer for bulky objects.
- When towing a caravan, fit a wind deflector and adjust it carefully.
- Avoid using the vehicle for "door-to-door" calls (short journeys with long waits in between) because in such conditions the engine never reaches its optimal operating temperature.

TYRE PRESSURE LOSS WARNING

61319

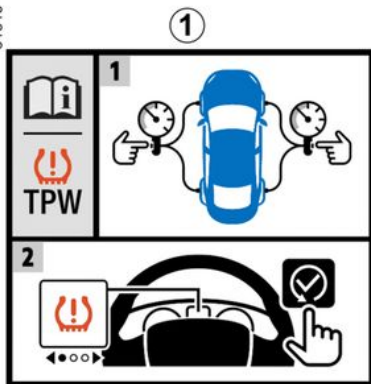

When fitted to the vehicle, this system notifies the driver if one or more tyres lose pressure.

The system can be identified by the **1** label in the vehicle.

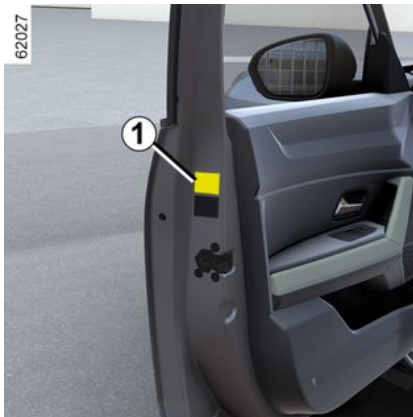

Operating principle

This system detects a loss of pressure in one of the tyres by measuring the wheel speed while driving.

The warning light  **2** comes on instrument panel to alert the driver in the event of insufficient pressure (tyre deflated, punctured etc.).

62109



This function is an additional driving aid. The function does not take the place of the driver. It cannot, therefore, under any circumstances replace the vigilance or the responsibility of the driver. Check the tyre pressures, including the emergency spare wheel, once a month.

Operating conditions

In order to provide a reliable warning in the event of significant pressure loss,

TYRE PRESSURE LOSS WARNING

the system must be reset with an inflation pressure equal to one of those shown on the tyre inflation pressure label (reference values) → **327**.

Resetting should always be carried out after checking the tyre pressure of all four tyres when cold.

In the following situations, the system risk coming into action late or not functioning correctly:

- system not reset after reinflation or any operation on the wheels;
- incorrectly reset system: tyre pressures different from the recommended pressures;

i The tyre pressure must be checked before starting the resetting procedure.

The system will not issue a warning if the pressure does not correspond to the recommended pressure.

- significant change in load or distribution of load on one side of the vehicle;
- sporty driving with strong acceleration;
- driving on snowy or slippery surface;
- driving with snow chains;
- fitting a single new tyre;

- use of tyres not approved by the network.

i The sudden loss of pressure in a tyre (burst tyre, etc.) cannot be detected by the system.

Procedure for resetting the standard levels for the tyre pressures

This should be performed:

- after each re-inflation or resetting of tyre pressure;
- after changing a wheel;
- after swapping a wheel (however, this practice is not recommended);

Tyre pressures must correspond to the current usage of the vehicle (empty, carrying a load, motorway driving, etc.). Respect the tyre pressures (including the emergency spare wheel). Check them at least once a month and before a long journey (refer to the label on the edge of the driver's door → **327**).



Vehicle not fitted with a multimedia screen

Ignition on, **vehicle stopped**:

- on vehicles equipped with a type **A** or **B** → **98** instrument panel, press switch **3** as many times as necessary to reach the "VEHICLE" tab;
- briefly press switch **4** or **5** to reach the "Tyre pressure init. long press" page;
- press and hold the **6** "OK" switch to launch the reset.

Hold down the **6** switch until the "Operation completed" message appears. You can now drive.

Vehicles fitted with a multimedia screen

TYRE PRESSURE LOSS WARNING

The resetting procedure must be carried out while the **vehicle is stationary** and the ignition is switched on.

Please refer to the multimedia instructions for further information.

TYRE PRESSURE LOSS WARNING

Possible messages

The table below shows the possible messages related to the tyre resetting procedure.

Steps	Messages	Readings
-	Tyre pressure init. at stop	The message is displayed during driving. If you want to reset the pressure of the four tyres, stop the vehicle.
1	Tyre pressure init. long press	To reset the pressure of the four tyres, with the vehicle stationary, press and hold the 6 "OK" switch to launch resetting until the "If pressure OK [hold on]" message is displayed.
2	If pressure OK [hold on]	The message flashes to indicate that the system has registered the resetting procedure. If all four tyres have been correctly adjusted to match the tyre pressure values recommended on the tyre pressure label → 327 , press and hold the 6 "OK" switch until the "Operation completed" message appears.
3	Operation completed	The resetting procedure has been completed successfully. You can now drive.

TYRE PRESSURE LOSS WARNING

Readjustment of tyre pressures

The pressure of the four tyres must be set when cold (refer to the label located on the edge of the driver's door).

If tyre pressures cannot be checked when the tyres are **cold**, the recommended pressures should be increased by **0.2 to 0.3 bar (3 PSI)**.

Never deflate a hot tyre.

After each reinflation or readjustment of the tyre pressure, launch the resetting of the tyre pressure reference value.

Replacing wheels/tyres

Only use equipment approved by the network.

Otherwise the system may come into action late or not function correctly
➔ **324**.

After each change of wheel/tyre, readjust the tyre pressure and launch the reset of the tyre pressure reference value.

Emergency spare wheel

If fitted on the vehicle, readjust the tyre pressure and launch the resetting of the tyre pressure reference value.

Tyre repair product and inflation kit

Only use equipment approved by the network.

Otherwise the system may come into action late or not function correctly
➔ **328**.





After using the tyre inflation kit, readjust the tyre pressure and launch the resetting of the tyre pressure reference value.

TYRE PRESSURE LOSS WARNING

Tyre pressure faults

The table below lists the warning messages which appear on the instrument panel when the system detects a tyre pressure fault.

The information on the instrument panel signals any potential tyre pressure faults (e.g. deflated or punctured tyre).

Indicator lights	Messages	Readings
 comes on (not flashing).	Inflate tyres and init.	This indicates that tyre under-inflation or puncture has been detected. Check and adjust the pressure of the four tyres when cold and reset the system.
 flashes, then stays on.	Check tyre press and init.	This indicates that the reset has been unsuccessful. Check and readjust the tyre pressure before re-launching the resetting procedure.
 flashes, then stays on, along with the warning light 	Check TPW	This indicates a fault in the system. Consult an approved Dealer.
 flashes, then stays on.	TPW not available	This indicates that an emergency spare wheel different in size to the other four wheels has been fitted to the vehicle. The system remains unavailable until a wheel identical in size to the other wheels has been fitted and the resetting procedure has been carried out.

TRANSMISSION: 4-WHEEL DRIVE

i Remember that driving a vehicle off-road is very different to driving it on the road. To make the most of your vehicle in an off-road situation, we recommend that you are trained to drive a 4x4 vehicle.

The safety of both you and your passengers is your responsibility, and depends on your skill and the care you take when driving off-road.

Driving mode selector



Depending on the type of roads or tracks you are taking and the external conditions, you can select from five driving modes:

- **"ECO" mode;**
- **"AUTO" mode** (default mode every time the vehicle is started);
- **mode "SNOW";**
- **mode "MUD-SAND";**
- **"OFF-ROAD" mode.**

All the modes are preset. Each of these modes is characterized by specific settings for:

- steering force;
- electronic stability control (**ESC** and traction control);
- accelerator pedal sensitivity and engine responsiveness;
- the engine torque distributed between the front and rear axles.

Turn the selector **2** to select the mode that best suits the driving and road conditions.

The selected mode is displayed on the instrument panel **1**.

i **Special cases**
Depending on the selected mode and the grip conditions encountered, the **ESC** intervention may reduce engine power to limit slipping of the drive wheels.

In some off-road situations, the user may choose to deactivate the ESC function in order to manage wheel slip and vehicle traction themselves.

"ECO" mode

Using **"ECO"** mode optimises fuel consumption.

It acts on some of the vehicle's energy-consuming systems (air conditioning, etc.) and on vehicle performance (acceleration, cruise control, deceleration, etc.)

Use this mode on paved roads.

TRANSMISSION: 4-WHEEL DRIVE



To activate this mode, turn the selector **2** to "ECO" position **3**: the light on the

selector comes on and the "ECO" warning light is displayed on the instrument panel **1** to confirm that it is activated.

"ECO" mode automatically distributes the engine torque between the front and rear axles according to the road-holding conditions and the vehicle speed.

Note: when driving (e.g. when overtaking), it is possible to temporarily regain the engine's optimum acceleration capabilities. To do this, press the accelerator pedal firmly and fully. "ECO" mode is reactivated when you ease off the accelerator pedal.

To change modes, turn the selector **2** to a different position. The "ECO" indicator light disappears from the instrument panel **1** to confirm deactivation and the newly activated is displayed.

"AUTO" mode

"AUTO" mode is the default mode to be used on the road.

It is a versatile mode that covers the majority of uses intended for the usual road conditions.

Use this mode on paved roads or when towing (trailer, caravan, etc.).



To activate this mode, turn the selector **2** to "AUTO" position **4**: the light on the selector comes on and the "AUTO"

indicator light is displayed on the instrument panel **1** to confirm that it is activated.

"AUTO" mode automatically distributes the engine torque between the front and rear axles according to the road-holding conditions and the vehicle speed.

This mode optimises road holding.

To change modes, turn the selector **2** to a different position. The "AUTO" display disappears from the instrument panel **1** to confirm deactivation and the newly activated mode is displayed.

"SNOW" mode

"SNOW" mode allows you to optimize your vehicle's electronic stability program on slippery roads (snow, ice, etc.).

The electronic stability control **ESC** and traction control interventions are enabled and the steering force is increased.

Use this mode on paved and slippery roads.

Note: the use of "SNOW" mode is not suitable in certain driving situations (on soft ground, deep snow, mud, sand, etc.).

TRANSMISSION: 4-WHEEL DRIVE



To activate this mode, turn the selector **2** to the **"SNOW"** position **5**: the light in the selector comes on.

The **SNOW** indicator light **1** lights up on the instrument panel to confirm activation.

"SNOW" mode automatically distributes the engine torque between the front and rear axles according to the road conditions and the vehicle speed.

To change modes, turn the selector **2** to a different position. The **"SNOW"** display disappears from the instrument panel **1** to confirm deactivation and the newly activated mode is displayed.

"MUD-SAND" mode

"MUD-SAND" mode allows you to make progress on soft ground in conditions of reduced grip (sand, mud, deep snow, etc.).

The "traction control" function is automatically deactivated to keep the engine speed under your control and help you move your vehicle forwards by probing the ground to find grippier areas.

Use this mode only off paved roads and on soft ground.



To activate this mode, turn the selector **2** to the **"MUD-SAND"** position **6**: the light integrated in the selector comes on and **"MUD-SAND"** is displayed on

the instrument panel **1** to confirm activation.

"MUD-SAND" mode distributes engine torque between the front and rear wheels in all grip conditions and under certain speed conditions.

To change modes, turn the selector **2** to a different position. The **"MUD-SAND"** display disappears from the instrument panel **1** to confirm deactivation and the newly activated mode is displayed.

"OFF-ROAD " (LOCK) mode

Using **"OFF-ROAD"** mode maximizes the performance capacity of your vehicle in off-road situations (rough or rutted roads, quagmire, soft sand, steep uphill and downhill slopes, etc.).

Use this mode only when off drivable roads and on difficult terrain.

3

TRANSMISSION: 4-WHEEL DRIVE



To activate this mode, turn the selector **2** to the "OFF-ROAD" position **7**: the light integrated in the selector comes on, "OFF-ROAD" is displayed and the

indicator light **4WD LOCK 1** appear to confirm activation.

"OFF-ROAD" mode distributes engine torque between the front and rear wheels in all grip conditions and under certain speed conditions.

To change modes, turn the selector **2** to a different position. The "OFF-

ROAD" display and the **4WD LOCK** indicator light disappear from the instrument panel **1** to confirm deactivation and are replaced by display of the newly activated mode.

Special features of the 4-wheel drive transmission

If the system detects a difference in size between the front and rear wheels (e.g. under-inflation, significant wear on an axle, etc.), the "4-wheel drive" system automatically switches to "2-

wheel drive" operation: the **2WD** warning light is displayed on the instrument panel **1** accompanied by the "4 wheel drive unavailable" message and, depending on the vehicle, "4 wheel drive unavailable unsuitable tyres".

Note: the problem may be resolved by replacing the tyres. Always use four identical tyres (same brand, profile, etc.) and with similar wear.

In the event of excessive stress resulting in abnormal overheating of the system:

- the **2WD** warning light is displayed on the instrument panel **1** accompanied by the "4WD Overheating (or 4x4)" message;
- if the wheels still spin, the system automatically switches to "2-wheel drive" operation to protect the mechanical components.

In this case, stop as soon as possible to allow the system to cool down. This cooling can last for several minutes.

When the 4WD (or 4x4) system is operational again, the **2WD** warning

light will switch off and the **4WD LOCK** warning light will be displayed again on the instrument panel.

Anti-lock braking in OFF-ROAD mode

(vehicles equipped with ABS)

When "OFF-ROAD" mode is activated, the ABS automatically switches to an off-road setting. In this case, the wheels may lock intermittently to achieve better grip and reduce braking distances on soft ground.

When "OFF-ROAD" mode is active:

- the vehicle's manoeuvrability is limited during braking. This operating mode is therefore not recommended in very low-grip conditions (e.g., ice);
- there may be some noise. This is normal, and does not indicate an operating fault.

TRANSMISSION: 4-WHEEL DRIVE

Electronic stability control (ESC) and traction control when driving off-road

(vehicles equipped with ESC)

When driving on soft ground (sand, mud, deep snow), we recommend that you deactivate the **ESC** function by pressing and holding the "**ESC**" button. In this case, only individual wheel braking remains active.

This function applies the brake to any wheel that is slipping, allowing the engine torque to be transferred to the wheels where there is the most grip. This is particularly useful when crossing a bridge.

All the **ESC** functions will be automatically reactivated when the vehicle speed exceeds approximately 31 mph (50 km/h), (62 mph (100 km/h) in "**OFF-ROAD**" mode) or after restarting the engine or pressing the "**ESC**" button again → 195.

Note: the traction control system is reactivated only after the engine is restarted or by pressing the "**ESC**" button.

Operating faults

When the system detects a malfunction, the system automatically switches

to "2-wheel drive" operation, the **2WD**

,  warning lights and the "Check 4 wheel drive" message appear on the instrument panel.

Drive as soon as possible at a moderate speed to an approved dealer.

TRANSMISSION: 4-WHEEL DRIVE

Warnings



4-wheel drive system

- Regardless of the mode selected, do not start the engine if all four wheels are not on the ground.
- Do not turn the mode selector when cornering, reversing or if the wheels are spinning excessively.
- The "**MUD-SAND**" and "**OFF-ROAD**" modes are exclusively reserved for driving **off-road**. The use of this mode in any other conditions may adversely affect the vehicle's manoeuvrability and damage certain mechanical components.
- Always ensure tyres with identical specifications are fitted to all four wheels (brand, size, structure, wear etc.). Fitting tyres of different sizes to the front and rear wheels and/or left and right wheels may have serious consequences for the tyres and **mechanical drive components** (gearbox, transfer box, **4WD (or 4x4) coupler**, rear differential, etc.).

DRIVER CORRECTION DEVICES AND AIDS

Depending on the vehicle, they may include:

- the **ABS (anti-lock braking system)**;
- **emergency brake assist**;
- **of the electronic stability programESC with understeer control and traction control**;
- **hill start assistance**;
- **deceleration speed control**;
- **multi-collision braking**.



These functions are an additional aid in the event of critical driving conditions, enabling the vehicle behaviour to be adapted to suit the driving conditions. The functions do not take the place of the driver. **They do not increase the vehicle's limits and should not encourage you to drive more quickly.** Therefore, they can under no circumstances replace the vigilance or responsibility of the driver when manoeuvring the vehicle (the driver must always be ready for sudden incidents which may occur when driving).

ABS (anti-lock braking system)

Under heavy braking, the ABS prevents the wheels from locking, allowing the stopping distance to be managed and keeping control of the vehicle.

Under these circumstances, the vehicle can be steered to avoid an obstacle whilst braking. In addition, this system can increase stopping distances, particularly on roads with low surface grip (wet ground etc.).

You will feel a pulsation through the brake pedal each time the system is activated. The ABS does not in any way improve the vehicle's "physical" performance relating to the road surface and roadholding. It is still **essential** to follow the rules of good driving practice (such as driving at a safe distance from the vehicle in front etc.).

Special feature of 4-wheel drive vehicles



In "4WD LOCK" mode, the system may lock the wheels briefly to optimise the braking distance on very wet ground (snow, mud, sand, etc.).



In an emergency, apply **firm and continuous pressure** to the brake pedal.

There is no need to pump it repeatedly. The ABS will modulate the force applied in the braking system.

Operating faults:

–  and  lit up on the instrument panel accompanied by the "Check ABS", "WARNING: Check Braking System" and "Check ESC" messages: this indicates that the ABS, the ESC and the Emergency Brake Assist functions are deactivated. **Braking is still provided;**

– , ,  and

 lit on the instrument panel accompanied by the "WARNING: Braking System" message: **this indicates a fault with the braking system.**

In both cases, please contact an approved Dealer.

DRIVER CORRECTION DEVICES AND AIDS



For your own safety, the

STOP warning light requires you to stop immediately, as soon as traffic conditions allow. Switch off the engine and do not restart it. Call an approved dealer.



Your braking systems are partially operational. However, **it is dangerous to brake suddenly** and it is essential to stop immediately, as soon as traffic conditions allow. Call an approved dealer.

Emergency brake assist with electronic brake distribution

(depending on the vehicle)

This system supplements the ABS and helps reduce vehicle stopping distances.

Operating principle

The system is for detecting an emergency braking situation. In this case, the braking assistance immediately develops maximum power and may trigger ABS regulation.

ABS braking is maintained as long as the brake pedal is applied.

Electronic stability control ESC with understeer control and traction control

Electronic stability control ESC

(depending on the vehicle)

This system helps you to keep control of the vehicle in critical driving conditions (avoiding an obstacle, loss of grip on a bend, etc.).

Understeer control

This system optimises the action of the ESC in the case of pronounced understeering (loss of front axle road holding).

Traction control

This system helps to limit wheelspin of the drive wheels and to control the vehicle when pulling away accelerating or decelerating.

Disabling the ESC function

(depending on the vehicle)



In some situations (driving on very wet ground: snow, mud, sand, etc. or driving with snow chains fitted), the system may reduce the engine output to limit wheelspin. If this is not required, it is possible to deactivate the function by pressing and holding the switch **1**.

The  warning light on the instrument panel comes on to warn you of this. **If you deactivate this function, the traction control system will also be deactivated.**

As the electronic stability program ESC with understeer control and trac-

DRIVER CORRECTION DEVICES AND AIDS

tion control provide additional safety, you are advised not to drive with the function deactivated. Get out of this situation as soon as possible by pressing the switch **1** again.

Note: the function is reactivated automatically when the ignition is switched on or when a speed of approximately 31 mph (50 km/h) is exceeded.

Operating principle

A sensor in the steering wheel detects the direction selected by the driver.



Other sensors throughout the vehicle measure the actual direction.

The system compares driver input to the actual trajectory of the vehicle and corrects the trajectory if necessary by controlling the braking of certain wheels and/or engine power. In the event that the system is engaged, indi-

cator light  flashes on the instrument panel.

Operating faults

If the system detects an operating

fault, the  and  warning lights appear on the instrument panel and, depending on the vehicle, the "Check ESC" message is displayed on the instrument panel. In this case, the electronic stability program ESC with

understeer control and traction control are deactivated.

Please consult an authorised dealer if these warning lights remain displayed on the instrument panel after the ignition is switched off and on again.

Disabling the traction control system

(depending on the vehicle)

Deactivating using button **1**

In some situations (driving on very wet ground: snow, mud, sand, etc. or driving with snow chains fitted), the system may reduce the engine output to limit wheelspin. If this is not required, it is possible to deactivate the function by pressing and holding the switch **1**.

In this case, the  warning light appears on the instrument panel accompanied by the "Traction control off" message.

The traction control system offers additional safety. It is recommended that you do not drive with the function disabled. Get out of this situation as soon as possible by pressing the switch **1** again.

Note: the function is reactivated automatically when the ignition is switched

on or when a speed of approximately 31 mph (50 km/h) is exceeded.

Deactivating from the multimedia screen **2**

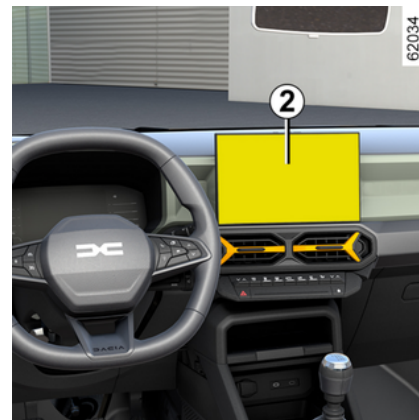

Depending on the vehicle, while the ignition is on you can deactivate the system via the multimedia screen **2**.

Please refer to the multimedia instructions for further information.

Hill start assistance

Depending on the gradient of the incline, this system assists the driver when starting on a hill. It prevents the vehicle from rolling backwards by automatically applying the brakes when the

DRIVER CORRECTION DEVICES AND AIDS

driver lifts his/her foot off the brake pedal to depress the accelerator pedal.

System operation

It only operates when the gear lever is in a position other than neutral (other than **N** or **P** on an automatic gearbox) and the vehicle is completely stationary (brake pedal pressed).

The system holds the vehicle for approximately **2 seconds**. The brakes are then released (the vehicle will move according to the slope).

If the system detects an operating

fault, the  warning light and, depending on the vehicle, the "Check Hill Start Assist" message is displayed on the instrument panel. Consult an approved Dealer.



The hill start assistance system cannot completely prevent the vehicle from rolling backwards in

all situations (extremely steep gradients etc.).

In all cases, the driver may depress the brake pedal to prevent the vehicle from rolling backwards.

The Hill Start Assist function should not be used for prolonged stops: use the brake pedal.

This function is not designed to immobilise the vehicle permanently.

If necessary, use the brake pedal to stop the vehicle.

The driver must remain particularly vigilant when driving on slippery or low-grip surfaces.

Risk of serious injury.

Hill descent control

This function enables the vehicle speed to be limited without depressing the brake pedal (when driving down a steep hill).

The hill descent control operates between 3 and 19 mph (5 and 30 km/h).

Note: when the vehicle speed exceeds 37 mph (60 km/h), the system is dis-

abled and the  warning light disappears.

Activation/deactivation from the multimedia screen 2

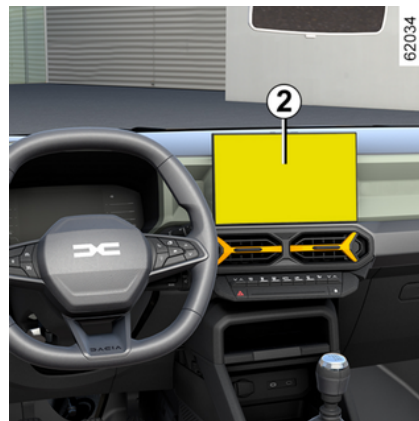



Depending on the vehicle, with the ignition on, you can activate/deactivate the system via the multimedia screen **2**.

Please refer to the multimedia instructions for further information.

DRIVER CORRECTION DEVICES AND AIDS

Activating/deactivating using the button 3



- **Activation:** press the button 3. The  warning light appears in white on the instrument panel.
- **Deactivation:** press the button 3 again. Warning light  goes out.



This system does not operate if the gear lever is in **P** position on vehicles fitted with an automatic gearbox, or if the vehicle is travelling on flat ground.

Operation

With the vehicle moving downhill at a speed below 19 mph (30 km/h), driving forwards or in reverse (**D** or **R** position on vehicles equipped with an automatic gearbox).

Once a sufficient gradient is detected,

the  warning light appears in green on the instrument panel.

During activation of the hill descent control system is, the speed of descent can be increased with the accelerator pedal or decreased with the brake pedal.



In the event of a fault on the vehicle hill descent control, use the brake pedal to stop the vehicle.

The driver must remain particularly vigilant when driving on slippery or low-grip surfaces.

Risk of serious injury.

Multi-collision braking

Multi-collision braking reduces the risk of an additional collision after an accident by temporarily bringing your vehicle to a standstill.

Operating principle

If the airbag system detects a collision, the pretensioners or airbags are triggered → 63 and the "Multi-collision braking" function activates the Electronic Stability Control (ESC) to brake the vehicle.

Multi-collision braking is deactivated during operation if:

- the driver presses the accelerator pedal firmly;
- and/or
- the braking force generated by the driver pressing the brake pedal is greater than the force produced by the automatic braking triggered by the function.

Note: multi-collision braking requires the proper functioning of your vehicle's braking system.

Operating faults

When the system detects an operating fault, the "Check Post-collision" mes-

sage and the  warning light appear on the instrument panel.

In this case, the function is deactivated. Consult an approved Dealer.

ADDITIONAL DRIVING AID FUNCTIONS

My Safety

The "My Safety" function can be used to deactivate or activate a set of driving assistance functions simultaneously.

Depending on the vehicle, you can configure the "My Safety" function from the multimedia screen or from the instrument panel by selecting the driving aid functions to be switched off as a group.

Operation



"ALL ON" mode

Depending on the vehicle, this mode includes the following driving assistance functions:

- overspeed sound alert → 228;
- lane departure prevention → 201;
- driver vigilance warning → 226;
- blind spot warning → 209;

When "ALL ON" mode is activated: the indicator light on button **1** lights up and the "My Safety All ON selected" message appears on the instrument panel to confirm this. The driving aids that are available in the mode are activated.

"Perso" mode

This mode can be used to **deactivate** or **reactivate** some driving aid functions that are available in the "ALL ON" mode previously configured via the "My Safety Perso" settings.

With the ignition on, **press** button **1** twice in succession to activate "Perso" mode.

The first time you press it, the "Press again for My Safety Perso" message appears on the instrument panel. On the second press, the indicator light on the button **1** goes out. "Perso" mode is activated. The "My Safety Perso selected" message is displayed on the instrument panel.

To switch back to "ALL ON" mode, **press once** on button **1**. The indicator light on button **1** lights up.



Depending on the vehicle and on the length of time since the last time the engine was stopped, the "ALL ON" mode is reactivated:

- when the vehicle is unlocked;
- or
- when a door is opened;
- or
- when the engine is restarted.

Configuration of My Safety Perso



For safety reasons, carry out any adjustments while the vehicle is stationary.

ADDITIONAL DRIVING AID FUNCTIONS



The "My Safety Perso" settings saved for "Perso" mode are stored each time the engine is or when the doors are locked.

Configuration from the multimedia screen 2

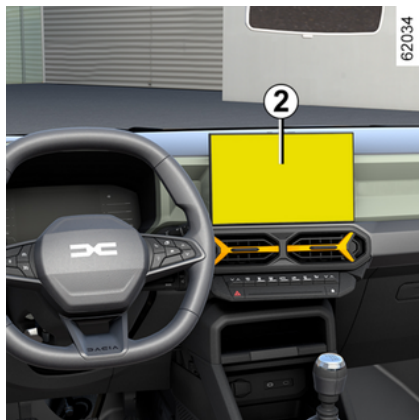

Refer to the multimedia instructions for information on accessing the settings.

Configuration from the trip computer

(depending on the vehicle)



– With the vehicle stationary, press the switch **3** as many times as re-

quired to reach the  tab;

or

– press control **3** and repeatedly press

control **4** or **5** to reach the  tab;

– press switch **6** "OK";

– repeatedly press control **4** or **5** to

reach the  menu, then press the **6** "OK" switch;

– repeatedly press control **4** or **5** to reach the "MY SAFETY PERSO" menu, then press the **6** "OK" switch;

– select the driving aids to be deactivated or activated from "Perso" mode by repeatedly pressing control **4** or **5**,

then press the **6** "OK" switch to deactivate or activate the driving aids.

Lane departure prevention



Using information from the **1** camera, the function triggers corrective action on the vehicle steering system when a continuous or broken line is crossed or when approaching the roadside (divider, barrier, pavement, embankment, etc.) without activating the direction indicator lights.

Depending on the setting, in the event of crossing a broken line without activating the direction indicator lights, the function:

– warns the driver without corrective action on the steering system;

ADDITIONAL DRIVING AID FUNCTIONS

or

– performs corrective action on the steering system.

3  You can retake control of the vehicle at any time by operating the steering wheel.

Location of the camera **1**

Make sure the windscreen is not obscured (by dirt, mud, snow, condensation etc.).



This function is an additional driving aid. This function is not under any circumstances intended to replace the due care and attention of the driver, who should at all times be in control of the vehicle.

Activation/deactivation

 Depending on the vehicle, according to the length of time following the last time the engine was stopped, the function is reactivated:

- when the vehicle is unlocked;
- or
- when a door is opened;
- or
- when the engine is restarted.

Activating, deactivating the system from the multimedia screen **2**



Please refer to the multimedia instructions for further information.

Activating, deactivating the system using the switch **3 My Safety**

ADDITIONAL DRIVING AID FUNCTIONS



The function can be deactivated or activated using the "Perso" mode of the "My Safety" function → 200. If the function has previously been deactivated from "Perso" mode:

– **To deactivate the function**, if it has previously been deactivated from the "Perso" mode of the "My Safety" function → 200, press twice on the switch

3. The warning light  is displayed in yellow or, depending on the vehicle, in white on the instrument

panel, or the warning light  disappears from the instrument panel.

– **To reactivate the function**, press the **3** switch once. Warning light  comes on the instrument panel.

Activating, deactivating the system from the trip computer (depending on the vehicle)





– **With the vehicle stationary**, press the switch **4** as many times as re-

quired to reach the  tab; or

– press control **4** and repeatedly press control **5** or **6** to reach the  tab;
– press switch **7** "OK";

– repeatedly press control **5** or **6** to reach the  menu, then press the switch **7** "OK";
– repeatedly press control **5** or **6** to reach the "DRIVING ASSIST" menu, then press switch **7** "OK";
– repeatedly press control **5** or **6** to reach the "Lane keeping" menu, then press switch **7** "OK";
– press switch **7** "OK" again to activate or deactivate the function:

-  function activated;
-  function deactivated.

When the function is deactivated, depending on the vehicle, the warning

light  is displayed in yellow or, depending on the vehicle, in white on the instrument panel, or the warning light

 disappears from the instrument panel.

ADDITIONAL DRIVING AID FUNCTIONS

Operation



When the function is activated, the

 warning light and the left-hand and right-hand line indicators **8** are displayed in grey on the instrument panel.

The function is set to operate when the vehicle speed is between approximately 40 mph (65 km/h) and 106 mph

(170 km/h)  and the left-hand or right-hand line indicators **8** appear in white on the instrument panel.

The function is in operation if the vehicle:

- approaches a roadside without activating the direction indicators;

- crosses a continuous line without activating the direction indicators;
- crosses a broken line without activating the direction indicators, if the "Operation on broken line" setting is selected.

In these cases:

- the function triggers an action on the vehicle's steering system to correct the vehicle trajectory;

and

- the warning light  flashes white or, depending on the vehicle, the warn-

ing light  is displayed in yellow and the indicator **8** on the side of the breached line is displayed in yellow on the instrument panel.

If corrective action taken on the steering system is not sufficient, the warn-

ing light  will continue to flash white or, depending on the vehicle, the

warning light  is displayed in red and the indicator **8** on the side of the breached line turns to red on the instrument panel. This is accompanied by a vibration on the steering wheel.

If the "Dashed line intervention" setting is not selected, **the function sounds the alarm** if the vehicle crosses a bro-

ken line without activating the indicator lights and there is no roadside close enough to the line.

In this case, the function warns the driver:

- by a vibration in the steering wheel; and

- the warning light  flashes white or, depending on the vehicle, the warn-

ing light  is displayed in red and the indicator **8** on the side of the breached line turns red on the instrument panel.

Note: on bends, the function allows for slightly cutting the bend.

Special case

"Keep control" warning

- If the system is in operation and does not detect any activity on the steering wheel, the "Keep control" message appears on the instrument panel accompanied by a beep and, de-

pending on the vehicle, the  warning light appears in red until the driver has regained control of the vehicle.

- If the system has been in operation for too long, the "Keep control" message appears on the instrument panel

ADDITIONAL DRIVING AID FUNCTIONS

accompanied by a beep and, depending on the vehicle, the  warning light appears in red accompanied by the indicator **B** on the side of the line concerned until the driver has regained control of the vehicle.





You can interrupt the trajectory correction at any time by moving the steering wheel.

Function temporarily unavailable/disabled

The system is temporarily unavailable or disabled when:

- very fast lane departure;
- driving continuously on a line;
- approximately four seconds after changing lanes;
- tight bends;
- impaired visibility;
- one of the direction indicators is activated;
- activating the hazard warning lights;
- engaging reverse gear;
- strong acceleration;
- the lane width changes;
- operation of the anti-lock braking system;

- operation of the electronic stability control ESC;
- operation of the anti-lock braking system.

When the function is unavailable, the warning light  turns grey on the instrument panel, or, depending on the vehicle, the warning light  does not appear on the instrument panel and the left-hand and right-hand line indicators **B** turn grey on the instrument panel.

Automatic deactivation

The function is automatically deactivated when:

- the electronic stability control ESC is deactivated or malfunctions;
- the anti-lock braking system is malfunctioning;
- A towbar is electrically connected to the trailer hitch socket;
- the  warning light is displayed.

When the function is deactivated, depending on the vehicle, the warning light  is displayed in yellow or, depending on the vehicle, in white on the instrument panel, or the warning light



disappears from the instrument panel.

Settings

Vehicle fitted with a multimedia screen 2



To access the multimedia screen function settings **2**, refer to the multimedia instructions:

– "Dashed line intervention": use this setting to select the function's response if the vehicle crosses a broken line without activating one of the direction indicators:

- selected setting: the function may trigger an action on the vehicle's

ADDITIONAL DRIVING AID FUNCTIONS

steering system to correct the vehicle trajectory;

- setting not selected: the function can warn the driver by means of a vibration at the steering wheel without correcting the vehicle trajectory.

3 – "Vibration": adjust the "Lane departure prevention" function steering wheel vibration level;

- depending on the vehicle, "Lane exit anticipation" or "Warning": adjust the line detection sensitivity level. To do this, select:

- "Late": line detected on crossing;
- "Standard": line detected on approach;
- "Early": line detected nearby.

Please refer to the multimedia instructions for further information.

Vehicle not fitted with a multimedia screen

(depending on the vehicle)



- **With the vehicle stationary**, press the switch **4** as many times as re-

quired to reach the  tab;

or

- press control **4** and repeatedly press

control **5** or **6** to reach the  tab;

- press switch **7 "OK"**;

- repeatedly press control **5** or **6** to

reach the  menu, then press the switch **7 "OK"**;

- repeatedly press control **5** or **6** to reach the "DRIVING ASSIST" menu, then press switch **7 "OK"**;

- repeatedly press control **5** or **6** to reach the "Lane Keep Assist sensitivi-

ty" menu, then press the **7 "OK"** switch;

- repeatedly press control **5** or **6** to select the setting, then press on switch **7 "OK"**.

Operating faults

When the system detects an operating fault:

- the warning light  is displayed in grey on the instrument panel;

or

- the  warning light disappears from the instrument panel.

In some cases, they are accompanied by:

- the "Driving assist unavailable" message;

or

- the "Check Driving assist" or "Check Front camera" message.

Consult an approved Dealer.

ADDITIONAL DRIVING AID FUNCTIONS

Warnings



This function is an additional driving aid. This function is not under any circumstances intended to replace the due care and attention of the driver, who should at all times be in control of the vehicle.

System servicing/repairs

- In the event of an impact, the camera alignment may be changed, and its operation may consequently be affected. Deactivate the function and consult an authorised dealer.
- Any work in the area where the camera is located (repairs, replacements, windscreen modifications etc.) must be carried out by a qualified professional.

Only an authorised dealer is qualified to service the system.

In the event of system disturbance

Some conditions can disturb or damage the operation of the system, such as:

- windscreen obscured (by dirt, ice, snow, condensation etc.) ;
- a complex environment (tunnel etc.) ;
- poor weather conditions (snow, rain, hail, black ice etc.) ;
- poor visibility (night, fog etc.) ;
- the road markings are irregular or difficult to distinguish (e.g. partially erased, excessive spacing, distorted road surface) ;
- being dazzled (glaring sun, lights of vehicles travelling in the opposite direction etc.) ;
- the road is narrow, winding or undulating (tight bends etc.) ;
- closely following a vehicle travelling in the same lane.

In this case, the "Lane departure prevention" function may be activated incorrectly or not at all.

Risk of unwanted, incorrect correction or no correction of trajectory.

Deactivating the function

You must disable the function if:

- the area of the camera has been damaged (on the windscreen side or the interior rear-view mirror side);
- the road is slippery (snow, black ice, aquaplaning, gravel etc.) ;
- poor visibility (night, fog etc.) ;

ADDITIONAL DRIVING AID FUNCTIONS

- the windscreen is cracked or distorted (do not carry out windscreen repairs in this area; have it changed by an Authorised Dealer);
- the vehicle is towing a trailer or a caravan;
- the vehicle is entering an area with several surface markings (an area with road works etc.).

3

ADDITIONAL DRIVING AID FUNCTIONS

Blind spot warning

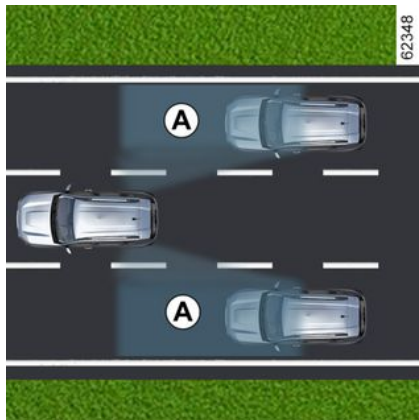

This system alerts the driver to other vehicles in the detection zone **A**.

The system is activated when the vehicle's speed is between approximately 19 mph (30 km/h) and 87 mph (140 km/h).



This function uses sensors **1** installed in the front and rear bumper of both sides.

Special feature

Make sure that the sensors are not obscured (by dirt, mud, snow, etc.).

If a sensor is obscured, the message "Blind spot clean sensor" is displayed on the instrument panel. Clean the sensors.



This function is an additional aid which indicates other vehicles in the blind spot area.

It can never in any case be a substitute for care nor for the driver's responsibility while in charge of his vehicle.

The driver should always be ready for sudden incidents while driving: always ensure that there are no moving obstacles (such as a child, animal, pushchair, bicycle, etc.) or small, narrow objects such as stones or posts in the blind spot when manoeuvring.

Activation/deactivation

Activating and deactivating the function from the multimedia screen **2**

ADDITIONAL DRIVING AID FUNCTIONS



To activate or deactivate the function, please refer to the multimedia instructions.

Select "ON" or "OFF".

Activating, deactivating the function using the 3 "My Safety" button



The function can be deactivated or activated using the "Perso" mode of the "My Safety" function → 200.

If the function has previously been deactivated from "Perso" mode:

- **to deactivate the alerts**, press the button 3 twice. The indicator light on the button 3 goes out;
- **to reactivate alerts**, press the button 3 once. The indicator light on the button 3 lights up.



The system's detection range operates according to a standard lane width. If you are driving in narrow traffic lanes, it may detect vehicles in other lanes.

Warning light 4

4

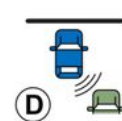
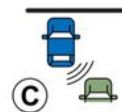

An indicator light 4 is situated on both rear view mirrors 5.

62258

ADDITIONAL DRIVING AID FUNCTIONS



Note: clean the door mirrors regularly **5** so that the warning lights **4** can be seen.

Operation

This function gives a warning:

- when the vehicle speed is between approximately 19 mph (30 km/h) and 87 mph (140 km/h);
- when another vehicle is in the blind spot area and travelling in the same direction as your vehicle.

If another vehicle is being overtaken, the indicator **4** will be activated only if that vehicle remains in the blind spot for more than one second.

Display *B*

The function is activated and has not detected any vehicles.

Display *C*

First warning: the warning light **4** signals that a vehicle has been detected in the blind spot area.

Display *D*

When the direction indicator is activated, the warning light **4** flashes when a vehicle is detected in the blind spot on the side towards which you are about to steer. If you cancel the direction indicator, the function will return to the initial warning (display *C*).



Because sensors have been installed in the bumpers, any work (repairs, replacements, touching up of paintwork) must be carried out by a qualified professional.

Conditions for non-function

- If the object is not moving;
- if traffic is heavy;
- if the road is winding;

– if front and rear sensors both detect an object at the same time (e.g. when passing an articulated lorry);

Operating faults

If the system detects a fault, the message “Check blind spot alert” is displayed on the instrument panel. Call an approved dealer.

Note: when the engine is started, the warning light **4**, display *B*, flashes four times. It is normal.

ADDITIONAL DRIVING AID FUNCTIONS

Warnings



- The system's detection range operates according to a standard lane width. If you are driving in wide traffic lanes, the system might not be able to detect a vehicle in the blind spot.
- In the event of very bad weather conditions (heavy rain, snow, etc.), the system may be temporarily disrupted.

Remain aware of driving conditions.

There is a risk of accidents.



This function is an additional driving aid. This function is not under any circumstances intended to replace the due care and attention of the driver, who should at all times be in control of the vehicle.

The driver should always adapt their speed to the traffic conditions, regardless of the system indications.

The system should under no circumstances be taken to be an obstacle detector or an anti-collision system.

System servicing/repairs

- In the event of an impact, radar alignment may be changed, and its operation will consequently be affected. Deactivate the function and consult an authorised dealer.
- Any work in the area where the radars are located (repairs, replacements, etc.) must be carried out by a qualified professional.

Only an authorised dealer is qualified to service the system.

System disturbance

Some conditions can disturb or damage the system's operation, such as:

- complex surroundings (metal bridges, tunnels, roads with barriers at the edge, etc.);
- poor weather conditions (snow, hail, black ice, etc.).

Risk of false alarms or absence of warnings

In the event of the system behaving abnormally, deactivate it and contact an authorised dealer.

ADDITIONAL DRIVING AID FUNCTIONS



Limitation of the system operation

- The radar area should be kept clean and free of any modifications in order to ensure the proper operation of the system.
- Small objects moving close to the vehicle (motorcycles, bicycles, pedestrians, etc.) may not be recognised by the system.
- When the vehicle enters corners and curves, detectors may temporarily no longer detect vehicles in adjacent lanes.
- The system may not react when the difference in speed with other vehicles is more than 19 mph (30 km/h).
- If the vehicle is being overtaken by a long vehicle (e.g. heavy goods vehicle overtaking at a similar speed to the vehicle) the system may interrupt the warning before the end of the manoeuvre.
- The vehicle is travelling on a winding road.

Deactivating the function

You must deactivate the function if:

- the radar area has been damaged (rear bumper);
- the vehicle is fitted with a towbar.

ADDITIONAL DRIVING AID FUNCTIONS

Safe distance alert



Using the information from the camera **1**, this function informs the driver of the time interval between their vehicle and the vehicle in front so that a safe stopping distance between the two vehicles can be maintained.

The function is activated when the vehicle speed is between about 19 and 93 mph or 99 mph (30 and 150 or 160 km/h), depending on the vehicle.

Location of camera 1

Make sure the windscreen is not obscured (by dirt, mud, snow, condensation etc.).



This function is an additional driving aid. This function is not under any circumstances intended to replace the due care and attention of the driver, who should at all times be in control of the vehicle.

Activating/deactivating the function

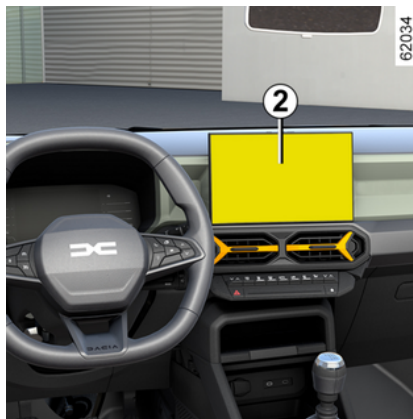

Vehicles fitted with a multimedia screen 2

From the "VEHICLE" world on your multimedia screen **2**, press the "Driving assistance" menu.

Activate or deactivate the "Following distance" function.



Vehicles not fitted with a multimedia screen

(depending on the vehicle)



– **With the vehicle stationary**, press the switch **3** as many times as re-

quired to reach the  tab;
or

– press control **3** and repeatedly press control **4** or **5** to reach the

 tab;
– press switch **6** "OK";

ADDITIONAL DRIVING AID FUNCTIONS

- repeatedly press control **4** or **5** to reach the  menu, then press the **6** "OK" switch;
- repeatedly press control **4** or **5** to reach the "DRIVING ASSIST" menu, then press switch **6** "OK";
- repeatedly press control **5** or **6** to reach the "Distance warning" menu, then press switch **6** "OK";
- press switch **6** "OK" again to activate or deactivate the function:
 -  function activated;
 -  function deactivated.



Each time the vehicle is started, the function continues the mode saved the last time the engine was stopped.

Operation

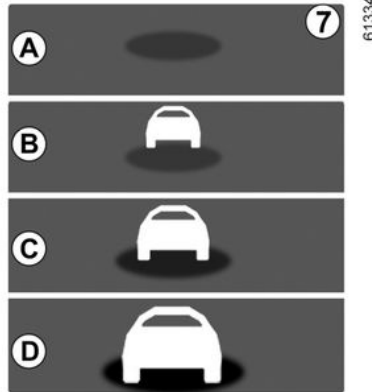

With the function activated, the **7** indicator is displayed on the instrument panel and informs the driver of the distance between their vehicle and the vehicle in front.

- **A** (grey): function not operational;
- **A** (green): no vehicle detected;
- **B** (green): the time interval is greater than or equal to around two seconds (distance between the two vehicles adapted to your speed);
- **C** (yellow): the time interval is between approximately one and two seconds (insufficient distance between the two vehicles);
- **D** (red): the time interval is less than or equal to around one second

(very insufficient distance between the two vehicles).

If the interval between the two vehicles is less than around 0.5 seconds, notification **7**, display **D**, will remain lit red on the instrument panel.

Under certain conditions, the time interval may not be displayed:

- while cornering;
- when changing lane;
- if the vehicle in front is sufficiently far or outside the range of the camera.

ADDITIONAL DRIVING AID FUNCTIONS

Warnings



The measurement is displayed for information: the system does not carry out any action on the vehicle. This function is not designed for use in urban conditions or for a dynamic driving style (sudden cornering, acceleration, braking, etc.), but rather for stable driving conditions.

The function does not interact with the braking system.

the camera should be kept clean and free of any modifications in order to ensure the proper operation of the system.

Any work in the area where the camera is located (repairs, replacements, windscreen modifications etc.) must be carried out by a qualified professional.

ADDITIONAL DRIVING AID FUNCTIONS



This function is an additional driving aid. This function is not under any circumstances intended to replace the due care and attention of the driver, who should at all times be in control of the vehicle.

System servicing/repairs

- In the event of an impact, the camera alignment may be changed, and its operation may consequently be affected. Deactivate the function and consult an authorised dealer.
- Any work in the area where the camera is located (repairs, replacements, windscreen modifications etc.) must be carried out by a qualified professional.

Only an authorised dealer is qualified to service the system.

In the event of system disturbance

- windscreen obscured (by dirt, ice, snow, condensation etc.);
- a complex environment (metal bridge, tunnel, etc.);
- poor weather conditions (snow, hail, black ice, etc.);
- poor visibility (night, fog, etc.);
- poor contrast between the vehicle preceding it and the surrounding area (e.g. white vehicle in a snowy area, etc.);
- being dazzled (glaring sun, lights of vehicles travelling in the opposite direction; etc.);
- the road is narrow, winding and undulating (tight bends etc.)

Risk of erroneous false alarms.

ADDITIONAL DRIVING AID FUNCTIONS

Active emergency braking



The system uses information from the camera **1**, to determine the distance from your vehicle:

– from the vehicle ahead in the same lane;

or

– from any oncoming vehicles in the context of a manoeuvre to change direction;

or

– and vehicles passing perpendicularly;

or

– and stationary vehicles;

or

– surrounding pedestrians and cyclists.

The system informs the driver if there is a risk of head-on collision to enable appropriate emergency manoeuvres (pressing the brake pedal and/or turning the steering wheel).

Depending on the reactivity of the driver, the system can assist with braking in order to limit damage or prevent a collision.

The system is otherwise inactive and does not trigger an alert.



This function is an additional driving aid.

This function is not under any circumstances intended to replace the due care and attention of the driver, who should at all times be in control of the vehicle.



This system can apply maximum braking to the vehicle until it is completely stationary if necessary.

For safety reasons, always wear your seat belt when travelling in your vehicle and make sure that it is loaded so that no items can be thrown forward and hit the occupants.

Location of the camera **1**

Make sure the windscreen is not obscured (by dirt, mud, snow, condensation etc.).

Operation

When driving, when there is a risk of collision, the system:

– **alerts you of a collision risk:** the "Detected obstacle" message appears on the instrument panel accompanied by a beep.

Note: if the driver presses the brake pedal and the system still detects a risk of collision, the braking force may be increased if it is not sufficient to prevent the collision.

– **braking may be triggered:** if the driver does not react to the alert and

ADDITIONAL DRIVING AID FUNCTIONS

the collision becomes imminent, the

red  warning light and the "Brake" message are displayed on the instrument panel accompanied by a beep.

Note:

- if the driver uses the vehicle controls (steering wheel, pedals, etc.) the system may delay its reaction or not activate;
- if active emergency braking has caused the vehicle to stop, the vehicle is kept stationary for a short time. Beyond this time limit, the driver must keep the vehicle stationary by holding their foot on the brake pedal;
- after the system activates braking, the message "Advanced Safety triggered" will be displayed.



In the event of emergency manoeuvre, you can stop braking at any moment by:

- tapping the accelerator pedal;
- or
- turning the steering wheel as a collision avoidance manoeuvre.



Special features of warnings

Depending on the speed, the warning and braking may be activated simultaneously.

Vehicle detection

Detection of vehicles travelling in the same lane

The risk of a collision with the vehicle in front of you in the same lane is detected by the system when:

- your vehicle is travelling at a speed between approximately 5 mph (8 km/h) and 112 mph (180 km/h).

Detection of oncoming vehicles in the context of a manoeuvre to change direction

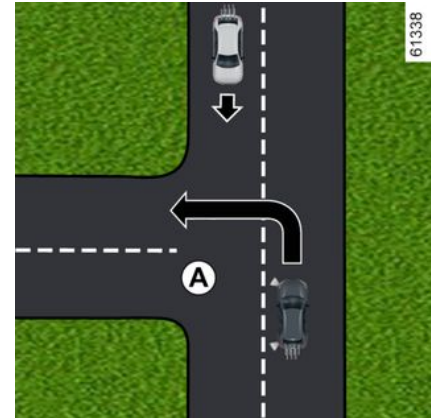

When you wish to change direction (e.g. **A**), oncoming vehicles are detected by the system when:

- your vehicle is travelling at a speed between approximately 5 mph (8 km/h) to 12 mph (20 km/h);
- you have activated the direction indicator light.

Detection of vehicles crossing the lane perpendicularly

Vehicles crossing the lane perpendicularly are detected by the system when:

- your vehicle is travelling at a speed between approximately 12 mph (20 km/h) and 37 mph (60 km/h).

Detection of vehicles stopped in the lane

ADDITIONAL DRIVING AID FUNCTIONS

Stationary vehicles are detected by the system when:

- your vehicle is travelling at a speed between approximately 5 mph (8 km/h) and 50 mph (80 km/h).

3 Detection of pedestrians and cyclists

Detection of pedestrians and cyclists in the same lane

The system detects pedestrians and cyclists when:

- your vehicle is travelling at a speed between approximately 5 mph (8 km/h) and 53 mph (85 km/h).

Detection of pedestrians and cyclists when changing direction

The system detects pedestrians and cyclists when:

- your vehicle is travelling at a speed between approximately 5 mph (8 km/h) to 12 mph (20 km/h);

Activation/deactivation

 Depending on the vehicle, according to the length of time following the last time the engine was stopped, the function is reactivated:

- when the vehicle is unlocked;
or
- when a door is opened;
or
- when the engine is restarted.

Activating, deactivating the system from the multimedia screen 2



To activate or deactivate the function, please refer- to the multimedia instructions.

Select "ON" or "OFF".

Activating, deactivating the system from the trip computer

(depending on the vehicle)

ADDITIONAL DRIVING AID FUNCTIONS



– **With the vehicle stationary**, press the switch **3** as many times as re-

quired to reach the  tab;

or

– press control **3** and repeatedly press

control **4** or **5** to reach the  tab;

– press switch **6 "OK"**;

– repeatedly press control **4** or **5** to

reach the  menu, then press the **6 "OK"** switch;

– repeatedly press control **4** or **5** to reach the "DRIVING ASSIST" menu, then press switch **6 "OK"**;

– repeatedly press control **4** or **5** to reach the "Active braking" menu, then press switch **6 "OK"**;

– press switch **6 "OK"** again to activate or deactivate the function:

–  function activated;

–  function deactivated.

Upon deactivation of the system, the

 warning light comes on or, de-

pending on the vehicle, the  warning light comes on in yellow on the instrument panel.

When the system is activated, the warning light disappears.

Settings



For safety reasons, carry out any adjustments while the vehicle is stationary.

Adjusting settings from the multimedia screen 2

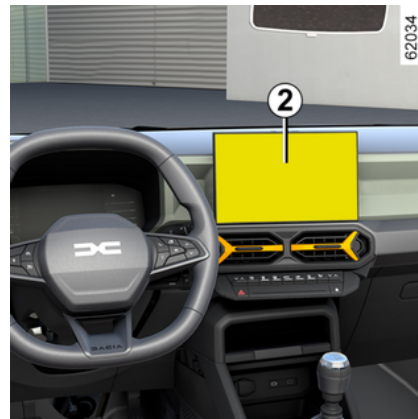

With the vehicle stationary, to access the function settings from the multimedia screen **2**, refer to the multimedia instructions:

– "Alert": adjust the sensitivity level. To do this select:

- « Late » ;
- « Standard » ;
- « Early ».

Please refer to the multimedia instructions for further information.

ADDITIONAL DRIVING AID FUNCTIONS



Vehicle not fitted with a multimedia screen

(depending on the vehicle)

– **With the vehicle stationary**, press the switch **3** as many times as re-

quired to reach the  tab;

or

– press control **3** and repeatedly press

control **4** or **5** to reach the  tab;

– press switch **6** "OK";

– repeatedly press control **4** or **5** to

reach the  menu, then press the **6** "OK" switch;

- repeatedly press control **4** or **5** to reach the "DRIVING ASSIST" menu, then press switch **6** "OK";
- repeatedly press control **4** or **5** to reach the "Active braking sensitivity" menu, then press switch **6** "OK";
- repeatedly press control **4** or **5** to select the setting, then press on switch **6** "OK".

Temporarily not available

If the system detects a temporary fault

the  warning light comes on, or

depending on the vehicle the  warning light comes on in yellow on the instrument panel.

The possible causes are:

- the system is temporarily blinded (glare from the sun, dipped beam headlights, bad weather conditions etc.). The system will be operational again when visibility conditions are better;
- the system is temporarily disrupted (for example: the windscreen is obscured by dirt, mud, snow, condensation, etc.). In this case, park the vehicle and switch off the engine. Clean the windscreen. The next time the engine is started, after five or ten minutes of driving, the warning light and the message disappear. If this is not the case,

this may arise from another cause; contact an Approved Dealer.

Operating faults

When the function detects an operat-

ing fault, the  warning light or,

depending on the vehicle, the  warning light comes on in yellow on the instrument panel.

Consult an approved dealer.

ADDITIONAL DRIVING AID FUNCTIONS

Warnings



This function is an additional driving aid. This function is not under any circumstances intended to replace the due care and attention of the driver, who should at all times be in control of the vehicle.

The triggering of this function may be delayed or prevented when the system detects clear signs of control of the vehicle by the driver (action on the steering wheel, pedals etc.).

The system cannot be activated when:

- the electronic stability control (ESC) has been triggered.

System servicing/repairs

– In the event of an impact, the camera alignment may be changed, and its operation may consequently be affected. Deactivate the function and consult an authorised dealer.

– Any work in the area where the camera is located (repairs, replacements, windscreen modifications etc.) must be carried out by a qualified professional.

Only an authorised dealer is qualified to service the system.

ADDITIONAL DRIVING AID FUNCTIONS



System disturbance

Some conditions can disturb or damage the operation of the system, such as:

- poor weather conditions (snow, rain, hail, black ice etc.) ;
- poor visibility (night, fog etc.) ;
- poor contrast between the object (vehicle, pedestrian etc.) and the surrounding area (e.g. pedestrian dressed in white located in a snowy area etc.) ;
- being dazzled (glaring sun, lights of vehicles travelling in the opposite direction etc.) ;
- windscreen obscured (by dirt, ice, snow, condensation etc.) ;
- ...

In these conditions, the system may not react, may warn the driver or may brake inadvertently.

Limitation of the system operation

- Each time the vehicle is started, the system carries out a calibration according to the vehicle surroundings and may be inactive for a length of time between approximately two to five minutes of driving;
- an oncoming vehicle will not trigger any warning or system action if the conditions detailed in the paragraph on "Special features of oncoming vehicles when changing direction" are not met;
- The camera should be kept clean and free of any modifications in order to ensure the proper operation of the system;
- the system may not respond to small vehicles as effectively as to other vehicles;
- the system may not operate properly when the road surface is slippery (rain, snow, black ice, etc.) ;
- to ensure correct operation, the system needs to distinguish the entire obstacle. So the system cannot detect:
 - pedestrians/cyclists in the darkness or in poor lighting conditions;
 - partially visible pedestrians/cyclists;
 - pedestrians less than approximately 80 cm;
 - pedestrians carrying large objects;
 - ...

In these conditions, the system may not react, may warn the driver or may brake inadvertently.

ADDITIONAL DRIVING AID FUNCTIONS



Deactivating the function

You must deactivate the function if:

- the camera area has been damaged (e.g. on the inside or outside of the windscreen);
- the vehicle is being towed (breakdowns);
- the windscreen is cracked or distorted (do not carry out windscreen repairs in this area; have it changed by an approved dealer);
- you are not driving on a paved road.

In the event of the system behaving abnormally, deactivate it and contact an authorised dealer.

Halting the function

You can halt the active braking function at any time by tapping the accelerator pedal or by turning the steering wheel in a collision avoidance manoeuvre.

ADDITIONAL DRIVING AID FUNCTIONS

Driver vigilance warning

The driver vigilance warning is a function that analyses the behaviour of the driver (driving style, vehicle steering, etc.) and alerts them if there is a risk of falling asleep.

It takes into account indicators such as:

- steering wheel movements;
- driver actions on other systems (indicators, brake pedal, etc.).



This function is an additional driving aid in case of risk of fatigue. The function does not operate on the vehicle. The function cannot, under any circumstances, replace the driver's responsibility during driving.

The driver must always adapt their driving according to their alertness, regardless of the system's indications.

Operation



The function is set to notify the driver if:

- a few minutes have elapsed since the vehicle last stopped;
- the vehicle speed is greater than approximately 43 mph (70 km/h).

If there is a risk of fatigue or impaired attention, the "Vigilance alert Have a break" message **1** is displayed on the instrument panel, accompanied by a beep.

Press switch **2** "OK" to delete the warning. It is advisable to stop as soon as possible for a break.

After deleting the message, the system continues vigilance monitoring and issues a new warning if necessary.



The driver vigilance warning constantly monitors the driver's attention and can provide several warnings per journey.

The system resets every time the engine is started.

Warning activation/deactivation



For safety reasons, carry out any adjustments while the vehicle is stationary.

ADDITIONAL DRIVING AID FUNCTIONS

- i** Depending on the vehicle, depending on the length of time following the last time the engine was stopped, the alerts are reactivated:
- when the vehicle is unlocked;
 - or
 - when a door is opened;
 - or
 - when the engine is restarted.

- i** When the alerts are deactivated, the system continues to assess the driver's state of fatigue.

Activating, deactivating alerts using the 3 "My Safety" button



The alerts can be deactivated or activated using "Perso" mode in the "My Safety" function → 200.

If the alerts have previously been deactivated using "Perso" mode:

- **to deactivate the alerts**, press the button **3** twice. The indicator light on the button **3** goes out;
- **to reactivate alerts**, press the button **3** once. The indicator light on the button **3** lights up.

Activating and deactivating the alerts from the multimedia screen **4**



To activate or deactivate the alerts, please refer to the multimedia instructions.



Choose **"ON"** or **"OFF"**.

Activating, deactivating the alerts from the trip computer **5**

(depending on the vehicle)

ADDITIONAL DRIVING AID FUNCTIONS



- **With the vehicle stationary**, press switch **6** as many times as required to reach the  tab;
- or
- press switch **6** and repeatedly press control **7** or **8** to reach the  menu;
- press switch **9 "OK"**;
- repeatedly press control **7** or **8** to reach the  menu, then press the switch **9 "OK"**;
- repeatedly press control **7** or **8** to reach the "DRIVING ASSIST" menu, then press switch **9 "OK"**;

- repeatedly press control **7** or **8** to reach the "Vigilance warning" menu, then press switch **9 "OK"**;
- press the **9 "OK"** switch again to activate or deactivate the alerts:

- warnings enabled;
- warnings deactivated.

Limitations of system operation

Some conditions can disrupt or damage the operation of the system, for example:

- certain driving styles (incorrect driving);
- driving on a road in poor condition;
- strong side wind;
- the clock is wrongly configured (depending on vehicle) → **115**;
- winding roads;
- trailer traction.

Operating faults

If the system detects a fault, the "Vigilance monit. to check" message and the  warning light are displayed on the instrument panel.

Have the system checked by an authorised dealer.

Detection of road signs



The system displays speed limits on the instrument panel according to road signs detected on the side of the road.

It mainly uses information taken from the camera **1** attached to the windshield behind the rear view mirror.

Depending on the country, the system also uses information from a map subscription to interpret certain signs (town entrance, etc.).

The sign displayed on the instrument panel changes when a road sign is detected by the system.

Once the speed limiter, the cruise control or, depending on the vehicle, the Stop and Go adaptive cruise control is

ADDITIONAL DRIVING AID FUNCTIONS

activated, you can adapt the limited speed setpoint to the speed displayed on the instrument panel by the system (→ 234 → 237 → 240).

If the detected speed limit is exceeded, the road sign displayed on the instrument panel is modified to inform the driver.

Location of the camera 1

Make sure the windscreen is not obscured (by dirt, mud, snow, condensation etc.).

Special features

For vehicles with a map subscription:

- if the vehicle is travelling in a country where the speed units differ from those of the vehicle, the system displays the speed limit sign in the unit of the country, alongside the speed limit converted to the unit used by the vehicle's instrument panel;
- for countries where the speed limit is reduced during rainy weather on some types of roads, the system may alter the detected speed limit after a few seconds of the windscreen wipers being activated.

For vehicles without a map subscription: when driving in a country where speed units differ from those on

your vehicle, you can manually select the speed unit shown on the instrument panel (e.g. change the unit from miles to kilometres) in order to display accurate information → 108.

Note: the system does not take into account exceptional speed limit measures, such as peak pollution days.

Operation

Warning lights

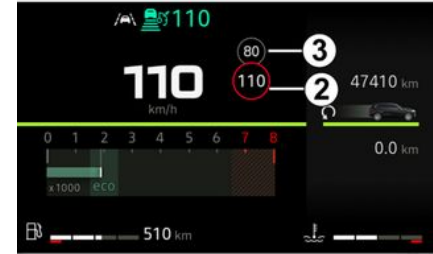

The function displays the following warning lights:

2. Speed limit signs and additional speed limit signs (speed on exit ramp with arrow, speed with a caravan, speed limit with length of application, etc.)

3. Additional road signs (start and end of no overtaking zone).

If the detected speed limit is exceeded, a circle flashes around the road sign (warning light 2) accompanied, depending on the vehicle, by a beep emitted for a few seconds to warn you. It remains illuminated on the instrument panel as long as the vehicle is exceeding the detected speed limit.

ADDITIONAL DRIVING AID FUNCTIONS

Map subscription

Road sign detection is associated with a map subscription.

Note: If there is no map for a country, a message will appear on the multimedia screen to inform and for downloading the map information relating to the country.

To manage the subscription, please refer to the multimedia instructions.

If there is no subscription, the system will be limited to taking into account the speed limit signs when they are detected by the camera.

The system will no longer take into account information related to the maps. The speed limit availability may be affected.

Activation/deactivation



For safety reasons, carry out any adjustments while the vehicle is stationary.

 Depending on the vehicle, depending on the length of time following the last time the engine was stopped, the sound alert is reactivated:

- when the vehicle is unlocked;
- or
- when a door is opened;
- or
- when the engine is restarted.

Activating, deactivating the over-speed sound alert using button 4 "My Safety"



The sound alerts can be activated or deactivated from the "Perso" mode in the "My Safety" function → 200.

If the sound alert has previously been deactivated using "Perso" mode:

- **to deactivate the sound alert**, press the button 4 twice. The indicator light on the button 4 goes out;
- **to reactivate the sound alert**, press the button 4 once. The indicator light on the button 4 lights up.

Activating, deactivating the over-speed sound alert from the multimedia screen 5

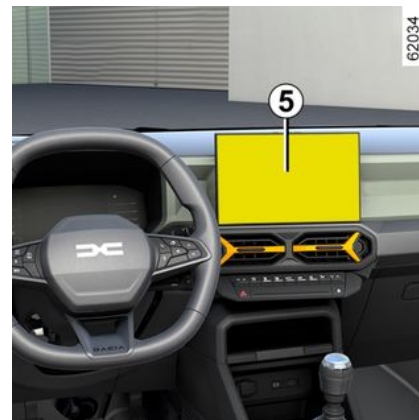

To activate or deactivate the sound alert, please refer to the multimedia instructions.

Choose "ON" or "OFF".

ADDITIONAL DRIVING AID FUNCTIONS

Activating, deactivating the over-speed sound alert from the trip computer

(depending on the vehicle)



– **With the vehicle stationary**, press switch **6** as many times as required to

reach the  tab;

or

– press switch **6** and repeatedly press

control **7** or **8** to reach the  menu;

– press switch **9** "OK";



– repeatedly press control **7** or **8** to

reach the  menu, then press the switch **9** "OK";

– repeatedly press control **7** or **8** to reach the "DRIVING ASSIST" menu, then press switch **9** "OK";

– repeatedly press control **7** or **8** to reach the "Speed alert" menu, then press switch **9** "OK";

– press switch **9** "OK" again to activate or deactivate the sound alert:

-  alert activated;
-  alert deactivated.

Variation of the limited speed or cruising speed



To adapt the speed limiter, cruise control or, depending on the vehicle, the Stop and Go adaptive cruise control

setpoint to the detected speed limit, press switch **10**.

Temporary unavailability

If the system is unavailable for reasons related to the camera or map data, the



symbol or, depending on the ve-

hicle, the yellow  symbol is displayed on the instrument panel. If there is still a problem, contact an approved dealer.

The system cannot detect the speed limit if:

- the windscreen is not clean;
- the camera is blinded by the sun;
- there is insufficient visibility (fog, etc.);
- the signs are not legible (snow, etc.) or are hidden (by another vehicle or by trees);
- map information is not up to date.

Note: when the front camera is obscured, the "Front camera no visibility" message appears on the instrument panel. Clean the windscreen area in front of the camera.

Operating faults

When the system detects an operating fault, the  or, depending on the

ADDITIONAL DRIVING AID FUNCTIONS

vehicle, the yellow  is displayed on the instrument panel.

In some cases, they are accompanied by the following message:

– « Driving assist unavailable » ;

or

– « Check Front camera » ;

or

– « Check Driving assist ». Consult an approved Dealer.

3

ADDITIONAL DRIVING AID FUNCTIONS

Warnings



This function is an additional driving aid. This function is not under any circumstances intended to replace the due care and attention of the driver, who should at all times be in control of the vehicle.

The driver must always adapt their speed to the highway code and traffic conditions, regardless of system indications.

The system may not detect all speed limit signs or may interpret them incorrectly.

The driver must not ignore road signs undetected by the system and should give priority to complying with the actual road signs and the highway code.

In the event of poor visibility (fog, snow, frost, etc.), it is possible that the system may not indicate the correct speed to the driver.

SPEED LIMITER

The speed limiter function controls the engine to help you not to exceed a driving speed that you have chosen, known as the **limit speed**.

The speed limiter function can be activated from 0 mph to 112 mph (180 km/h).



You can link the speed limiter to the "Road sign detection" function → **228**.

Controls



1 Switch to activate and increase the limit speed (**SET/+**).

2 Depending on the vehicle, road sign detection activation switch → **228**.

3 Switch for selecting/deselecting the driving aids, depending on the vehicle:

- cruise control;
- speed limiter;
- **OFF**.

4 Switch the function to standby, with limit speed stored (**0**).

5 Recall the stored cruising speed (**RES**).

6 Switch to activate and decrease the limit speed (**SET/-**).

When "**OFF**" mode is selected before the ignition is switched off, the "Speed limiter" function will be activated by default the next time the engine is started.

Driving

When a limit speed has been set but not yet reached, driving is similar to driving a vehicle without the speed limiter function.

Once you have reached the stored speed, no effort on the accelerator pedal will allow you to exceed the programmed speed except in an emergency (refer to information on "Exceeding the limit speed").

Switching on

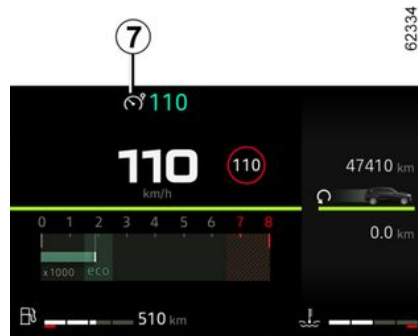

Press switch **3** until the light **7** lights up grey on the instrument panel. The "Speed limiter ON" message appears on the instrument panel accompanied by dashes to indicate that the speed limiter function is in operation and waiting to store a limit speed.

To store the current speed, press switch **1** (**SET/+**) or switch **6** (**SET/-**): the limit speed replaces the dashes and, depending on the vehicle, the indicator light **7** appears in white.

The minimum speed that can be stored is 19 mph (30 km/h).

SPEED LIMITER



Please note that you must keep your feet close to the pedals in order to react in an emergency.



The speed limiter function is in no way linked to the braking system.



If the speed limiter is not available (after several attempts to activate), contact an approved dealer.

Varying the limit speed



The limit speed may be changed by pressing repeatedly or holding down:

- switch **1** (**SET/+**) to increase the speed;
- switch **6** (**SET/-**) to decrease the speed.

Exceeding the limit speed

It is possible to exceed the limit speed at any moment. To do this, press the accelerator pedal **firmly down** beyond the point of resistance.

While the speed is being exceeded, the programmed speed displayed on the instrument panel flashes.

Then, release the accelerator pedal: the speed limiter function will return as soon as you reach a speed lower than the memorised speed.

Limited speed cannot be maintained

When driving down a steep gradient, the system is unable to maintain the limited speed: the stored speed will flash in red on the instrument panel and a beep sounds at regular intervals to inform you of this situation.

Putting the function on standby

The speed limiter function is suspended when you press switch **4** (**O**). The limit speed is stored and displayed in grey on the instrument panel.

Recalling the limit speed

If a speed has been stored, it can be recalled by pressing the switch **5**.



When the speed limiter is on standby, press switch **6** (**SET/-**) or switch **1** (**SET/+**) to reactivate the function without taking into account the stored speed: the vehicle's current speed will be taken into account instead.

SPEED LIMITER

Switching off the function



The speed limiter function is interrupted:

– when you press switch **3** until **OFF**, the "Driving assist. deactivated" message appears on the instrument panel. In this case, the speed is no longer stored;



In this case, the next time the engine is started, the "Speed limiter" function will be activated and waiting for a speed limit to be stored.

– you press the switch **3** until the light  appears on the display. In this case the cruise control is selected and there is no stored speed.

CRUISE CONTROL

The cruise control function controls the engine to help you to maintain a driving speed that you have chosen, known as the **cruising speed**.

The cruise control function can be activated from 19 mph (30 km/h) to 112 mph (180 km/h).



You can link the cruise control function to the "Road sign detection" function

→ 228.



The cruise control function is in no way linked to the braking system.

Controls



1 Switch to activate and increase the limit speed (**SET/+**).

2 Depending on the vehicle, road sign detection activation switch → 228.

3 Switch for selecting/deselecting the driving aids, depending on the vehicle:

- cruise control;
- speed limiter;
- **OFF**.

4 Switch the function to standby, with limit speed stored (**0**).

5 Recall the stored cruising speed (**RES**).

6 Switch to activate and decrease the limit speed (**SET/-**).

Switching on

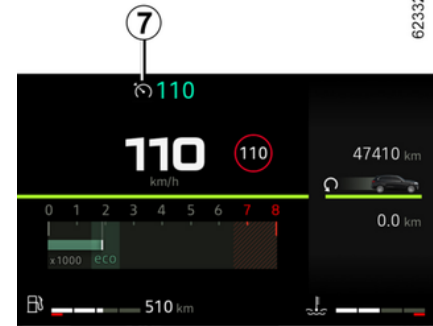

Press switch **3** until the light **7** lights up grey on the instrument panel.

The "Cruise control ON" message appears on the instrument panel accompanied by dashes to indicate that the cruise control function is activated and waiting to store a cruising speed.

CRUISE CONTROL

Activating cruise control



While the vehicle is moving at a steady speed above approximately 19 mph (30 km/h), press switch **6** (**SET/-**) or switch **1** (**SET/+**): the function is activated and the current speed is taken into account.

The cruising speed replaces the dashes. Cruise control is confirmed when the memorised speed and warning light appear in green **7**.

If you try to activate the function below 19 mph (30 km/h), the message "Invalid Speed" will be displayed and the function will remain inactive.

Driving

Once a cruising speed is registered and the cruise control function is active, you may lift your foot off the accelerator pedal.



Please note that you must keep your feet close to the pedals in order to react in an emergency.

Then, release the accelerator pedal: after a few seconds, the vehicle will automatically return to its set cruising speed.



If the cruise control is no longer available (after several attempts to activate it), contact an Approved Dealer.

Adjusting the cruising speed

The cruising speed may be changed by repeatedly pressing the:

- switch **6** (**SET/-**) to decrease the speed;
- switch **1** (**SET/+**) to increase the speed.

Note: press and hold one of the switches to modify speed by successive increments

Exceeding the cruising speed

The cruising speed may be exceeded at any time by depressing the accelerator pedal.

While it is being exceeded, the cruising speed flashes on the instrument panel.

Putting the function on standby



The function is set to standby if you:

- the switch **4** (**O**);
- the brake pedal;

CRUISE CONTROL

- the clutch pedal for a prolonged period or if the vehicle is in neutral for a prolonged period on vehicles equipped with a manual gearbox
- shifting to neutral position on vehicles equipped with an automatic gearbox.

The cruising speed is stored and displayed in grey on the instrument panel.

Returning to the cruising speed

If a speed is stored, it can be recalled, once you are sure that the road conditions are suitable (traffic, road surface, weather conditions, etc.). Press the switch **5 (RES)** if the vehicle speed is above 19 mph (30 km/h).

When the speed is stored, cruise control activation is confirmed in green on the instrument panel, the **7** warning light is displayed.

Note: if the speed previously stored is much higher than the current speed, the vehicle will accelerate more rapidly to reach this threshold.

With the cruise control on standby, press switch **6 (SET/-)** or switch **1 (SET/+)** to reactivate the cruise control function without taking into account the stored speed: it is the speed at which the vehicle is moving that is taken into account.

Switching off the function

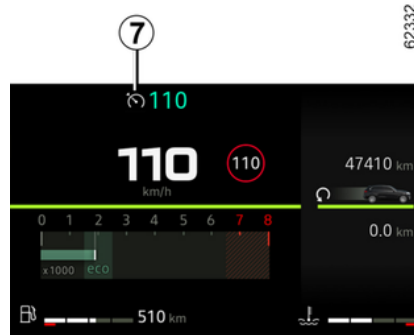

The cruise control function is interrupted:

- if you press switch **3** until the "Driving assist. deactivated" message appears on the instrument panel. In this case, there is no stored speed;
- you press the switch **3** until the light



appears on the display. In this case the speed limiter is selected and there is no stored speed.

The **7** warning light disappears from the instrument panel to confirm that the function has stopped.

STOP AND GO ADAPTIVE CRUISE CONTROL

Based on information from a camera, the Stop and Go adaptive cruise control function gives you the option of maintaining a selected speed, known as the cruising speed, while keeping a safe distance from the vehicle in front in the same lane.

Depending on the vehicle, when the "Road Sign Detection" function is activated → 228, the system can adapt the speed of your vehicle according to the speed limit signs recognized by the camera.

If the vehicle in front stops, the Stop and Go adaptive cruise control may brake your vehicle to a complete stop before setting off again.

The system controls acceleration and deceleration of your vehicle using the engine and braking system.

The system's maximum range is approximately 140 metres. This may vary according to the road conditions (ground relief, weather conditions, etc.)

The Stop and Go adaptive cruise control function can be activated from 0 km/h to 99 mph (0 to 160 km/h).

The function is indicated by the



Note:

- the driver must observe the maximum speed limit and safe distances according to the legislation in the country where they are driving;
- the Stop and Go adaptive cruise control can brake the vehicle up to a third of the braking capacity. Depending on the situation, the driver may need to brake harder.



The Stop and Go adaptive cruise control does not trigger an emergency stop and its braking capability is limited.



This function is an additional driving aid.

It can under no circumstances replace the

driver's responsibility to respect speed limits and safe distances or to be vigilant.

The driver must always be in control of the vehicle.

The driver must always adapt their speed according to the surroundings and traffic conditions.

Use the adaptive cruise control outside built-up areas, on wide roads with visible lines.

The cruise control may have limited operation on very winding or slippery roads (black ice, aquaplaning, gravel) or during bad weather (fog, rain, side winds, etc.)

There is a risk of accidents.

STOP AND GO ADAPTIVE CRUISE CONTROL

Location of the camera 1



Make sure the windscreen is not obscured (by dirt, mud, snow, condensation etc.).

Controls



2 Switch to activate and decrease the limit speed (**SET/-**).

3 Switch to activate and increase the limit speed (**SET/+**).

4 Depending on the vehicle, switch to activate the speed limit detection → **228**.

5 Put the function on standby (and store the cruising speed) (**0**).

6 Switch for selecting/deselecting the driving aids, depending on the vehicle:

- the Stop and Go  adaptive cruise control function;
- speed limiter;
- **OFF**.

7 Adjusting the following distance.

8 Recall the stored cruising speed (**RES**).

 Depending on the vehicle, you can link the cruise control function to the "Road sign detection" → **228** function by pressing button **4**.

3

Displays

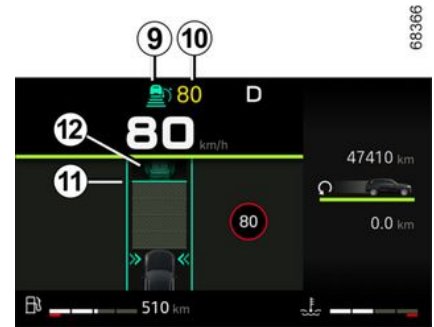

9. Adaptive cruise control warning light.

10. Stored cruising speed.

STOP AND GO ADAPTIVE CRUISE CONTROL

11. Stored safe distance

12. Vehicle in front.



The camera should be kept clean and free of any modifications in order to ensure the proper operation of the system.

Switching on

Press switch **6** as many times as required to select the adaptive cruise control Stop and Go.

The warning light **9**  appears in grey and the "Adaptive Cruise Ctl selected" message appears on the instrument panel accompanied by dashes to indicate that the function is activated and waiting to store a cruising speed.

This function cannot be activated when:

- the parking brake is applied;
- the Park Assist function is already activated → **252**.

The "Adaptive Cruise Ctl unavailable" message is displayed on the instrument panel.

Activating cruise control

With the vehicle stationary or moving at a steady speed, press switch **3** (SET/+) or **2** (SET/-) to activate the function and store the current speed.

The minimum cruising speed is 19 mph (30 km/h).

The cruising speed **10** replaces the dashes and the cruise control operation is confirmed by the appearance of the cruising speed in green and warn-

ing light **9** .

If you attempt to activate the function at a speed over 99 mph (160 km/h), the "Invalid Speed" message appears and the function remains deactivated.

Once a cruising speed is memorised and the cruise control function is active, you may lift your foot off the accelerator pedal.

Note: if your vehicle speed is lower than about 19 mph (30 km/h), the function uses a default cruising speed of 19 mph (30 km/h). The vehicle will accelerate until it reaches the stored cruising speed.



Important: you should keep your feet near the pedals at all times to prepare for any event.

Activating cruise control with speed limit sign recognition

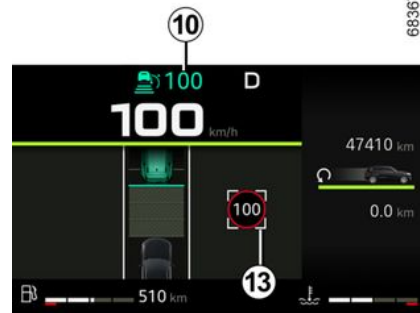

If the vehicle is equipped with the "Road sign detection" function → **228**, press switch **4** to adapt the vehicle's speed to the speed limits **13** detected by the camera.

When passing the sign, the cruising speed **10** adopts the value of the detected speed **13**.

68367

STOP AND GO ADAPTIVE CRUISE CONTROL

The driver must always stay vigilant regarding the speed applied by the system and remains responsible for the vehicle speed.

Safe distance control activation

As soon as cruise control is activated, the default safe distance **11** is displayed in green on the instrument panel.

The following distance setting is stored by the system between each activation of Adaptive Cruise Control and for the next vehicle start cycle.

If the system detects a vehicle in your lane, an outline of a vehicle **12** appears above the distance gauge **11** on the instrument panel.

Your vehicle adapts its speed to that of the vehicle in front and applies the brakes if necessary (the brake lights come on) in order to maintain the distance displayed on the instrument panel.

Note: the size of the **12** outline varies according to the distance separating you from the vehicle in front. The larger the outline, the closer the vehicle in front.

Setting the cruising speed

You can vary the speed by repeatedly pressing (small increments) or press-

ing and holding (large increments) switch **2** or **3**:

- switch (SET/-) **2** to reduce the speed;
- switch (SET/+) **3** to increase the speed.

Adjusting the following distance



You can vary the safe distance from the vehicle in front at any time by pressing switch **7** repeatedly.

The horizontal distance gauge on the instrument panel indicates the various available safe distances:

- distance gauge **A**: long distance (corresponding to approximately 2.4 seconds);

- distance gauge **B**: intermediate distance 2 (corresponding to approximately two seconds);
- distance gauge **C**: intermediate distance 1 (corresponding to approximately 1.6 seconds);
- distance gauge **D**: short distance (corresponding to approximately 1.2 seconds).

The selected distance gauge appears in green on the instrument panel.

The other gauges remain in grey.

Note: the distance must be set according to the traffic level, local regulation and weather conditions.



The following distance setting is stored by the system between each activation of Adaptive Cruise Control Stop and Go and for the next vehicle start cycle.

STOP AND GO ADAPTIVE CRUISE CONTROL

Exceeding the cruising speed

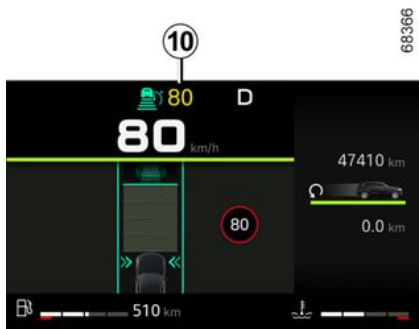

The cruising speed may be exceeded at any time by applying the accelerator pedal.

If it is exceeded, the cruising speed **10** appears in red.

The distance gauge flashes if the distance between your vehicle and the vehicle in front is less than the safe distance selected: the "Safe Distance Control" function is no longer active.

Then, release the accelerator pedal: the cruise control and safe distance control will automatically resume the speed and distance instructions that you had previously selected.

Overtaking manoeuvre

If you wish to overtake the vehicle in front of you, activating the direction indicator temporarily cancels the safe distance control and allows sufficient acceleration speed for overtaking.

Stop and start

If the vehicle in front slows down, the system adapts its speed to bring the vehicle to a complete stop if necessary (e.g. in heavy traffic). The vehicle stops a few metres from the vehicle in front. The Stop and Start function can put the engine on standby → **155**.

When the vehicle in front moves off again:

- if the stop does not exceed approximately thirty seconds, the vehicle sets off automatically without any action by the driver;

Note: the driver should always be ready for sudden incidents while driving and remains responsible for controlling the vehicle: if the system detects a pedestrian in the area around the vehicle, the automatic restart will be inhibited until the next stop;

- if the stop exceeds approximately thirty seconds, you must press the accelerator pedal or press switch **8** (**RES**) in order for the vehicle to set off again. The "Press RES or accelerate

to restart Cruise Control" message appears on the instrument panel to confirm this.

If the stop exceeds about three minutes, the electronic parking brake is automatically applied and the Stop and Go adaptive cruise control is deactivated.

The warning light **9**  goes out to confirm that the function is deactivated.

Putting the function on standby

You can set the function to standby when:

- you press switch **5** (**0**);
- you apply the brake pedal while the vehicle is moving.

The function is deactivated by the system if:

- you set the gearbox to **P**, **R** or **N** ;
- you unbuckle the driver's seat belt;
- you open one of the opening elements;
- you press the engine start/stop button;
- the slope is too steep;
- the vehicle speed is above 106 mph (170 km/h);
- certain driving aids and correction devices are triggered (active emergency braking, ABS, ESC.)

STOP AND GO ADAPTIVE CRUISE CONTROL

In all circumstances, the standby is confirmed when the warning lights appear in grey and the message "Adaptive Cruise Control disconnected" appears on the instrument panel.



Putting the Stop and Go adaptive cruise control in standby or switching it off does not cause a rapid reduction in speed: you must brake by applying the brake pedal if necessary.

Exit from standby

- The parking brake is applied.
- The "Active Emergency Braking" function triggers braking.
- The sensor is obstructed (camera blindness detected).

Based on the stored cruising speed

If a speed is stored, it can be recalled, once you are sure that the road conditions are suitable (traffic, road surface, weather conditions, etc.).

Press switch **8** (**RES**) within the valid speed range. When the stored speed is recalled, activation of the cruise control is confirmed by the illumination of the cruising speed in green.

Note: if the stored speed is higher than the current speed, the vehicle will accelerate to reach that speed.

Based on the current speed

With the cruise control function on standby, pressing switch **2** (**SET/-**) or **3** (**SET/+**) reactivates the cruise control function without taking into account the stored speed: it is the vehicle's current speed that is taken into account.

"Take control of the vehicle" warnings

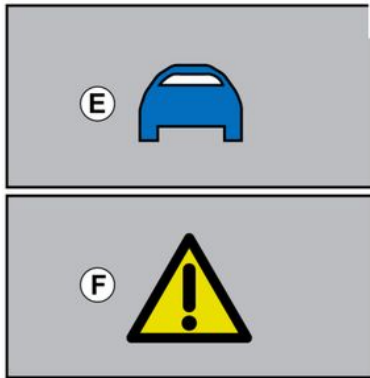

In some situations (e.g. coming up on a much slower vehicle, vehicle in front changing lanes quickly, etc.) the system may not have time to react.

Depending on the situation, the system sounds a beep associated with:

- the orange alert **E** if the situation requires the driver's attention;
- or
- the red alert **F** accompanied by the "Brake" message if the situation requires the driver's immediate attention.

In all situations, react accordingly and perform the appropriate manoeuvres.

Switching off the function

The "Stop and Go adaptive cruise control" function is interrupted when you press switch **6**.

The warning light **9**  disappears from the instrument panel to confirm that the function is no longer active.

Temporarily not available

The grey warning light **9**  disappears to confirm that the function has been automatically deactivated.

Ensure that the camera area has not been obscured (by dirt, mud, snow, etc.) or subject to an impact.

Conditions in certain geographical areas may hinder the function, for example:

STOP AND GO ADAPTIVE CRUISE CONTROL

- arid zones, tunnels, long bridges or lightly used roads without road lines, without signs or trees nearby;
- a military or airport zone.

You must leave such areas in order for the function to work.

In all cases, if the message is not erased after the engine is restarted, please contact an authorised dealer.

Operating faults

If an operating fault is detected for the "Stop and Go adaptive cruise control" function, the "Check Adaptive Cruise Control" message appears on the instrument panel and the "Stop and Go adaptive cruise control" function is interrupted.

If an operating fault is detected on one or more components of the system, the "Stop and Go adaptive cruise control" function is interrupted.

Depending on the type of malfunction, the message is displayed on the instrument panel:

- Check Front camera accompanied, depending on the vehicle, by the



warning light;

- Check vehicle accompanied, depending on the vehicle, by the



warning light;

- Check Camera/Radar.
Consult an approved Dealer.

Limitations of system operation

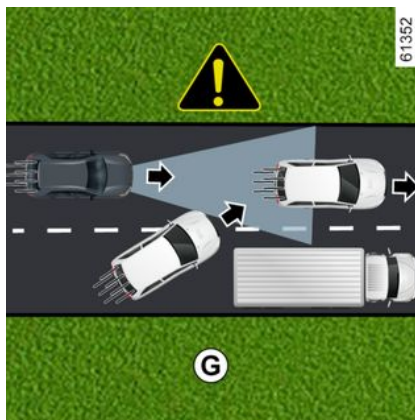

Vehicle detection

The system detects only vehicles (cars, trucks, motorbikes) that are moving in the same direction as your vehicle.

A vehicle moving into the same lane (example **G**) will be taken into account by the system only once it has completely entered the camera detection zones.

The system may trigger abrupt or delayed braking.



The system cannot detect:

- vehicles arriving at intersections: slip road (example **H**);
- vehicles driving on the wrong side of the road or reversing towards you.



The adaptive cruise control must only be used on a motorway (or multi-lane road separated by a barrier).

STOP AND GO ADAPTIVE CRUISE CONTROL

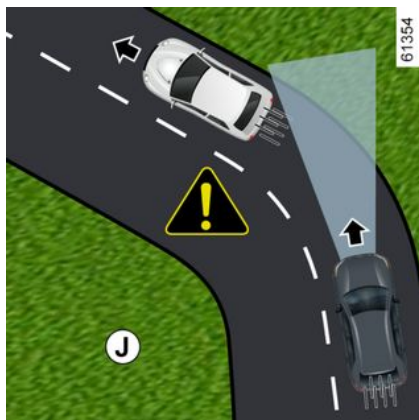

Detection during cornering

When entering a corner or bend, the camera may temporarily be unable to detect the vehicle in front (example **J**).

The system may trigger an acceleration.

When exiting a bend, the system's detection of the vehicle in front may be disrupted or delayed.

The system may trigger abrupt or delayed braking.

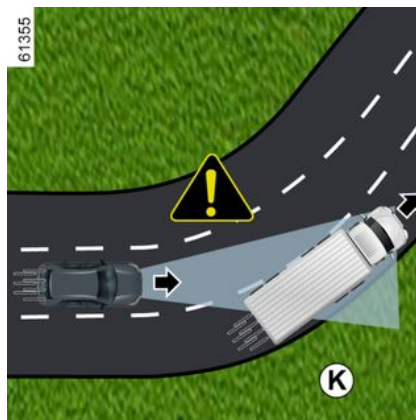

Detection of vehicles in adjacent lanes

The system may detect vehicles driving on an adjacent lane when:

- you drive into a bend (example **K**);
- you are driving on a road with narrow lanes;
- the speed of the vehicle on the adjacent lane is slower and if one of these vehicles is located too close to the lane of the other.

The system may incorrectly trigger vehicle slowing or braking.

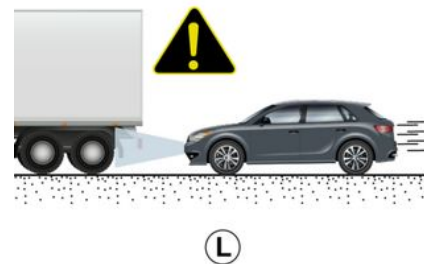

Vehicles hidden due to variations in ground relief

The system will not register vehicles driving uphill or downhill when hidden by terrain or when located outside the camera's detection zones.

Vehicles outside the camera detection zones

The system will react late or not at all if detected vehicles are outside the camera detection zones, particularly in the following situations:

STOP AND GO ADAPTIVE CRUISE CONTROL

3

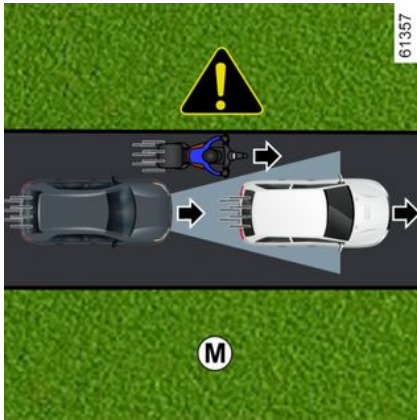

- vehicles transporting long objects which exceed the line;
- vehicles insufficiently centred in the lane;
- narrow vehicles which are very close (example **M**).

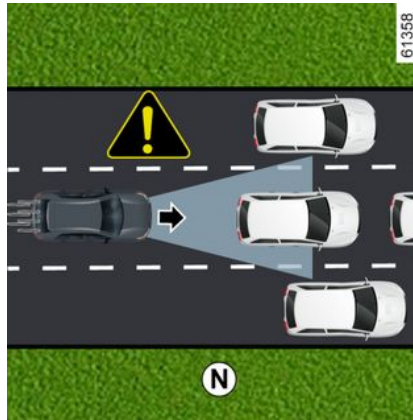

Stationary and slow moving vehicles

When your speed is over approximately 31 mph (50 km/h), **the system does not detect:**

- stationary vehicles (example **N**);
- very slow moving vehicles.

When your speed is less than approximately 31 mph (50 km/h), **the system may not react or may react very late to:**

- stationary vehicles (example **N**);
- very slow moving vehicles;

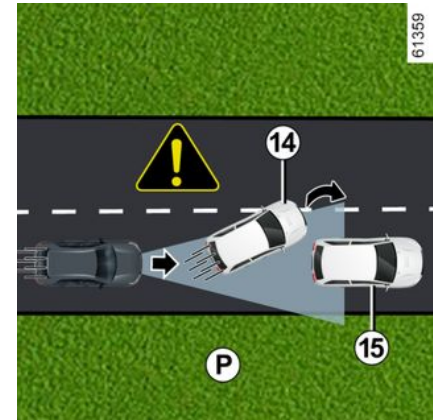

- preceding vehicles **14** that change lane or discovering a slow or stationary vehicle **15** (example **P**);
- stationary or slow vehicles **16**, when you change lane (example **Q**).

STOP AND GO ADAPTIVE CRUISE CONTROL

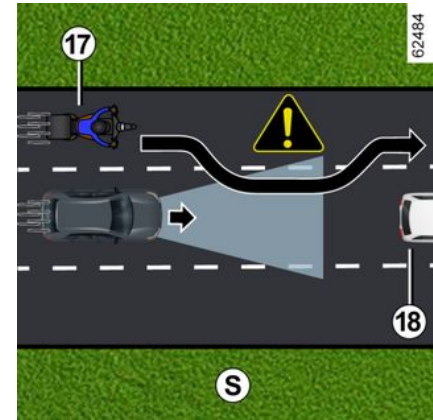
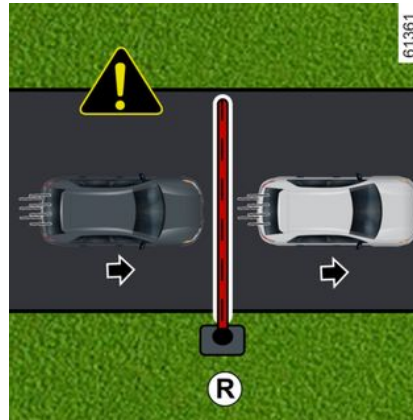
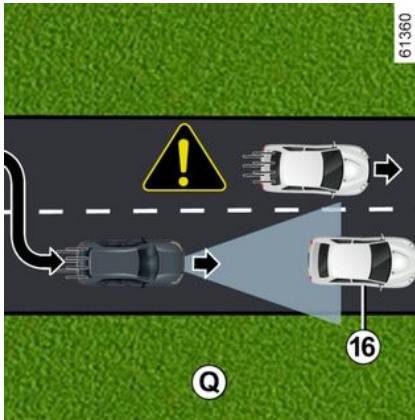

i Always be ready to take control of your vehicle when you come upon stationary or very slow-moving vehicles (example **N**).

The adaptive cruise control does not trigger an emergency stop and its braking capability is limited.

Non-detection of fixed obstacles and objects of a small size

The system cannot detect:

- pedestrians, bicycles, scooters, shopping trolleys, caddies, etc.;
- animals;
- fixed obstacles (toll barriers, walls, etc.) (example **R**).

These are not taken into account by the system.

They do not trigger any alert or reaction by the system.

Detection of vehicles moving into lane at high speed

If your vehicle is overtaken by another vehicle driving at high speed **17** (motorcycle, car, etc.) and the vehicle is temporarily between you and the vehicle in front **18**, **the system may trigger undue acceleration, slowing or braking.**

STOP AND GO ADAPTIVE CRUISE CONTROL

Warning



This function is an additional driving aid. It can under no circumstances replace the driver's responsibility to respect speed limits and safe distances or to be vigilant.

The driver must always be in control of the vehicle.

The driver must always adapt their speed to the surroundings and driving conditions, regardless of system indications. Except for lines delimiting lanes, traffic indicators (traffic lights, signs, pedestrian crossings etc.) are not recognised by the system. These do not trigger any alert or reaction by the system.

The system should under no circumstances be taken to be an obstacle detector or an anti-collision system.

The adaptive cruise control must only be used on a motorway (or multi-lane road separated by a barrier).

System servicing/repairs

- In the event of an impact, the camera alignment may be changed and its operation may consequently be affected. Deactivate the system and consult an authorised dealer.
- Any work in the area where the camera is located (repairs, replacements, windscreen modifications etc.) must be carried out by a qualified professional.

Only an authorised dealer is qualified to service the system.

Deactivating the function

You must deactivate the function if:

- the vehicle is travelling on a winding road;
- the vehicle is being towed (breakdowns);
- the vehicle is towing a trailer or a caravan;
- the vehicle arrives at a toll point, a roadwork area or on a narrow lane;
- the vehicle is being driven up or down a very steep slope;
- the visibility is poor (glaring sun, fog, etc.);
- the vehicle is being driven on a slippery road surface (rain, snow, gravel, etc.);
- the weather conditions are poor (rain, snow, side winds, etc.);
- the camera area has been damaged (e.g. on the inside or outside of the windscreen);
- the windscreen is cracked or distorted.

STOP AND GO ADAPTIVE CRUISE CONTROL

In the event of the system behaving abnormally, deactivate it and contact an authorised dealer.



In the event of system disturbance

Some conditions can disturb or damage the system's operation, such as:

- windscreen obscured (by dirt, ice, snow, etc.);
- poor weather conditions (snow, heavy rain, hail, black ice, etc.);
- poor visibility (night, fog, etc.);
- poor contrast between the vehicle preceding it and the surrounding area (e.g. white vehicle in a snowy area, etc.);
- being dazzled (glaring sun, lights of vehicles travelling in the opposite direction; etc.);
- narrow, winding or undulating road (tight bends, etc.);
- a slower vehicle with a significant difference in speed;
- use of mats not adapted to the vehicle. On the driver's side, only use mats suitable for the vehicle, attached with the pre-fitted components, and check the fitting regularly. Do not lay one mat on top of another. **There is a risk of wedging the pedals.**

In these cases, the system may wrongly intervene.

Risk of unwanted braking or acceleration.

Many unforeseen situations may affect the system operation. Certain objects or vehicles that appear in the camera detection zone may be interpreted by the system incorrectly, possibly leading to inappropriate acceleration or braking.

You should always be attentive to sudden events that might occur while you are driving. Always keep your vehicle under control by keeping your feet near the pedals, so that you are ready to act in any event.

PARKING AIDS

Parking distance control

Introduction

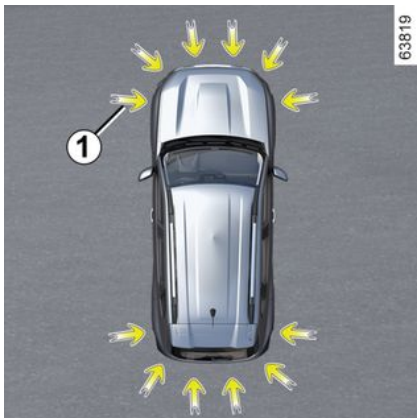

Ultrasonic sensors, indicated by arrows **1**, are fitted in the bumpers to detect obstacles near the vehicle.

The function alerts the driver via audible signals and a display representing the area where the obstacle was detected.

Depending on the equipment, the system detects obstacles behind, in front and to the sides of the vehicle.

The parking distance control system is only activated when the vehicle is driven at a speed below approximately 6 mph (10 km/h).

The function does not take into account towing or carrying systems that are not recognised by the system.



This function is an additional driving aid. Under no circumstances should it replace the driver's care or responsibility whilst reversing.

The driver should always be ready for sudden incidents while driving: always ensure that there are no small, narrow moving obstacles (such as a child, animal, pushchair, bicycle, stone, post, etc.) in the blind spot when manoeuvring.



An impact to the underside of the vehicle while manoeuvring (e.g. striking a post, raised kerb or other street furniture) may result in damage to the vehicle (e.g. deformation of an axle). To avoid any risk of accident, have your vehicle checked by an approved Dealer.

Location of the ultrasonic sensors **1**

Ensure that the area around the ultrasonic sensors indicated by the arrows **1** is not obscured (by dirt, mud, snow, a badly fitted/attached number plate), impacted, modified (including paintwork) or obstructed by any accessory fitted to the rear and/or, depending on the vehicle, to the front or sides of your vehicle.

PARKING AIDS

Operation

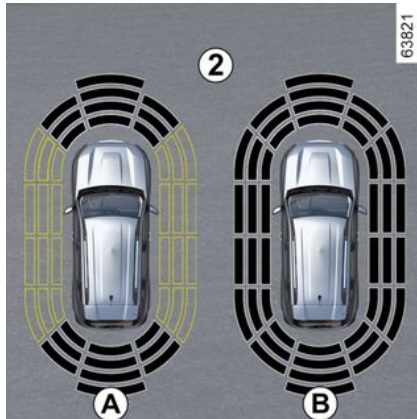

The screen **2** shows the vehicle surroundings, accompanied by beeps.

Depending on the equipment, it may be necessary to travel a few metres before the side detection is activated.

If all areas have a grey background, the whole area around the vehicle is being monitored:

- display **A**: analysis of vehicle surroundings in progress;
- display **B**: analysis of vehicle surroundings complete.

Obstacle detection

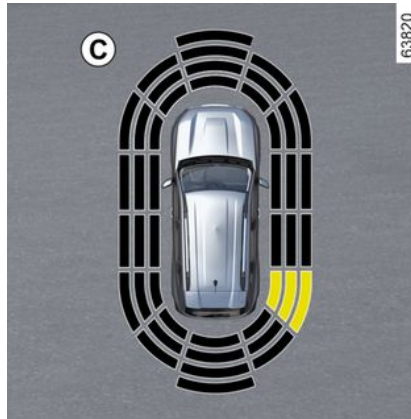

The system is able to detect most obstacles located near the rear and, depending on the equipment, near the front and sides of the vehicle.

The audible signal frequency will increase as the vehicle approaches on obstacle, until it becomes a solid beep at approximately 20 cm for an obstacle detected on the sides and approximately 30 cm for an obstacle detected to the front or rear.

The area where the obstacle has been detected is displayed (display **C**). Depending on the vehicle, the area is displayed in green, orange (or yellow depending on the vehicle) or red, depending on the proximity of the detected obstacle.

i In the event of a change in trajectory during a manoeuvre, the risk of collision with an obstacle may be signalled late.

3

Special case of obstacles detected on the side

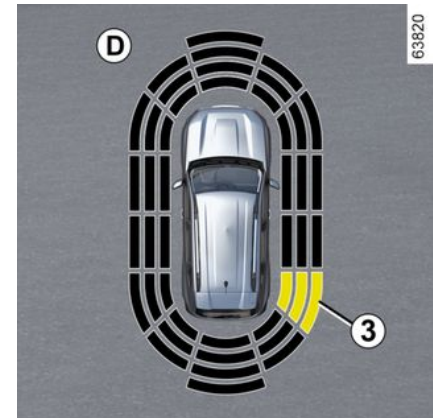

Depending on the direction of the wheels, the system determines the trajectory of the vehicle and notifies the driver if there is a risk or not of a collision with an obstacle **3** to the side of the vehicle.

If a side obstacle is detected:

- the beeps become faster and then sound continuously as the obstacle

PARKING AIDS

gets nearer. The area where the obstacle **3** has been detected is displayed (display **D**);

– if there is no risk of collision, no beep will sound when approaching the obstacle. Depending on the vehicle, the area where the obstacle **3** has been detected is shown interspersed.



In the event of a change in trajectory during a manoeuvre, the risk of collision with an obstacle may be signalled late.

Activation/deactivation

Vehicles fitted with a multimedia screen **4**



From the "VEHICLE" world on your multimedia screen **4**, press the "Parking assistance" menu.

Activate or deactivate areas covered by the ultrasonic detectors.

Please refer to the multimedia instructions for further information.

Note: depending on the vehicle, the "rear" detection zone cannot be deactivated.

Activating/deactivating the system from the trip computer **5**

(depending on the vehicle)



Vehicle stationary:

– **With the vehicle stationary**, press switch **6** as many times as required to

reach the  tab;

or

– press switch **6** and repeatedly press

control **7** or **8** to reach the  menu;

– press switch **9** "OK";

– repeatedly press control **7** or **8** to

reach the  menu, then press the switch **9** "OK";

– repeatedly press control **7** or **8** to reach the "DRIVING ASSIST" menu, then press switch **9** "OK";

PARKING AIDS

- repeatedly press control **7** or **8** to reach the "Parking" menu, then press switch **9 "OK"**;
- press switch **9 "OK"** again to activate or deactivate the function:

- function activated;
- function deactivated.

Note: depending on the vehicle, the rear detection zone cannot be deactivated.

Parking distance control automatic deactivation

The system is deactivated:

- when the vehicle speed is above approximately 6 mph (10 km/h);
- depending on the vehicle, when the vehicle is stationary for more than approximately five seconds and an obstacle is detected (such as when in a traffic jam, etc.);
- when you are in **N** or **P** position;
- when an operating fault is detected.

Note: depending on the vehicle, if the vehicle is fitted with a towbar recognised by the system, only the rear Park Assist function is deactivated.

Adjustment



For safety reasons, carry out any adjustments while the vehicle is stationary.



Each time the vehicle is started, the function resumes the activation status saved the last time the engine was stopped.

Adjusting settings from the multimedia screen **4**





With the vehicle stationary, from the "Vehicle" world on the your multimedia screen **4**, press the "Parking assistance" menu.

Please refer to the multimedia instructions for further information.

Settings from the trip computer **5**
(depending on the vehicle)

PARKING AIDS



- **With the vehicle stationary**, press switch **6** as many times as required to reach the  tab;
or
- press switch **6** and repeatedly press control **7** or **8** to reach the  menu;
– press switch **9 "OK"**;
– repeatedly press control **7** or **8** to reach the  menu, then press the switch **9 "OK"**;
– repeatedly press control **7** or **8** to reach the "DRIVING ASSIST" menu, then press switch **9 "OK"**;

- repeatedly press control **7** or **8** to reach the "Parking" menu, then press switch **9 "OK"** again;

Deactivating the system sound

(depending on the vehicle)

Activate or deactivate the parking distance control sound.

Note: if you mute the sound, when approaching an obstacle you will be alerted only by the display.

Parking distance control audio volume

Adjust the Park Assist volume using the volume bar.



Each time the vehicle is started, the function resumes the activation status saved the last time the engine was stopped.

Special cases

You can manually deactivate sound alerts or, depending on the vehicle, the detection zone concerned in the event that:

- towing, carrying or trailer equipment that is unrecognised by the system is present in front of the ultrasonic sensors;

- the ultrasonic sensors are damaged.

Note: if the sound is deactivated, the displays will continue to warn you erratically.

Operating faults

When the system detects a malfunction: either a sound signal warns you for about three seconds when the reverse gear is engaged, accompanied by the "Check Parking sensors" message on the instrument panel, or the system does not produce a sound or display when the reverse gear is engaged.

Check that your ultrasonic sensors are clean. If it the fault persists, consult an approved Dealer.



When the vehicle is travelling at a speed below approximately 6 mph (10 km/h), some noises (motorcycle, lorry, pneumatic drill, etc.) may trigger the Park Assist system audible warnings.

Guidelines



System servicing/repairs

- In the event of an impact, the alignment of the ultrasonic sensors may be altered and its operation may consequently be affected. Deactivate the function and consult an authorised dealer.
- Any work in the area where the ultrasonic sensors are located (repairs, replacements etc.) must be carried out by a qualified professional.

Only an authorised dealer is qualified to service the system.

System disturbance

Some conditions can disrupt or damage the system operation, for example:

- poor weather conditions (rain, snow, hail, black ice, etc.);
- some types of noise (motorcycle, lorry, pneumatic drill, etc.);
- fitting an non-compatible towing ball or hook.

Risk of false alarms or absence of warnings

If the system behaves abnormally contact an authorised dealer.

Limitation of the system operation

- The ultrasonic detection zones should be kept clean and free of any modifications in order to ensure the proper operation of the system.
- Small objects moving close to the vehicle (motorcycles, bicycles, pedestrians, etc.) may not be recognised by the system.
- The system may not detect obstacles that are too close to the vehicle.
- The system may not provide a warning when the other vehicles or obstacles are travelling at a significantly different speed.
- When there is a change in trajectory during a manoeuvre, the system may be slow in reporting obstacles

PARKING AIDS

Reversing camera

Operation



When reverse gear is engaged, the camera **1** located at the rear of the vehicle transmits a view of the area behind the vehicle to the multimedia display **2** accompanied by three guide lines **3**, **4** or **5** (fixed, moving and trailer guide lines).

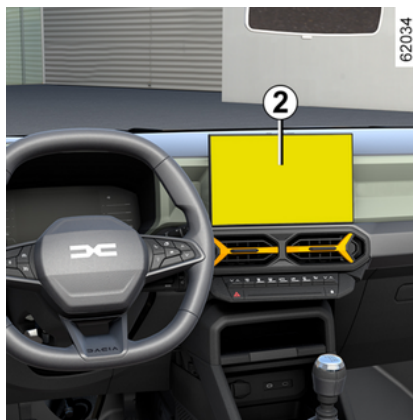

This system uses several guidelines for its operation (mobile for trajectory and fixed for distance). When the red zone is reached, use the bumper image to stop accurately.

Note: make sure that the reversing camera is not obscured (by dirt, mud, snow, condensation, etc.).

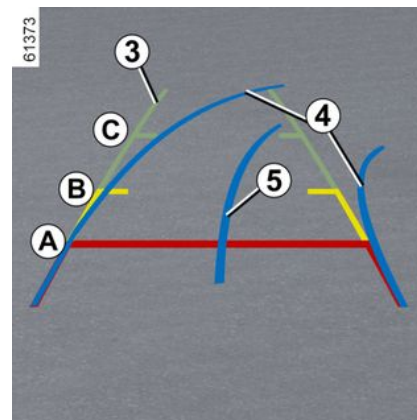

Fixed guide lines **3**

The fixed gauge includes coloured markers **A**, **B** and **C** indicating the distance behind the vehicle:

- **A** (red) at approximately 30 centimetres from the vehicle;
- **B** (yellow) at approximately 70 centimetres from the vehicle;
- **C** (green) at approximately 150 centimetres from the vehicle.

This gauge remains fixed and indicates the vehicle trajectory if the wheels are in line with the vehicle.

Moving guide lines **4**

This is shown in blue on the multimedia screen **2**. It indicates the vehicle trajectory according to the position of the steering wheel.

PARKING AIDS

Trailer guide lines 5

This is shown in blue on the multimedia screen 2. This indicates the trajectory of the trailer towbar according to the steering wheel position. It allows the driver to position the towbar as close as possible to the trailer's towing head.

« Trailer view »

If a trailer is connected, while in a forward gear press the "Camera" menu in the "Vehicle" world on your multimedia screen 2 to enable the camera 1 to transmit a view of the rear environment during approximately 30 seconds.

Settings

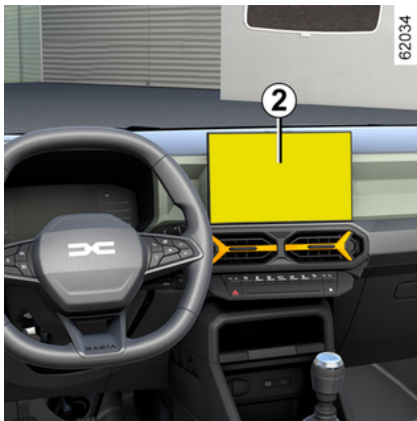

From the multimedia screen 2, when reverse gear is engaged, press the "Settings" button to add or remove guide lines and to adjust the camera image settings (brightness, contrast, etc.).

Please refer to the multimedia instructions for further information.

 Make sure that the camera is not obscured (by dirt, mud, snow, condensation etc.).

"Zoom auto" function

If an obstacle is detected behind the vehicle, the function "Zoom auto" switches the current display to a top rear view.

To activate/deactivate the "Zoom auto" function, please see the multimedia user manual.

 The screen shows a reverse mirror image.

The frames are a representation projected on a flat surface. This information is to not be taken into account when superimposed on a vertical object or an object on the ground.

Objects which appear on the edge of the screen may be deformed.

In very bright light (snow, vehicle in sunshine, etc.), the camera vision may be adversely affected. If the luggage compartment is open or incorrectly closed, the "WARNING: Boot Open" message appears.

Deactivating the system

The system may be deactivated:

- when the vehicle is travelling faster than about 12 mph (20 km/h);
- shortly after disengaging reverse gear.

Operating faults

When reverse gear is engaged, if the system detects an operating fault, a

PARKING AIDS

black screen is displayed temporarily on the multimedia screen **2**.

This may be caused by a fault affecting the camera or screen (clearness, fixed image, delayed communication etc.).

If the temporary display of the black screen persists, please consult an approved dealer.



This function is an additional aid. It cannot, therefore, under any circumstances replace the vigilance or the responsibility of the driver.

The driver should always be ready for sudden incidents while driving: always ensure that there are no small, narrow moving obstacles (such as a child, animal, pushchair, bicycle, stone, post, etc.) in the blind spot when manoeuvring.

Difference between the estimated distance and actual distance

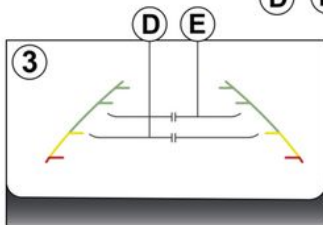

Reversing towards a steep uphill slope

The fixed guidelines **3** show the distances as closer than they actually are. The objects shown on the screen are actually further away on the slope.

For example, if the screen displays an object at **D**, the actual distance of the object is at **E**.

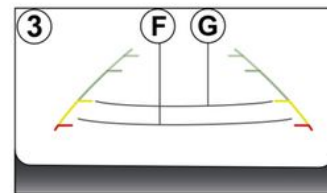
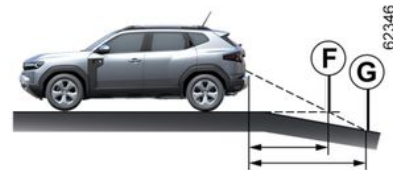

Reversing towards a steep downhill slope

The fixed guidelines **3** show the distances as further than they actually are.

Therefore, the objects shown on the screen are actually closer on the slope.

For example, if the screen displays an object at **G**, the actual distance of the object is at **F**.

PARKING AIDS

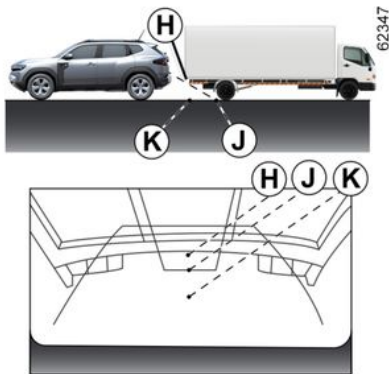

Reversing towards a protruding object

Position **H** seems further than position **J** on the screen. However, position **H** is at the same distance as position **K**.

The trajectory indicated by the fixed and mobile guidelines do not take into account the height of the object. So there is a risk that the vehicle may collide with the object when reversing towards position **K**.

Multi-view camera

Activating the system

With the ignition on, the system may be activated:

- in automatic mode, when changing into reverse gear: the system is activated and the camera located on the tailgate transmits a view of the area behind the vehicle onto the screen **4**;
- in manual mode, with the vehicle stationary and the engine on, from the "Vehicle" world on your multimedia screen **4**, press the "360° Camera" menu and the front view will appear on the multimedia screen.

Note: depending on the vehicle, certain settings can be adjusted from the screen **4**. Refer to the multimedia instructions.

Automatic mode



Automatic mode is activated when reverse gear is engaged and the screen **4** shows the rear camera view. When there is a quick change from reverse gear to forward gear, the screen **4** shows the image transmitted from the front camera.

Automatic mode is deactivated:

- by selecting another camera view from the menu on the screen **4**;
- automatically as soon as you reach about 7 mph (12 km/h);
- shortly after disengaging reverse gear.

Manual mode

To activate it, select the desired camera view from the menu on the screen **4**.

A message appears on the screen **4** for approximately five seconds to confirm the activation of manual mode.

Manual mode is deactivated:

- automatically as soon as you reach about 7 mph (12 km/h);
- around 3 minutes after disengaging reverse gear, in manual mode;
- by pressing the "Back" button after disengaging reverse, in manual mode.

PARKING AIDS

Reversing camera 3



If the rear camera is activated automatically or manually, the view from the camera is displayed on the screen **4**.

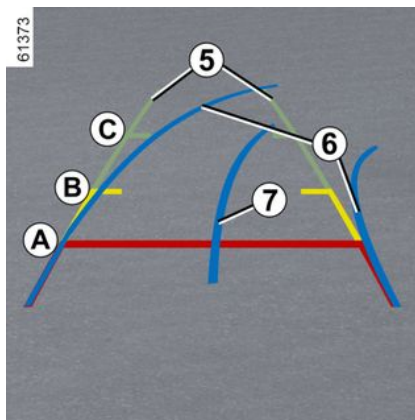

Fixed guide lines 5

The fixed gauge includes coloured markers **A**, **B** and **C** indicating the distance behind the vehicle:

- **A** (red) at approximately 30 centimetres from the vehicle;
- **B** (yellow) at approximately 70 centimetres from the vehicle;
- **C** (green) at approximately 150 centimetres from the vehicle.



The image displayed on the multimedia screen may seem faster than reality.

Moving guide line 6

(depending on the vehicle)

This is shown in blue on the multimedia screen **4**. It indicates the vehicle trajectory according to the position of the steering wheel.

Trailer guide lines 7

This is shown in blue on the multimedia screen **4**. This indicates the trajectory of the trailer towbar according to the steering wheel position. It allows the driver to position the towbar as close as possible to the trailer's towing head.

« Trailer view »

If a trailer is connected, while in a forward gear press the "Camera" menu in the "Vehicle" world on your multimedia screen **4** to enable the camera **3** to transmit a view of the rear environment during approximately 30 seconds.

"Zoom auto" function

If an obstacle is detected behind the vehicle, the function "Zoom auto" switches the current display to a top rear view.

To activate/deactivate the "Zoom auto" function, please see the multimedia user manual.

PARKING AIDS



The screen shows a reverse mirror image.

The frames are a representation projected on a flat surface. This information is to not be taken into account when superimposed on a vertical object or an object on the ground.

Objects which appear on the edge of the screen may be deformed.

In very bright light (snow, vehicle in sunshine, etc.), the camera vision may be adversely affected.

If the luggage compartment is open or incorrectly closed, the "Tailgate open" message appears.

Front camera 1



If the front camera is activated automatically or manually, the view from the camera is displayed on the screen 4.

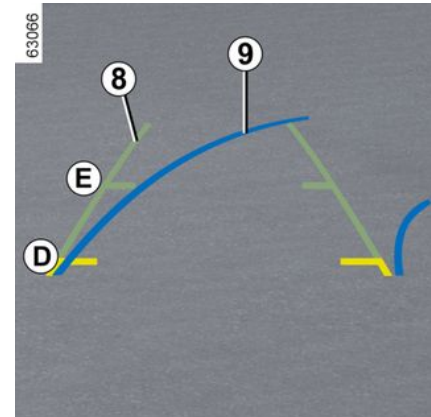

Fixed guide lines 8

The fixed guide line comprises coloured markers **D** and **E** indicating the distance in front of the vehicle:

- **D** (yellow) at approximately 70 centimetres from the vehicle;
- **E** (green) at approximately 150 centimetres from the vehicle.



The image displayed on the multimedia screen may seem faster than reality.

Moving guide line 9

(depending on the vehicle)

PARKING AIDS

This is shown in blue on the multimedia screen **4**. It indicates the vehicle trajectory according to the position of the steering wheel.

"Zoom auto" function

If an obstacle is detected in front of the vehicle, the function "Zoom auto" switches the current display to a top front view.

To activate/deactivate the "Zoom auto" function, refer to the multimedia instructions.



The screen shows a reverse mirror image.

The frames are a representation projected on a flat surface. This information is to not be taken into account when superimposed on a vertical object or an object on the ground.

Objects which appear on the edge of the screen may be deformed.

In very bright light (snow, vehicle in sunshine, etc.), the camera vision may be adversely affected. If the luggage compartment is open or incorrectly closed, the "Tailgate open" message appears.

Side cameras 2



The cameras **2** installed in the door mirrors transmit the side views to the screen **4**.

To activate the desired camera view, select it on the screen **4**. See the multimedia equipment instructions for further information.

Difference between the estimated distance and actual distance

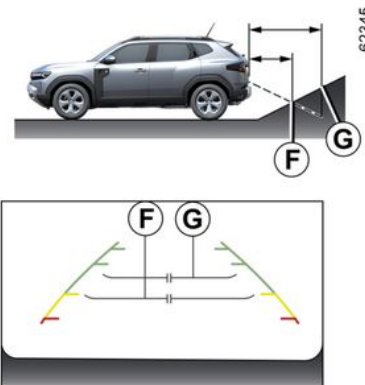

Driving or reversing towards a steep uphill slope

The fixed guidelines **5** show the distances as closer than they actually are.

The objects shown on the screen are actually further away on the slope.

For example, if the screen displays an object at **F**, the actual distance of the object is at **G**.

PARKING AIDS

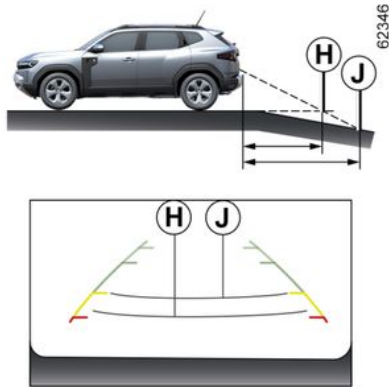

Driving or reversing towards a steep downhill slope

The fixed guidelines **5** show the distances as further than they actually are.

Therefore, the objects shown on the screen are actually closer on the slope.

For example, if the screen displays an object at **J**, the actual distance of the object is at **H**.

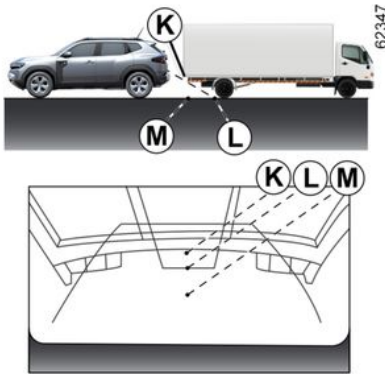

Driving or reversing towards a protruding object

Position **K** seems further than position **L** on the screen. However, position **K** is at the same distance as position **M**.

The trajectory indicated by the fixed and mobile guidelines do not take into account the height of the object. So there is a risk that the vehicle may collide with the object when reversing towards position **M**.

EMERGENCY CALL

If the vehicle is equipped, the emergency call function can be used to call the emergency services (without charge) automatically or manually in the event of an accident or illness, reducing the time it takes for the emergency services to arrive.

Note: emergency calling is available:

- in countries covered by the associated telematics emergency services and infrastructure compatible with the system;
- depending on the network coverage in the geographical region where the vehicle is being driven.

If you use the emergency call function to report an accident which you have witnessed, this implies stopping where traffic conditions allow to allow the emergency services to locate your vehicle and therefore the location of the reported accident.

In all cases, comply with local legislation.



Use the emergency call only in the event of an emergency you are involved in, if you witness an accident or if you feel ill.

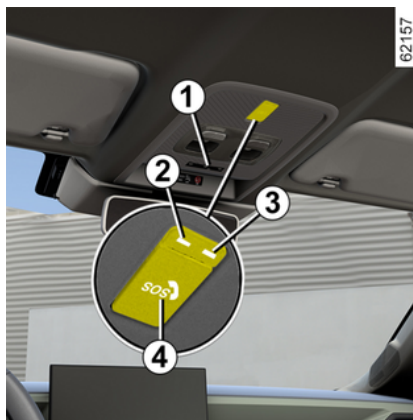

- 1 Microphone.
- 2 System operation/fault warning light:
 - red: operation fault.
- 3 System operation warning light:
 - green: operational (e.g. network available);
 - off: non-operational (e.g. network unavailable);
 - flashing green: call in progress.
- 4 Switch.
- 5 Speaker.



A call always takes place as follows:

- the call is initiated with the emergency services;
- data related to the incident (manufacturer's plate, time of the call, last locations, vehicle direction, etc.) is sent;
- voice communication takes place with the emergency services;
- if necessary, emergency assistance is called.

There are two emergency call modes:

- automatic mode;
- Manual mode.

Automatic mode

The emergency call starts automatically in the event of an accident that has

EMERGENCY CALL

required the activation of the protective equipment (seat belt pretensioners, airbag etc.).



In the event of an accident, if the location and traffic conditions permit, stay close to the vehicle in order to be able answer the call centre quickly if necessary.

Manual mode



- To make a call manually:
- briefly press the flap **4**;
 - guide it downwards;
 - press button **6** "SOS".

If the button was pressed by mistake, it is possible to cancel the call by pressing and holding the button **6** for around two seconds, before the call is connected to the call centre.

Once a call is established, only the call centre can end it.

Operating faults

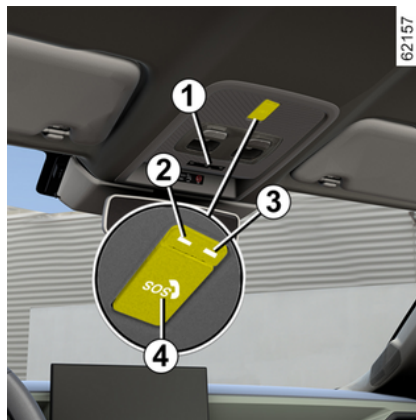

In some cases, the emergency call may not work (e.g. low battery, etc.). When the system detects an operating fault, the warning light **2** appears in red for over 30 minutes. Consult an approved dealer as soon as possible.



The system operates with a dedicated battery. The battery service life is approximately 4 years (the **2** warning light lights up in red to inform you). Consult an approved dealer.



To guarantee your safety and the proper operation of the system, any operation carried out on the battery (removal, disconnection, etc.) must be carried out by a qualified specialist.

Risk of serious burns or electric shocks.

You must respect the replacement intervals (without exceeding them) as stated in the maintenance document.

The battery is a specific type. Please ensure it is replaced with the same type.

Call an approved Dealer.

EMERGENCY CALL



Without the emergency call feature, the system is not trackable and will not be under constant surveillance. Data is automatically and constantly erased, and the system stores only the last three positions of the vehicle.

Data is only sent in the event of an emergency call. Data sent to the call centre is treated according to the personal data protection laws applicable in the country where you are located. The system stores activity history data for 13 hours only.

The vehicle owner has the right of access to their data. They can request that the data be corrected, deleted or locked.

AIR VENTS, HEATING AND AIR CONDITIONING

AIR VENTS, HEATING AND AIR CONDITIONING

Air vents: air outlets

Air outlets

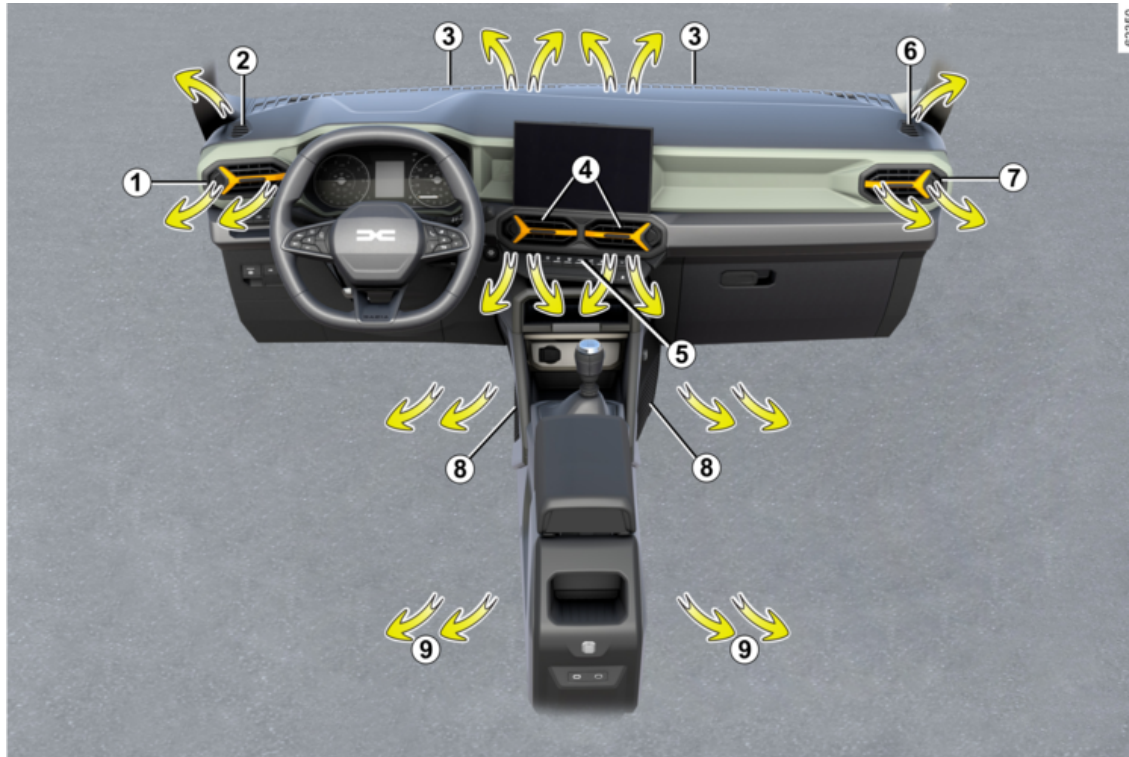

AIR VENTS, HEATING AND AIR CONDITIONING

- 1** Left-hand air vent.
- 2** Left-hand side window demister outlet.
- 3** Windscreen demisting vents.
- 4** Centre air vents.
- 5** Control panel
- 6** Right-hand side window demister outlet.
- 7** Right-hand air vent.
- 8** Footwell heater outlets for front passengers.
- 9** Footwell heater outlets for rear passengers (depending on the vehicle).

AIR VENTS, HEATING AND AIR CONDITIONING

Centre 4 and side 1 and 7 air vents



Air flow

Air vent 1

Opening: move the cursor **10** towards the outside of the vehicle.

Closing: Move the cursor **10** towards the inside of the vehicle as far as it will go.

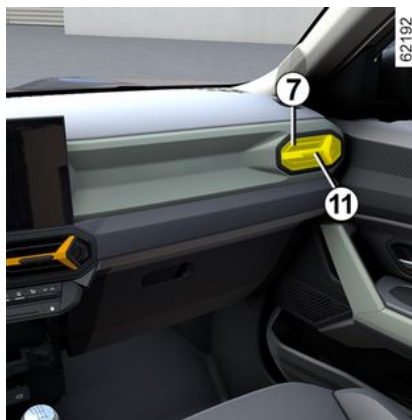

Air vent 7

Opening: move the cursor **11** towards the outside of the vehicle.

Closing: Move the cursor **11** towards the inside of the vehicle as far as it will go.



Air vents 4

Opening: move the cursor **12** towards the outside of the vehicle.

Closing: Move the cursor **12** towards the inside of the vehicle as far as it will go.



Do not add anything to the vehicle's ventilation circuit (for example, to remove bad odours).

There is a risk of damage or of fire.

AIR VENTS, HEATING AND AIR CONDITIONING

i Do not attach any objects to the air vents (e.g. telephone mounting).

Risk of damage.

i To remove bad odours from your vehicles, only use the systems designed for this purpose.

Consult an approved dealer.

Rear seats

(depending on the vehicle)



Passenger footwell heater outlets **9**.



Do not add anything to the vehicle's ventilation circuit (for example, to remove bad odours).

There is a risk of damage or of fire.

Heating, ventilation, air conditioning

System A

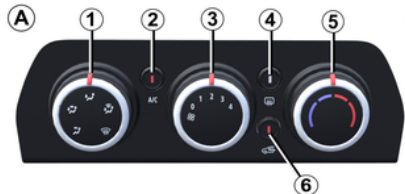

Controls

The controls will depend on the vehicle equipment level.

1. Distribution of air.
2. Switching air conditioning on or off.
3. Adjusting the ventilation fan speed.
4. De-icing/demisting of the rear screen and, depending on the vehicle,

the rear view mirrors.

5. Adjusting the air temperature.
6. Switching passenger compartment isolation mode/air recirculation mode on

Information and advice for use
→ 280.

Adjusting the air temperature

Turn control **5** to obtain the desired temperature. The further towards the red the slide is, the higher the temperature will be.

Adjusting the ventilation fan speed

Move control **3** from 0 to 4. The further the control is positioned to the right, the greater the amount of air blown into the passenger compartment. To stop air from entering the passenger compartment, set the **3** control to "0".

The system is deactivated: the ventilation speed for the passenger compartment air is zero (vehicle stationary), you can however still feel a slight flow of air when the vehicle is moving.

AIR VENTS, HEATING AND AIR CONDITIONING

i Prolonged use of this control in position 0 can lead to condensation forming on the side windows and windscreen and problems due to the use of non-renewed air in the passenger compartment.

i Prolonged use of air recirculation can lead to condensation forming on the side windows and windscreen, and discomfort due to the use of non-renewed air in the passenger compartment. We therefore advise you to return to normal mode (external air) as soon as the air recirculation function is no longer required, by pressing the **6** button.

Using the heating and air conditioning system increases the speed of demisting.

Heated rear screen

 **With the engine running,** press the button **4** (the warning light comes on).

This function de-ices/demists the rear screen and the electric de-icing rearview mirrors (depending on the vehicle).

Depending on the vehicle, the function is stopped:

- after a period of time set by the system (the indicator light disappears);
- by pressing button **4** again (the indicator light disappears).

Switching passenger compartment isolation mode/air recirculation mode on.

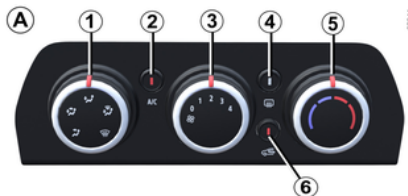

The button **6** can be used to activate (warning light on) or deactivate (warning light off) the isolation of the passenger compartment/air recirculation function.

Under these conditions, air is taken from the passenger compartment and is recirculated, with no air being taken from outside the vehicle.

Air recirculation operates as follows:

- isolating the vehicle from the external atmosphere (e.g. when driving in polluted areas, etc.);
- to bring the passenger compartment to the desired temperature as quickly as possible.

Rapid demisting

Turn controls **1**, **3** and **6** to positions:

- demisting ;
- maximum fan speed;
- external air.

Distribution of air in the passenger compartment

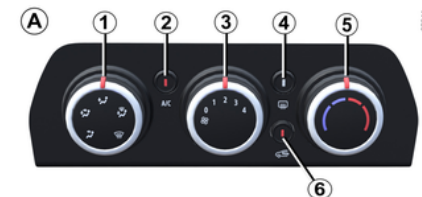

Turn control **1** to choose the distribution option.

AIR VENTS, HEATING AND AIR CONDITIONING



The air flow is directed to the dashboard vents.



The air flow is directed towards the dashboard vents and the footwells.



The air flow is directed mainly towards the footwells.



The air flow is distributed between front side window demisting vents, the windscreen demisting vents and the footwells.



All the air is then directed to the windscreen and front side window demisting vents.

Switching the air conditioning on or off

The air conditioning is switched on (indicator light lit) or off (indicator light off) using button **2**

Activation is not possible if the **3** control is set to 0.

The air conditioning system is used for:

- lowering the temperature inside the passenger compartment;
- eliminating condensation more quickly.

The air conditioning does not operate when the exterior temperature is low.



Fuel consumption increases when the air conditioning is being used (switch it off when it is not required).

System B



Controls

The controls will depend on the vehicle equipment level.

1. Distribution of air.
2. Switching air conditioning on or off.
3. Adjusting the ventilation fan speed.
4. De-icing/demisting of the rear screen and, depending on the vehicle, the rear view mirrors.
5. Adjusting the air temperature.
6. Switching passenger compartment isolation mode/air recirculation mode

on

Information and advice for use
→ 280.

Adjusting the air temperature

Turn control **5** to obtain the desired temperature. The further towards the red the slide is, the higher the temperature will be.

Adjusting the ventilation fan speed

Move control **3** from 0 to 4. The further the control is positioned to the right, the greater the amount of air blown into the passenger compartment. To stop air from entering the passenger compartment, set the **3** control to "0".

The system is deactivated: the ventilation speed for the passenger compartment air is zero (vehicle stationary), you can however still feel a slight flow of air when the vehicle is moving.



Prolonged use of this control in position 0 can lead to condensation forming on the side windows and windscreen and problems due to the use of non-renewed air in the passenger compartment.

AIR VENTS, HEATING AND AIR CONDITIONING

Switching passenger compartment isolation mode/air recirculation mode on.



The stalk **7** allows you to switch isolation of the passenger compartment/air recirculation on and off.

A warning light **6** lights up to confirm operation.

Under these conditions, air is taken from the passenger compartment and is recirculated, with no air being taken from outside the vehicle.



Prolonged use of air recirculation can lead to condensation forming on the side windows and windscreen, and discomfort due to the use of non-renewed air in the passenger compartment.

You are therefore advised to return to normal mode (external air) as soon as the air recirculation function is no longer required, by turning the control **7** to the right.

Air recirculation operates as follows:

- isolating the vehicle from the external atmosphere (e.g. when driving in polluted areas, etc.);
- to bring the passenger compartment to the desired temperature as quickly as possible.

Rapid demisting

Turn controls **1**, **3** and **7** to positions:

- demisting ;
- maximum fan speed;
- external air.

Using the air conditioning increases the speed of demisting.

Heated rear screen



With the engine running, press the button **4** (the warning light comes on).

Depending on the vehicle, this function de-ices/demists the rear screen and the exterior rearview mirrors.

Depending on the vehicle, the function is stopped:

- after a period of time set by the system (the indicator light disappears);
- by pressing button **4** again (the indicator light disappears).

Distribution of air in the passenger compartment



Turn control **1** to choose the distribution option.



The air flow is directed to the dashboard vents.



The air flow is directed towards the dashboard vents and the footwells.

AIR VENTS, HEATING AND AIR CONDITIONING



The air flow is directed mainly towards the footwells.



The air flow is distributed between front side window demisting vents, the windscreen demisting vents and the footwells.



All the air is then directed to the windscreen and front side window demisting vents.

Switching the air conditioning on or off

The air conditioning is switched on (indicator light lit) or off (indicator light off) using button **2**

Activation is not possible if the **3** control is set to 0.

The air conditioning system is used for:

- lowering the temperature inside the passenger compartment;
- eliminating condensation more quickly.

The air conditioning does not operate when the exterior temperature is low.



Fuel consumption increases when the air conditioning is being used (switch it off when it is not required).

Automatic climate control

The controls



1. Driver's heating temperature indicator (configuration **A**).
2. Ventilation speed indicator.
3. Heated steering wheel activation control.
4. Driver's heated seat activation control.

5. Air-conditioning activation control.
6. Passenger's heated seat activation control.
7. Heated windscreen activation control.
8. Passenger compartment air distribution indicator.
9. Stopping the system.
10. Passenger compartment air distribution adjustment.
11. Activation control for the "A/C MAX" function.

12. Air recirculation.

13. Air conditioning activation control in AUTO mode (configuration **A**).

14. De-icing/demisting of the rear screen and, depending on the vehicle, the rear view mirrors.

15. "Clear View" function.

16. Adjusting the ventilation speed and stopping the system.

17. Adjusting the driver's air temperature.

Activating the system

When the vehicle is started, the system returns to the last programme used.

The system is also functional when parked.

AIR VENTS, HEATING AND AIR CONDITIONING

Press the control **13** (configuration **A**) to activate the system or set the control **16** to the desired ventilation speed.

Stopping the system

Press the button **9**:

- the air conditioning or heating stops automatically;
- the air ventilation speed in the passenger compartment is zero;
- there is, however, a slight flow of air when the vehicle is moving.

This position should not normally be used.

Switching the air conditioning on or off

The control **5** authorises activation (warning light on) or deactivation (warning light off) of the air conditioning.

The system cannot be switched on if the ventilation power is zero.

The air conditioning system is used for:

- lowering the temperature inside the passenger compartment;
- eliminating condensation more quickly.

Recommendation: to optimise vehicle range, deactivate the air conditioning when the outside temperature is comfortable.

Automatic mode



Configuration A

The automatic climate control system guarantees comfort in the passenger compartment and good visibility (except in the event of extreme conditions), while optimising fuel consumption.

The system controls the ventilation speed, air distribution, air recirculation, and starting and stopping the air conditioning and air temperature.

This mode consists of a choice of three programmes:

AUTO: optimises the selected comfort level according to exterior conditions. Press the button **13**.

SOFT: enables the desired temperature level to be obtained more smoothly and silently. Press button **13** then press downwards again to activate **SOFT** mode.

FAST: increases the air flow in the passenger compartment. This mode is recommended in particular to optimise

comfort in the rear seats. Press button **13** then press upwards again to activate **FAST** mode.

When the air conditioning starts in automatic mode, the system returns to the last programme used.



Any action on a button other than the **AUTO** button triggers deactivation of automatic mode.

Adjusting the distribution of air in the passenger compartment



Press **10** one or more times to select the air distribution. The air distribution

AIR VENTS, HEATING AND AIR CONDITIONING

selected **8** is displayed on the multimedia screen. The positions are in the following order:



All the air is then directed to the windscreen and front side window demisting vents.



The air flow is distributed between front side window demisting vents, the windscreen demisting vents and the footwells.



The air flow is distributed between the front side window demisting vents, the windscreen demisting vents, the dashboard air vents and the footwells.



The air flow is mainly directed to the dashboard air vents.



The air flow is directed towards the dashboard vents and towards the footwells.



The air flow is directed mainly towards the footwells.

Adjusting the air temperature

Press the button **17** then use the tab on the multimedia screen to adjust the air temperature. The further towards

the red the slide is, the higher the temperature will be.

When the air conditioning system is used for long periods, it may begin to feel cold. To increase the temperature, press **17** then raise the tab upwards on the multimedia screen.

Adjusting the ventilation fan speed



In automatic mode, the system uses the most suitable amount of air to reach and maintain the desired comfort level.

You will still be able to adjust the ventilation speed by pressing the control **16** to increase or reduce the ventilation speed.

"Clear View" function

Press the button **15** and the built-in warning light comes on.

This function quickly de-mists the windscreen, rear screen, front side windows and door mirrors (depending on the vehicle). It automatically activates the air conditioning and rear screen de-icing functions.

To exit this function, press the button **15** or the button **13** again (configuration **A**).



Some buttons have an operating light indicating their operative state.

Rear screen de-icing and demisting

Press button **14** and the built-in warning light comes on. This function enables rapid demisting or de-icing of the rear screen and de-icing of the rear view mirrors (on equipped vehicles).

To exit this function, press button **14** again. Demisting automatically stops.

AIR VENTS, HEATING AND AIR CONDITIONING

"A/C MAX" function

Press the button **11** to activate the function. Deactivate ECO mode to make the most of it.

The "A/C MAX" function enables the user to feel the maximum power of their air conditioning system without any constraint or compromise related to the acoustics and the feeling of the air being too cold on the hands and face.

This function involves automatic modifications:

- temperature programmed to fully cold;
- distribution of air to the occupants;
- air flow at its maximum power;
- activation of the air conditioning;
- air recirculation.

Air recirculation (isolation of the passenger compartment)



i Demisting/de-icing will still take priority over the air recirculation.

Manual use

Press button **12** and the built-in warning light comes on.

Prolonged use of this position may lead to odours, caused by non-renewal of air, and the formation of condensation on the windows.

We therefore advise you to return to automatic mode as soon as air recirculation is no longer needed, by pressing button **12** (configuration **A**).

To exit this function, press the button **12** again.

i Prolonged use of air recirculation can lead to condensation forming on the side windows and windscreen, and discomfort due to the use of non-renewed air in the passenger compartment. We therefore advise you to return to normal mode (external air) as soon as the air recirculation function is no longer required, by pressing button **12** again.

Air conditioning: information and advice on use

Advice on use

In some situations (air conditioning off, air recirculation activated, ventilation speed at zero or low etc.), you may notice that condensation starts to form on the windows and windscreen.

If there is condensation, use the **"Clear View"** function to remove it, then use the air conditioning in automatic mode to stop it forming again.

AIR VENTS, HEATING AND AIR CONDITIONING



Vehicles equipped with ECO mode

Once activated, ECO mode may reduce the performance of the automatic air conditioning
→ 177.



Do not add anything to the vehicle's ventilation circuit (for example, to remove bad odours).

There is a risk of damage or of fire.

Fuel consumption

You will normally notice an increase in fuel consumption (especially when driving in town) when the air conditioning is operating.

For vehicles fitted with air conditioning with no automatic mode, switch off the system when it is not required.

Advice for reducing consumption and helping to preserve the environment

Drive with the air vents open and the windows closed. If the vehicle has been parked in the sun, open the

doors for a few moments to let the hot air escape before starting the engine.

Maintenance

Refer to the maintenance document for your vehicle for the inspection frequency.



Use the air conditioning system regularly, even in cold weather, running it at least once a month for approximately 5 minutes.

Operating faults

As a general rule, contact your approved dealer in the event of an operating fault.

– Reduction in de-icing, demisting or air conditioning performance.

This may be caused by the cabin filter cartridge becoming clogged.

– No cold air is being produced.

Check that the controls are set correctly and that the fuses are sound. Otherwise, switch off the system.

Special features of Hybrid versions

The vehicle's air conditioning system is also used to cool the traction battery.

In order to preserve the life of your vehicle's traction battery.

A prolonged drop in air conditioning efficiency may lead to premature deterioration of the traction battery.

Presence of water under the vehicle

After prolonged use of the air conditioning system, it is normal for water to be present under the vehicle. This is caused by condensation.



Do not open the refrigerant circuit. The fluid may damage eyes or skin.



Before carrying out any operation in the engine compartment, you must switch off the ignition

→ 149 → 151.

AIR VENTS, HEATING AND AIR CONDITIONING

Refrigerant fluid

(A)

64907



Inflammable product



Consult the vehicle user manual



Maintenance

x.xxx kg	(1) Quantity of refrigerant fluid present in the vehicle.
GWP xxxx	(2) Global Warming Potential (CO2 equivalent).
CO2 eq x.xxx t	(3) Quantity in weight and in CO2 equivalent.

Additional information

Depending on label and depending on the type of refrigerant:

Refrigerant fluid R-1234yf

- (1) 0,475 kg
- (2) GWP 4
- (3) 0.002 t

The refrigerant fluid circuit (of which some components are hermetically sealed) may contain fluorinated greenhouse gases.

Depending on the vehicle, you will find the following information on label **A** affixed inside the engine compartment.

The presence and location of the information on label **A** depends on the vehicle.



Type of refrigerant fluid



(XXX) Type of oil in the air conditioning circuit

MULTIMEDIA EQUIPMENT

Multimedia settings

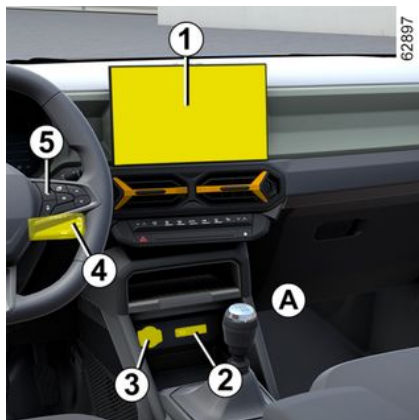

The presence and location of this equipment depends on the vehicle's multimedia equipment.

1. Multimedia screen.
2. Multimedia sockets USB-C in the centre console **A** or **B**.
3. Accessories socket → 293.
4. Steering column control.
5. Voice command.
6. Multimedia sockets USB-C for the rear passengers.



Using the telephone

We remind you of the need to conform to the legislation in force concerning the use of such equipment.

Multimedia port



The multimedia sockets USB-C **3** and **6** can be used to charge accessories with a maximum power of 12 Watts (5 Volts) per socket.

Note: the multimedia sockets USB-C **3** can also be used the transfer data.



Please refer to the multimedia instructions for further information.

MULTIMEDIA EQUIPMENT



Connect accessories with a maximum power of 12 watts only.
Fire hazard.



Using the telephone
We remind you of the need to conform to the legislation in force concerning the use of such equipment.

4 Hands-free telephone integrated control



Use the microphone **7** and the steering column control **5**.

Induction charging area **8**



→ 294.

Phone holder **A**

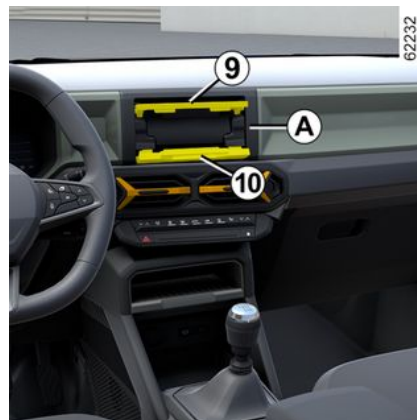

For vehicles equipped with it, open the bottom hatch **10**: lift the hatch **9**, place your phone **13** in the horizontal position in the slider **12** and then lower the hatch **9** while positioning the phone in the slide **11**.

MULTIMEDIA EQUIPMENT



For safety reasons, carry out any adjustments while the vehicle is stationary.

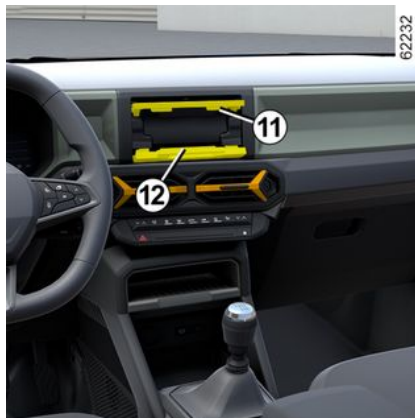

Make sure that the telephone is securely held in place between the **11** and **12** stands before use.



Make sure that the telephone is securely held in place in the telephone holder to ensure that it is not thrown onto the occupants during sudden turning or braking.



Using the telephone

We remind you of the need to conform to the legislation in force concerning the use of such equipment.

MULTIMEDIA EQUIPMENT

Removable phone holder **B**

On vehicles that are equipped, to fit the removable telephone holder **B**, observe the following instructions:

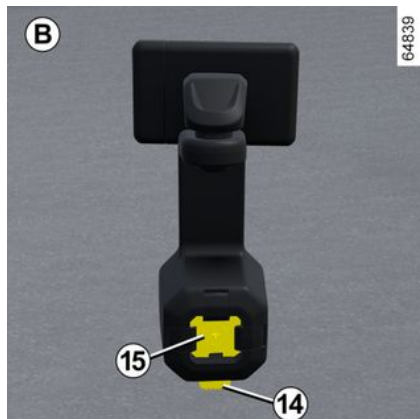

– press button **14** on telephone holder **B**;



– attach the base **15** of the telephone holder to the multi-accessory holder YouClip **16**;

– pull the clamp **19** to the right;



– place your telephone in the telephone holder **18** pressing the fixed clamp **17**, then release the clamp **19** so that the telephone is firmly held in place between clamps **17** and **19**.

To remove the removable telephone holder **B**, press button **14**.

Note: You can manually adjust the tilt of the telephone holder **18** to the desired position.

Only use the telephone holder approved by the Technical Department.

MULTIMEDIA EQUIPMENT



Make sure that the base of the telephone holder is correctly fitted and that the telephone is securely held in place in the telephone holder, so that it is not thrown on to the occupants during sudden turning or braking.



For safety reasons, carry out any adjustments while the vehicle is stationary.



Using the telephone
We remind you of the need to conform to the legislation in force concerning the use of such equipment.



If your vehicle is not fitted with an audio system, one can be fitted and space **20** has been provided for the radio.



Please refer to the multimedia instructions for further information.

PASSENGER COMPARTMENT EQUIPMENT

Electric windows

These systems operate with the ignition on or off, until one of the front doors is opened (limited to about 3 minutes).

4



Driver's responsibility

Never leave your vehicle with the card or key inside, with a child, adult who is not self-sufficient or a pet in the vehicle, even for a short while.

They may pose a risk to themselves or to others by starting the engine or activating equipment (such as the gear lever or electric windows).

If any part of the body becomes trapped, reverse the direction of the window immediately by pressing the relevant switch.

Risk of serious injury.

One-touch windows

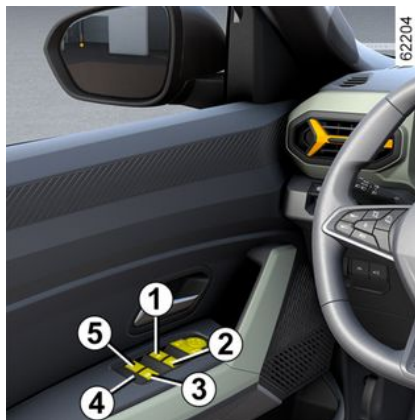

Briefly press or pull a window switch as far as it will go: the window will be fully raised or lowered. Pressing the switch again stops the window moving.

Note: the rear windows do not open fully.

From the driver's seat, use switch:

- 1** for the driver's side;
- 2** for the front passenger's side;
- 3** and **5** for the rear passengers.



Passenger safety

The driver can deactivate operation of the rear passenger electric windows by pressing switch **4**. A confirmation message is displayed on the instrument panel.

From the front passenger seat



Press the switch **6**.

Note: if the window detects resistance when almost fully closed (e.g. a tree branch), it stops and then lowers again by a few centimetres.

PASSENGER COMPARTMENT EQUIPMENT



Avoid resting any objects against a half-open window: there is a risk that the electric window could be damaged.

From the rear seats



Press the switch 7.



When closing the windows, ensure that no part of the body (arm, hand, etc.) is protruding from the vehicle.
Risk of serious injury.

Impossible to operate the one-touch electric window

The one-touch electric window has a thermal cut-out: If you press the window switch repeatedly (numerous actuations within a few minutes), it goes into protection mode (locking the window in the closed position).

You can:

- use the electric window switch briefly and with intervals of approximately 30 seconds;
- with the engine running, the window will be unlocked after approximately 20 minutes of inaction on the electric window switch.

Remote control window opening/closing

When unlocking the doors from the outside, if you **press and hold the card unlocking button**, all the windows equipped with a one-touch electric window will open automatically.

When locking the doors from the outside, if you **press and hold the card locking button**, all the windows equipped with a one-touch electric window will close automatically.

It is recommended that the user only operates the system when the vehicle can be seen clearly and no one is inside.



When closing the windows, ensure that no part of the body (arm, hand, etc.) is protruding from the vehicle.
Risk of serious injury.

Operating faults

In case of a fault when closing a window, the system reverts to normal mode: pull the switch concerned up as often as necessary to fully close the window (the window will close gradually), hold the switch (still on the closure side) for one second then lower and raise the window fully to reinitialise the system.

If necessary, contact an approved Dealer.

PASSENGER COMPARTMENT EQUIPMENT

Manually operated rear windows



Turn the handle **8** to lower or raise the window to the desired height.

Interior lighting

Courtesy light



Press switch **1** to enable:

- continuous lighting;
- or temporary lighting, controlled by opening one of the front doors, or by opening one of the four doors, depending on the vehicle. The light only goes out when the doors are correctly closed;
- or else the light definitively turned off.

Map reading lights

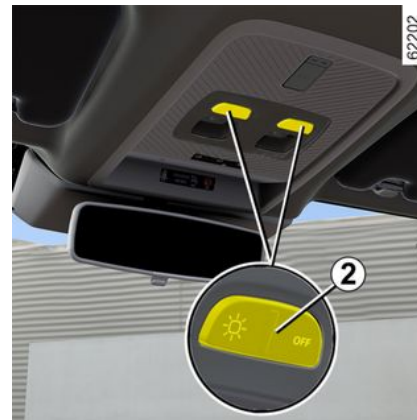

Front reading spot lights **2**

(depending on the vehicle)

Pressing switch **2** provides:

- continuous lighting;
- or temporary lighting, controlled by opening one of the front doors, or by opening one of the four doors, depending on the vehicle. The light only goes out when the doors are correctly closed;
- or else the light definitively turned off.

PASSENGER COMPARTMENT EQUIPMENT



Rear map reading lights **3**

(depending on the vehicle)

Pressing switch **3** provides:

- continuous lighting;
- or temporary lighting, controlled by opening one of the front doors, or by opening one of the four doors, depending on the vehicle. The light only goes out when the doors are correctly closed;
- or else the light definitively turned off.

Glovebox light **4**



The light **4** comes on when the cover is opened.

Luggage compartment light **5**

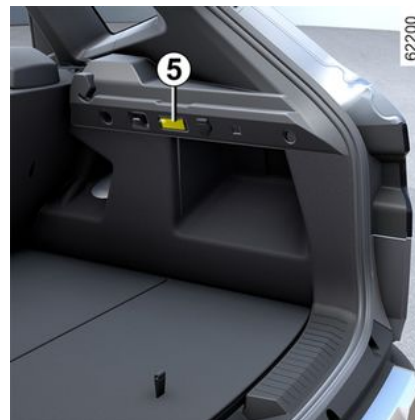

The light **5**, comes on when the luggage compartment is opened.

PASSENGER COMPARTMENT EQUIPMENT



Automatic operation of interior lighting

(depending on the vehicle)

- if the doors are unlocked using the remote control, the interior lighting is switched on for approximately 30 seconds.
- If a door is open (or not properly closed), the lighting is switched on for approximately 5 to 10 minutes.
- if all the doors are closed, the interior lighting starts to dim when the ignition is switched on.

4

Sun visor, mirror, grab handle

Sun visor 1



Lower the sun visor **1** over the windscreen or unclip it and flip it over to the side window.

Courtesy mirrors **2**

Depending on the vehicle, the sun visors are fitted with a courtesy mirror.

Lift the cover **3**.

Sun visor storage compartment **4**



This can be used for storing motorway tickets, cards, etc.

PASSENGER COMPARTMENT EQUIPMENT

Front 5 and rear 6 grab handles



This offers support and can be held when the vehicle is moving.

Do not use it for getting into or out of the vehicle.

Accessories socket

Accessories sockets 1 or, depending on the vehicle, 2

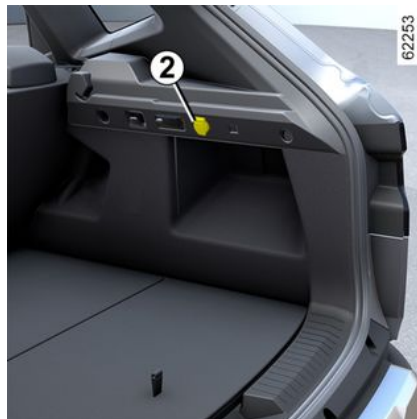

You can use socket 1 or, depending on the vehicle, socket 2.

It is provided for the purpose of connecting accessories approved by our Technical Department.



Connect accessories with a maximum power of 120 watts (12 V) only.

When several accessory sockets are used at the same time, the total power of the connected accessories must not exceed 180 watts.

Fire hazard.

PASSENGER COMPARTMENT STORAGE, FITTINGS

Front door storage compartments 1



Nothing should be placed on the floor (area in front of the driver) as these objects may slide under the pedals during sudden braking manoeuvres, thus obstructing their use.

Centre console storage compartment 2



Centre console storage compartment/Induction charging zone 3



Depending on the vehicle, the 4 symbol indicates that area 3 can be used to charge your phone without using a charging cable.

For more information on the induction charging zone, please refer to the multimedia instructions.

PASSENGER COMPARTMENT STORAGE, FITTINGS

 It is essential not to leave any objects (start-up card, USB drive, SD card, credit card, jewellery, keys, coins, etc.) **3** in the induction charging zone when charging your phone. Remove any magnetic cards or credit cards from the phone case before positioning your telephone in the induction charging area **3**.

 Objects left in the induction charging area **3** may over-heat. You are advised to place them in the areas provided for this purpose (storage compartment, sun visor compartment etc.).



Ensure that no hard, heavy or pointed objects are placed in the "open" storage compartments in such a way that they may fall onto passengers during sudden turning, braking or in the event of an accident.

Central storage compartment **5**

Placement for cup or ashtray **6**



Ensure that no hard, heavy or pointed objects are placed in the "open" storage compartments in such a way that they may fall onto passengers during sharp turning, sudden braking or in the event of an accident.

Passenger side storage compartment

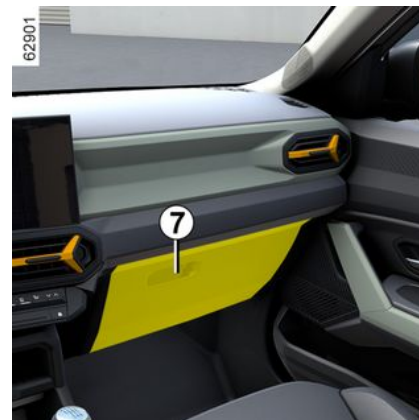

Pull handle **7** to open it.

This glove box can be used to store A4 format documents.

Inside the cover, a compartment is provided for pens, maps, etc.



Nothing should be placed on the floor (area in front of the driver) as these objects may slide under the pedals during sudden braking manoeuvres, thus obstructing their use.

PASSENGER COMPARTMENT STORAGE, FITTINGS

Centre console storage compartment 8



Lift the central armrest cover 9.

Rear storage compartment 10



Rear door storage compartment 11



Ensure that no hard, heavy or pointed objects are placed in the "open" storage compartments in such a way that they may fall onto passengers during sharp turning, sudden braking or in the event of an accident.

PASSENGER COMPARTMENT STORAGE, FITTINGS

Front seat storage compartments **12**



Bag hooks **13**

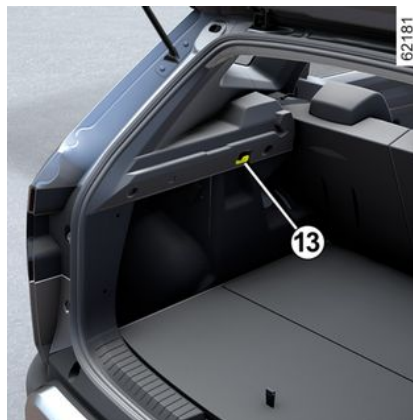

Maximum weight per hook: 5 kg.

Multi-accessory holder YouClip **14, 15, 16, 17 and 18**

Depending on the vehicle, they are designed to secure the cube **19**, the bulb **22**, the bag hook **24** (located in the luggage compartment) or accessories approved by the Technical Department.

Contact an approved Dealer for all advice.



Ensure that accessories YouClip are correctly fitted so that they may not be projected onto passengers during sudden turning, braking or in the event of an accident.



PASSENGER COMPARTMENT STORAGE, FITTINGS

4



Cube 19

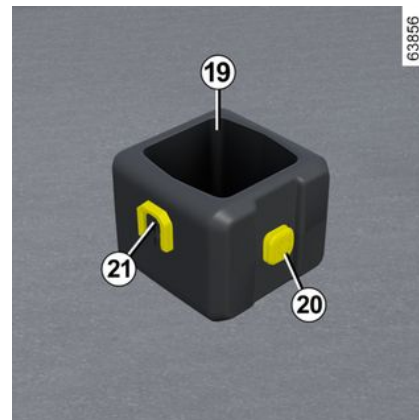

To install the base on equipped vehicles, slide the base **21** of the cube from top to bottom on the multi-accessory holder **14** or **15**.

You can use the cube as a cup holder.

To remove the cube, slide the base **21** of the cube from bottom to top on the multi-accessory holder.

Maximum weight per cube: 0.5 kg.

PASSENGER COMPARTMENT STORAGE, FITTINGS

Lamp 22

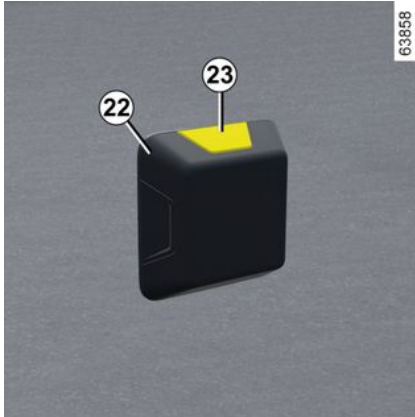

You can attach the lamp to the base **20** of the cube or to one of the multi-accessory holders **14**, **15**, **16**, **17** or **18**.

Press the button **23** to switch on the lamp.

Bag hooks 24

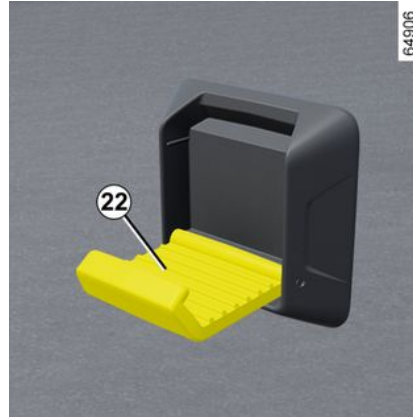

You can attach the bag hook to the base **20** of the cube or to one of the multi-accessory holders **14**, **15**, **16**, **17** or **18**.

Maximum weight per hook on the base of the cube: 1 kg.

Maximum weight per hook on the base **14**: 2 kg.

Maximum weight per hook on the base **16** or **17**: 5 kg.

TRANSPORTING OBJECTS

Luggage compartment storage

Rear parcel shelf

Removal

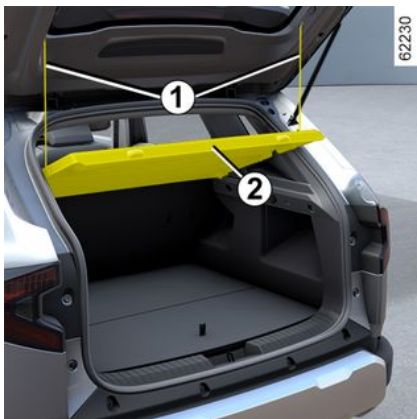

Detach the two cords **1** from the luggage compartment door.

The parcel shelf **2** is composed of two rigid sections.



Lift the parcel shelf **2** to half height and unclip the mountings **3** located at each end of the shelf.



Slightly lift the parcel shelf **2** and pull it towards you, holding the ends.

To refit, proceed in the reverse order to removal.



Do not place any heavy or solid objects on the parcel shelf.

These may pose a risk to the vehicle occupants if the driver has to brake suddenly or if the vehicle is involved in an accident.

TRANSPORTING OBJECTS

Luggage compartment storage space and fittings

Mobile floor 1

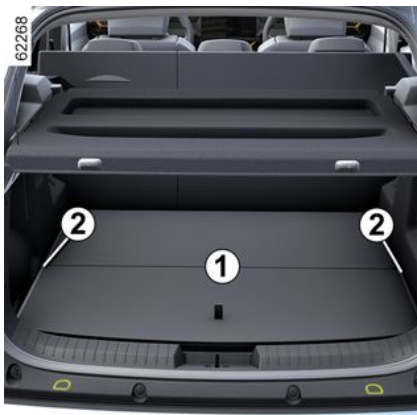

Raised position

Enables you to flatten the floor by folding down the back of the rear bench seat and to compartmentalise the boot into two distinct spaces.

The mobile floor is positioned on the runner **2**.



Maximum load allowed on the mobile floor in the raised position: 100 kg evenly distributed.

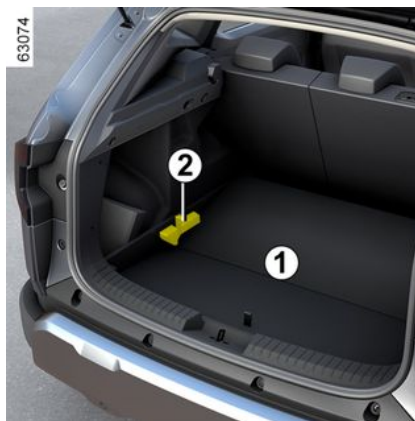

Lowered position

This allows for more space to store things in the luggage compartment and transport heavy loads.

- Remove the mobile floor **1**;
- place it in the luggage compartment underneath the runner **2**.



Compartmentalised position

This enables you to compartmentalise the luggage compartment into two separate spaces.

TRANSPORTING OBJECTS

Transporting objects in the luggage compartment

Always position the objects transported so that the largest surface is against:

62265



the rear bench seatbacks, for normal loads (example **A**);

62266



the front seatbacks with the rear seatbacks folded down, as is the case for maximum loads (e.g. **B**).

Ensure that the objects being transported are evenly distributed throughout the loading area.

If you have to place objects on the folded seat back, it is vital that you remove the headrests before folding the seat back so that it can be folded as flat as possible against the seat.



Always position the heaviest items directly on the floor in a low position → **301**/ If the vehicle

is equipped, use the lashing points **1** located on the luggage compartment floor. The luggage should be loaded in such a way that no items will be thrown forward and strike the occupants if the driver has to brake suddenly. Fasten the rear seat belts, even if the seats are not occupied.

TRANSPORTING OBJECTS

Towbar

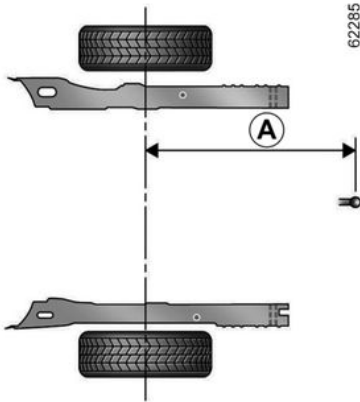

Maximum dimension **A** = 951 mm.

62286



i Permissible nose weight, maximum permissible towing weight, braked and unbraked → 380.

Choice and fitting of towing equipment

Maximum weight of towing equipment: 23 kg.

Any towing device must not obstruct any lighting component or the number plate when not in use. In all cases, you must comply with the regulations of the particular country you are in.

For fitting and conditions of use, refer to the equipment fitting instructions.

Please keep these instructions with the rest of the vehicle documentation.



Vehicles used fully laden (Maximum Permissible All-up Weight) and towing a trailer:

– The maximum speed must be limited to **62 mph (100 km/h)** and the **tyre pressure increased by 0.2 bar → 380.**

Risk of tyre blowouts.

Roof bars

Modular roof bars

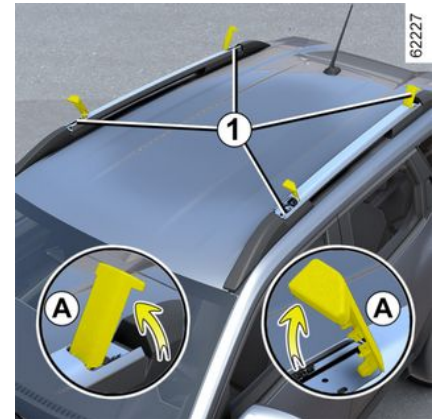

If the vehicle is equipped, this device enables you to position the roof bars in

TRANSPORTING OBJECTS

either the transverse position (carrying position) or the longitudinal position (standard position).

To place the bars in the transverse position:

- unclip the rotary covers **1** and put them in the vertical position (movement **A**);
- loosen the bolts **2** using the torque wrench **6** (see the following pages), located in the glovebox;

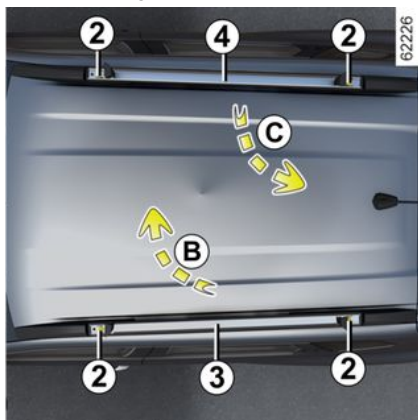

– raise bars **3** and **4** and fit them in transverse position **5**. To do this, place the bar **3** (movement **B**) in the front position, then place the bar **4** (movement **C**) in the rear position.

Note: make sure that bars **3** and **4** are correctly positioned.

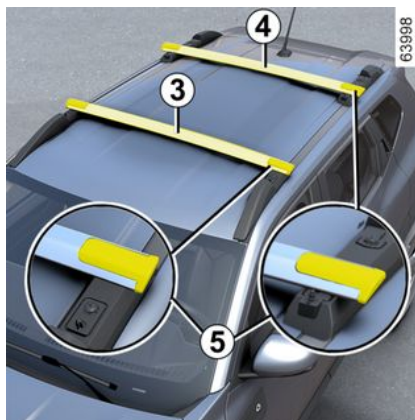

i Permissible weight on roof bars: → 380.



It is forbidden to attach any carrying device on roof for vehicles not originally fitted with longitudinal or modular roof bars.

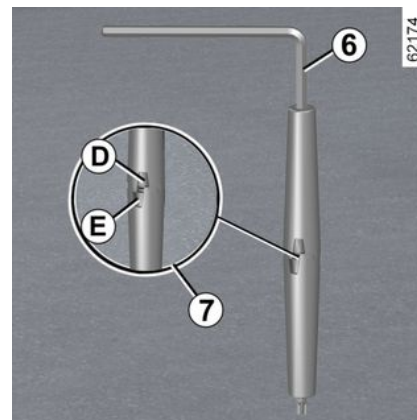

– use the tool **6** to tighten the bolts **2**: markers **D** and **E** located on the tool are offset (mark **7**);

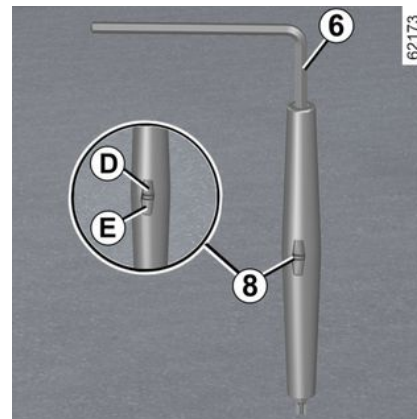

TRANSPORTING OBJECTS

- tighten the bolts **2** as far as possible using the tool **6** until markers **D** and **E** located on the tool **6** are parallel (mark **8**);
- re-clip the rotary covers **1**.

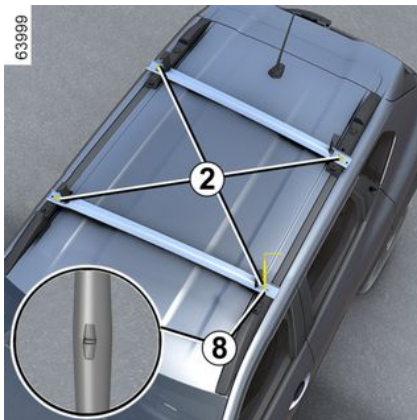

Note: bars **3** and **4** are not interchangeable.



It is strictly forbidden to place the roof bars in the transverse position (carrying position) when entering a roller-type car wash.



Make sure that the two modular roof bars are correctly positioned and locked.



Roof bars in the transverse position

- The maximum speed must be limited to 80 mph (130 km/h).
- During the journey, check the installation and tighten the bolts every 300 miles (500 km) or so.



When not using the bars in transverse position, refit the bars in longitudinal position in order to optimise fuel consumption and avoid air noise.



If lost, contact an approved dealer to obtain the bolts **2** and the tool **6**.



The modular roof bars are originally assembled and approved by our Technical Department.

They are provided together with the bolts **2** and the tool **6**. These must only be used for attaching the roof bars to the vehicle. Regularly check the condition of the modular roof bars (correct positioning of the bars, mounting points, bolts, etc.). Do not use them if they are damaged. Contact an approved Dealer.



Check that the objects and/or accessories (bike rack, roof box etc.) fitted to the modular roof bars are correctly positioned, evenly distributed and secured.

TRANSPORTING OBJECTS

Longitudinal roof bars



If fitted on the vehicle, you can transport luggage or additional equipment (bicycle rack, ski rack, etc):

- on transverse roof bars which must in turn be attached to the longitudinal roof bars **9**;
- directly onto the longitudinal roof bars.



For information on the range of equipment adapted to your vehicle, we advise you to consult an approved dealer. Refer to the manufacturer's instructions for information on how to fit and operate the equipment.

Please keep these instructions with the rest of the vehicle documentation.

Permissible weight on roof bars: → 380.



It is forbidden to attach any carrying device on roof for vehicles not originally fitted with longitudinal or modular roof bars.

Spoiler F



It is prohibited to attach any carrying equipment (bike rack, luggage box etc.) resting against the spoiler or tailgate. To install a carrying device on your vehicle, contact an Approved Dealer.

ACCESSING THE ENGINE, LEVELS

Bonnet



Depending on the vehicle, pull the lever **1** to open.



The engine must be switched off (not put on standby) before any operation is carried out in the engine compartment. You must switch off the ignition → 149, → 151.



Please note when working close to the engine that it may be hot. The engine cooling fan may also start at any moment. The



label in the engine compartment reminds you of this.

Risk of injury.



When working in the engine compartment, ensure that the windscreen wiper stalk is in the park position.

Risk of injury.



Never activate the remote engine start-up function or its programming before opening the bonnet or when it is open.

Risk of burns or serious injury.



Do not press down on the bonnet as there is a risk that the bonnet may accidentally close.

ACCESSING THE ENGINE, LEVELS

Unlocking the bonnet catch

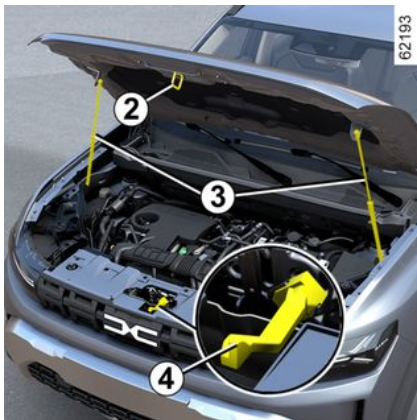

To unlock, raise the bonnet slightly and release the hook **2** by pushing the handle **4** towards the left.

Opening the bonnet

Raise the bonnet and guide it – the bonnet is held up by two struts **3**.

Closing the bonnet

Check that nothing has been left in the engine compartment.

Hold the middle of the bonnet and guide it down to one foot (30 cm) above the closed position, then release. It will latch automatically under its own weight.



Ensure that the bonnet is properly locked. Check that nothing is preventing the catch from locking (gravel, cloth, etc.).



After any procedure in the engine compartment, make sure that you do not forget anything (cloth, tools, etc.). Otherwise, this may lead to engine damage or cause a fire.



In the event of even a slight impact involving the radiator grille or bonnet, have the bonnet lock checked by an approved dealer as soon as possible.

it is normal to top up the level between scheduled oil changes.

However, contact your approved Dealer if more than 0.11 gal (0.5 litre) is being consumed every 600 miles (1,000 km) after the running in period.

Oil change frequency: check the oil level from time to time and certainly before any long journey to avoid the risk of damaging your engine.

Reading the oil level

The oil level should be read with the vehicle on level ground, after the engine has been switched off for some time.

The dipstick must be used to read the exact oil level and make sure that the maximum level has not been exceeded (risk of engine damage).

Depending on the vehicle, the instrument panel display only alerts the driver when the oil level is at its minimum.

Engine oil

General information

A combustion engine uses oil for lubrication and cooling of moving parts and

ACCESSING THE ENGINE, LEVELS

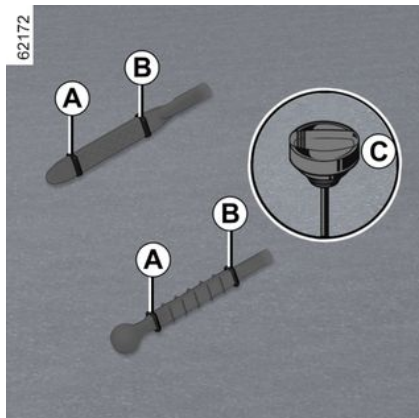

- Remove the dipstick and wipe with a clean, lint-free cloth;
- push the dipstick in as far as it will go (for vehicles equipped with a "cap-dipstick" **C**, screw the cap in as far as it will go);
- remove the dipstick again;
- read the level: it should never fall below the "minimum" mark **A** nor exceed the "maximum" mark **B**.

Once the operation has been completed, ensure that the dipstick is pushed in as far as it will go or that the "cap-type dipstick" is completely screwed in.



Use a funnel or protect the filling neck area to avoid engine oil escaping onto a hot part of the engine compartment or a sensitive part (e.g. electrical components).

Fire hazard.



Exceeding the maximum engine oil level

Under no circumstances should the maximum filling level **B** be exceeded: this could damage the engine and the emission control system. If the level exceeds the maximum level, **do not start your vehicle** and contact an authorised dealer.



Before carrying out any action in the engine compartment, you must switch off the ignition

➔ 149 or ➔ 151.

Topping up, filling, oil change

Topping up/filling

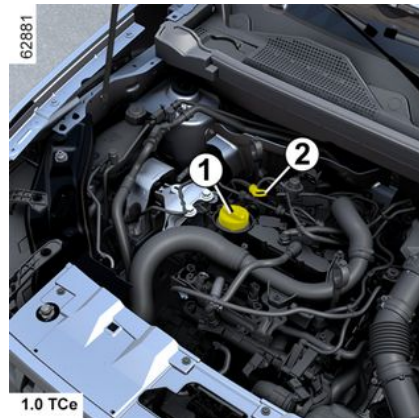

The vehicle must be parked on level ground and the engine should be stopped and cold (e.g. before the engine is started up for the first time that day).



The engine must be switched off (not put on standby) before any operation is carried out in the engine compartment.

You must switch off the ignition
➔ 149, ➔ 151.

ACCESSING THE ENGINE, LEVELS



Do not exceed the **"MAXI"** level and do not forget to refit the cap **1** and the dipstick **2**.

Once the operation has been completed, ensure that the dipstick is pushed in as far as it will go or that the "cap-type dipstick" is completely screwed in.



1.2 TCe



1.3 TCe

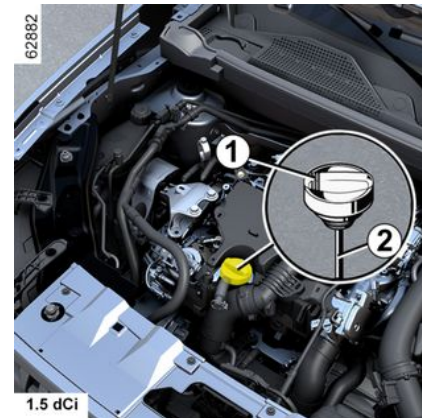

1.5 dCi

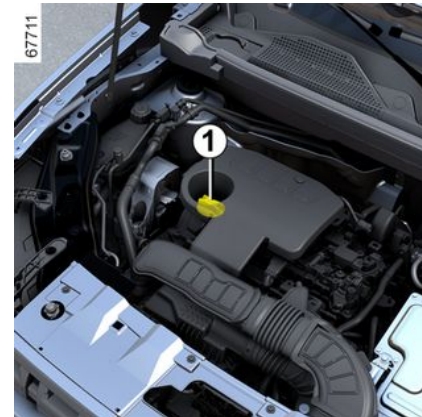

- Loosen the cap **1**;
- top up the level (as a guide, the capacity between the **"MINI"** and **"MAXI"** marks on the dipstick **2** is 0.33 to 0.44 gal (1.5 to 2 litres), depending on the engine);
- wait for approximately 20 minutes to allow the oil to flow;
- check the level using the dipstick **2** (as described previously).

ACCESSING THE ENGINE, LEVELS

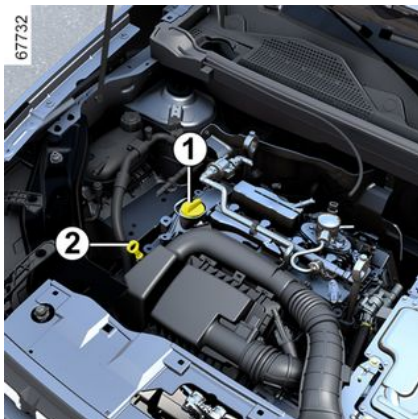

Exceeding the maximum engine oil level

Under no circumstances should the maximum filling level be exceeded: this could damage the engine and the emission control system.

If the oil level exceeds the maximum level, **do not start your vehicle** and contact an approved dealer.

Oil change capacity

Please refer to the maintenance document for your vehicle, or contact an authorised dealer.

Always check the engine oil level using the dipstick, as explained previously (it should never fall below the minimum level, or be over the maximum level on the dipstick).

Engine oil grade

Refer to the maintenance document for your vehicle.



The engine must be switched off (not put on standby) before any operation is carried out in the engine compartment.

You must switch off the ignition
➔ 149, ➔ 151.



Adding engine oil

Use a funnel or protect the filling neck area to avoid engine oil escaping onto a hot part of the engine compartment or a sensitive part (e.g. electrical components).

Fire hazard.



Never run the engine in an enclosed space as exhaust gases are poisonous.



When working in the engine compartment, ensure that the windscreen wiper stalk is in the park position.

Risk of injury.

Oil change

Service interval: refer to the maintenance document for your vehicle.

ACCESSING THE ENGINE, LEVELS



Filling and/or checking the oil level: when topping up or checking the oil level, ensure that no oil leaks onto the engine components.

Do not forget to properly close the cap and refit the dipstick to prevent any oil spatter on hot engine components.

Fire hazard.



When working close to the combustion engine, be aware that it may be hot. The engine cooling fan may also start at any moment.

The  label in the engine compartment reminds you of this.

Risk of injury.



If there is an abnormal or repeated drop in the fluid level, consult an approved dealer.



Engine oil change: if you are changing the oil when the engine is hot, be careful not to scald yourself as the oil drains.

Coolant level

Combustion engine coolant



With the engine off and the vehicle on flat ground, the level **when cold** must be between the "**MINI**" and "**MAXI**" marks on the coolant reservoir **1**.

Top this level up **when cold** before it reaches the "**MINI**" mark.

Frequency of checking coolant level

Check the coolant level regularly

(very severe damage is likely to be caused to the combustion engine if it runs out of coolant).

If the level needs to be topped up, only use products approved by our Technical Department which ensure:

- antifreeze protection;
- anti-corrosion protection of the cooling system.



No operations should be carried out on the cooling circuit when the combustion engine is hot.

Risk of burns.

Replacement intervals

Refer to the maintenance document for your vehicle.





The engine must be switched off (not put on standby) before any operation is carried out in the engine compartment.

You must switch off the ignition

➔ 149, ➔ 151.

ACCESSING THE ENGINE, LEVELS

 If there is an abnormal or repeated drop in the fluid level, consult an approved dealer.

 When working close to the combustion engine, be aware that it may be hot. The engine cooling fan may also start at any moment.

The  label in the engine compartment reminds you of this. **Risk of injury.**

Electric traction system coolant

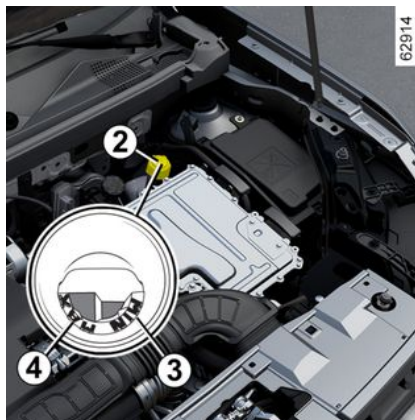

(Hybrid version)

This system is different to that of the combustion engine. It is used for cooling the electric motor.

 The engine must be switched off (not put on standby) before any operation is carried out in the engine compartment. You must switch off the ignition
→ 149, → 151.

Reading the level

With the ignition off and the vehicle parked on level ground, unscrew the coolant reservoir cap 2.

The level **when cold** must be between the "MIN" 3 and "MAX" 4 marks indicated inside the funnel.

Frequency of checking coolant level

Check the coolant level regularly (very severe damage is likely to be caused to the electrical circuit if it runs out of coolant).

If a top-up is required, you must contact an approved dealer to perform the top-up.



No operations should be carried out on the cooling circuit when the combustion engine is hot.

Risk of burns.

Replacement intervals

Refer to the maintenance document for your vehicle.



If there is an abnormal or repeated drop in the fluid level, consult an approved dealer.

ACCESSING THE ENGINE, LEVELS



When working close to the combustion engine, be aware that it may be hot. The engine cooling fan may also start at any moment.

The  label in the engine compartment reminds you of this.
Risk of injury.

The level should be read with the engine switched off and on level ground.



The engine must be switched off (not put on standby) before any operation is carried out in the engine compartment.
You must switch off the ignition
➔ 149, ➔ 151.

Topping up

After any operation on the hydraulic circuit, a specialist must replace the fluid.

Only use fluids approved by the Technical Department and which have been taken from a sealed container.

Replacement intervals

Refer to the maintenance document for your vehicle.



If there is an abnormal or repeated drop in the fluid level, consult an approved dealer.

5 Levels, filters

Brake fluid level

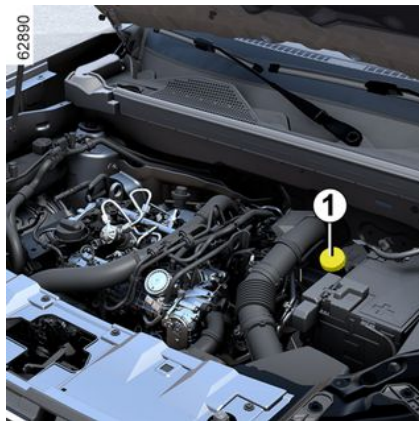

This should be checked frequently, and immediately if you notice even the slightest loss in braking efficiency.

Level

It is normal for the level to drop as the brake shoes become worn, but it must never drop below the "MINI" warning line shown on the brake fluid reservoir 1.

If you wish to check the disc and drum wear yourself, you should obtain the document explaining the checking procedure from the manufacturer's network or website.



When working in the engine compartment, ensure that the windscreen wiper stalk is in the park position.
Risk of injury.



The engine must be switched off (not put on standby) before any operation is carried out in the engine compartment.
You must switch off the ignition
➔ 149, ➔ 151.

ACCESSING THE ENGINE, LEVELS

Windscreen washer



Topping up

With the engine off, open the cap **2**. Fill until you can see the fluid, then replace the cap.

This reservoir supplies the front and rear headlight screen washers (if the vehicle is equipped with them).

Note: check the reservoir level regularly and top up the fluid before going on a trip.

Fluid: you should only use windscreen washer fluid containing anti-freeze.

We advise you to consult an approved dealer or a qualified professional.

Note: do not use hard water (risk of damage to the priming pump,

limescale building up on the pump and the jets).

Jets: to adjust the height of the windscreen washer jets, please consult an authorised dealer.



When working in the engine compartment, ensure that the windscreen wiper stalk is in the park

position.

Risk of injury.



The engine must be switched off (not put on standby) before any operation is carried out in the engine compartment.

You must switch off the ignition

➔ 149, ➔ 151.



When working close to the combustion engine, be aware that it may be hot. The engine cooling fan may also start at any moment.



The  label in the engine compartment reminds you of this.

Risk of injury.

Filters

The replacement of filter elements (air filter, cabin filter, diesel filter etc.) is scheduled in the maintenance operations for your vehicle.

Replacement intervals for filter components: refer to the maintenance document for your vehicle.

Cabin filter

If your vehicle is not originally fitted with a cabin filter, it is possible to have one retrofitted.

Contact an approved Dealer.

BATTERY

12 volt battery



The battery **1** does not require maintenance. **You should not open it or add any fluid.**



Handle the battery **1** with care as it contains sulphuric acid which must not come into contact with the eyes or the skin. If it does, wash the affected area with plenty of water and see a doctor if necessary.

Keep any flames, red hot objects or sparks away from the battery components (risk of explosion).

Depending on the vehicle, a system continuously checks the battery charge status. If this decreases, the "12V battery backup mode" message appears on the instrument panel followed by "Battery Low Start Engine". In this case, start the engine, drive the vehicle or wait until the message disappears from the instrument panel.

Note: after 5 to 30 minutes of vehicle use with the engine off, the "12V battery backup mode" message may be displayed to warn the user that the power consuming functions (interior lighting, radio, navigation, ventilation, accessories power supply, etc.) may be automatically cut off.

Your battery charging status may diminish, especially if you are using your vehicle:

- for short trips;
- in an urban setting;
- when the temperature is low;
- after extended use of energy-consuming devices (radio, etc.) with the ignition switched off.



The engine must be switched off (not put on standby) before any operation is carried out in the engine compartment.

You must switch off the ignition
➔ 149, ➔ 151.



Please note when working close to the engine that it may be hot. The engine cooling fan may also start at any moment. The



label in the engine compartment reminds you of this.

Risk of injury.

BATTERY

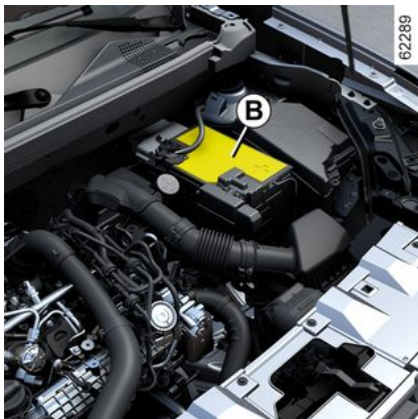

The **A** label is located on battery **1** under the protective cover **B**.

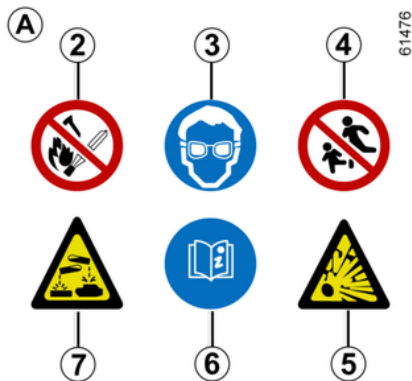

Label A

Observe the indications on the battery:

- **2** naked flames and smoking are prohibited;
- **3** eye protection compulsory;
- **4** keep away from children;
- **5** explosive material;
- **6** refer to the manual;
- **7** corrosive materials.



For your own safety and for the proper operation of the vehicle's electrical equipment (lights, windscreen wipers, ABS, etc.), any intervention on the battery (removal, disconnection, etc.) must categorically be performed by a specialist professional.

Risk of serious burns from electric shocks.

You must respect the replacement intervals (without exceeding them) as stated in the maintenance document.

The battery is a specific type. Please ensure it is replaced with the same type. Call an approved dealer.

Secondary 12 V battery



5

The secondary "12 V" battery **1** is located at the rear of the vehicle Hybrid: it supplies the power required to unlock/lock the vehicle and to operate the equipment.

You should not open it or add any fluid.

The secondary "12 V" battery **1** charge level may diminish, especially if you use your vehicle:

- when the outside temperature drops;
- after extended use of power-consuming functions while the ignition is switched off;
- after a prolonged period of parking.

BATTERY



For your own safety and to ensure the proper operation of the vehicle's electrical equipment

(lights, windscreen wipers, ABS, etc.), any operation on the secondary "12 V" battery (removal, disconnection, etc.) **must** be performed by a qualified specialist.

Risk of serious burns or electric shocks.

You **must** respect the replacement intervals (without exceeding them) as stated in the maintenance document.

The battery is a specific type.

Please ensure it is replaced with the same type.

Call an approved dealer.

Label A

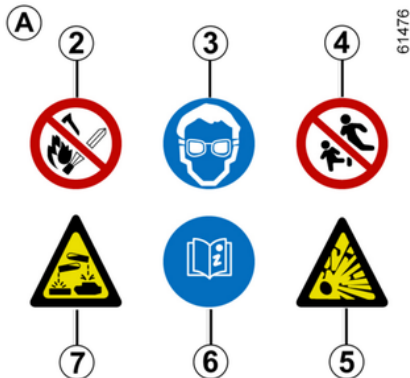

61476

Observe the indications on the battery:

2. naked flames and smoking are forbidden;
3. eye protection must be used;
4. keep away from children;
5. explosive materials;
6. refer to the manual;
7. corrosive substances.



Do not disconnect the "12 V" secondary battery; this is prohibited.

Risk of serious burns or electric shocks.

Secondary 48 V battery



Depending on the vehicle, a secondary battery **1** is located under the front passenger seat or under the driver's seat in a specific compartment: it supplies the energy required to operate some equipment.

The secondary battery **1** does not require any maintenance. **You should not open it or add any fluid.**

BATTERY



Label A

The label **A** is located on the battery **1**:

- **2** hazardous electrical voltage;
- **3** risk of explosion;
- **4** corrosive materials;
- **5** naked flames and smoking are prohibited;
- **6** do not dispose of as waste;
- **7** recyclable materials;
- **8** eye protection compulsory;
- **9** refer to the manual;
- **10** keep away from children.

Note: to ensure its performance and proper operation, the secondary battery **1** is fully recharged during driving, at regular intervals (approximately once every two months).

On such occasions, you may experience a temporary decrease in power and/or engine braking. This is completely normal.



For your own safety and for the proper operation of the vehicle's electrical equipment (lights, windscreen wipers, ABS, etc.), any intervention on the battery (removal, disconnection, etc.) must categorically be performed by a specialist professional.

Risk of serious burns or electric shocks.

The battery is a specific type. Please ensure it is replaced with the same type. Call an approved dealer.

CLEANING

Bodywork maintenance

A well-maintained vehicle will last longer. It is therefore recommended to maintain the exterior of the vehicle regularly.

Your vehicle has been treated with very effective anti-corrosion products. It is nevertheless subject to various outside influences.

Corrosive agents in the atmosphere

- atmospheric pollution (in built-up and industrial areas);
- saline atmospheres (near the sea, particularly in hot weather);
- seasonal and damp climatic conditions, (e.g.: road salt in winter, water from road cleaners, etc.).

Minor impacts

Abrasive action

Dust and sand in the air, mud, road grit thrown up by other vehicles, etc.

You should take a number of minor precautions in order to safeguard your vehicle against such risks.

You should do the following

Wash your car frequently, **with the engine off**, with cleaning products recommended by our Technical Department (never use abrasive products).

Rinse thoroughly beforehand using a jet washer:

- spots of tree resin and industrial pollution;
- mud in the wheel arches and underneath the body which forms damp patches;
- **bird droppings**, which cause a chemical reaction with the paint that **rapidly discolours paintwork and may even cause the paint to peel off**;

Wash the vehicle **immediately** to remove these marks as it is impossible to remove them by polishing;

- salt, particularly in the wheel arches and underneath the body after driving in areas where the roads have been gritted.

Remove any plant matter (resin, leaves, etc.) from the vehicle regularly.

Observe local regulations about washing vehicles (e.g. do not wash your vehicle on a public highway).

Repair, or have repaired quickly, areas where the paint has been damaged, to prevent corrosion spreading.

Remember to visit the body shop periodically in order to maintain your anti-corrosion warranty. Refer to the maintenance document.

Observe the vehicle stopping distances when driving on gravelled surfaces to prevent paint damage.

When washing the vehicle with a high-pressure cleaning device, please take the following precautions:

- make sure that your vehicle's paintwork, the area or the component that you want to clean is compatible with this type of washing;
- the pressure delivered by the device must be less than 100 bar;
- when washing, position the spray nozzle at least 15 cm from the vehicle and check that the water flow rate is less than 3.30 gal (15 l) per minute;
- do not persist in washing the same area, impacted points or the seals (risk of damage to the paint, seals becoming detached, etc.).

If mechanical components, hinges, etc. have been cleaned, they must be protected again by spraying with products approved by our Technical Department.



We have selected special products to care for your vehicle and you can obtain these from the manufacturer's accessory outlets.

CLEANING

Do not do the following

Wash the vehicle in bright sunlight or freezing temperatures.

Do not scrape off mud or dirt without pre-wetting.

Allow dirt to accumulate on the exterior.

Allow rust to form following minor impacts.

Use solvents not approved by our Technical Department to remove stains as they could damage the paintwork.

Do not drive in snow or muddy conditions without washing the vehicle, particularly under the wheel arches and body.



Degrease or clean using high-pressure cleaning equipment or by spraying products not approved by our Technical Department:

- mechanical components (e.g. engine compartment);
- wheels (e.g. braking system components such as brake callipers);
- underbody;
- parts with hinges (e.g. inside the doors);
- painted plastic external fittings (e.g. bumpers).

Doing this could give rise to corrosion or operational faults.

Vehicles with a matte paint finish

This type of paint requires certain precautions.

You should do the following

Wash the vehicle by hand using plenty of water, using a soft cloth or a gentle sponge.

Do not do the following

Use wax-based products (polishing).

Rub too hard.

Wash the vehicle in a roller-type car wash.

Attach stickers to the paintwork (risk of leaving marks).



Wash the vehicle using a high-pressure cleaning device.

Using a roller type car wash

Return the wiper stalk to the Park position ➔ 132 . Check the mounting of external accessories, additional lights and rear view mirrors, and ensure that the wiper blades are secured with adhesive tape.

Remove the radio aerial mast if your vehicle is fitted with this equipment.

Remember to remove the tape and re-fit the antenna after washing.

Cleaning the headlights, sensors and cameras

Use a soft cloth or cotton wool.

If this does not clean them properly, moisten the cloth with soapy water, then wipe clean with a soft damp cloth or cotton wool.

Finally, carefully dry off with a soft dry cloth.

Do not use alcohol-based cleaning products or utensils such as scrapers.

Cleaning stickers, decorative films, etc.

You should do the following

Use a soft cloth or cotton wool.

Moisten it with soapy water, then always wipe clean with a soft cloth or cotton wool.

Finally, carefully dry off with a soft dry cloth.

Do not do the following

Use alcohol-based cleaning products.

Use utensils (e.g. a scraper).

Rub too hard.

CLEANING



Wash the area using a high-pressure cleaning device.

Interior trim maintenance

A well-maintained vehicle will last longer. It is therefore recommended to maintain the interior of the vehicle regularly.

A stain should always be dealt with swiftly.

Whatever type of stain is on the trim, use **cold** (or warm) **soapy water with natural soap**.

Detergents (washing-up liquid, powdered products, alcohol-based products) should not be used.

Use a soft cloth.

Rinse and wipe up excess water.

Multimedia screen

Maintenance of the screen may depend on the type of multimedia equipment. Please refer to the multimedia instructions for further information.

Glass instrument panel

(e.g. instrument panel, clock, exterior temperature display, radio display, etc.)

Use a soft cloth or cotton wool.

If this does not clean them properly, use a soft cloth (or cotton wool) slightly moistened with soapy water and then wipe clean with another soft damp cloth or cotton wool.

Finally, **carefully** dry off with a soft dry cloth.

Do not use products containing alcohol and/or spray fluids on the area.

Seat belts

These must be kept clean.

Use products selected by our Technical Department (approved outlets) or warm, soapy water and a sponge and wipe with a dry cloth.

Detergents or dyes must not be used.

Textiles (seats, door trim, etc)

Vacuum-clean the textiles **regularly**.

Liquid stain

Use soapy water.

Dab lightly (never rub) with a soft cloth, rinse and remove the excess.

Solid or pasty stain

Carefully remove the excess solid or pasty material **immediately** with a

spatula (working from the edges to the centre to avoid spreading the stain).

Clean as for a liquid stain.

Special instructions for sweets or chewing gum

Put an ice cube on the stain to solidify it, then proceed as for a solid stain.



For further recommendations for maintaining the interior, and/or for any unsatisfactory results, please see an authorised dealer.

Removal/replacing removable equipment originally fitted in the vehicle

If you need to remove equipment in order to clean the passenger compartment (for example, mats), always ensure that they are correctly refitted and are the right way around (the driver's mat should be fitted on the driver's side etc.) and fit them with the components supplied with the equipment (for example, the driver mat should always be fixed using the pre-fitted mounting components).

With the vehicle stationary, always ensure that nothing will impede driving

CLEANING

(anything obstructing the pedals, heel wedged by the mat etc.).

Do not do the following

Position objects such as deodorants, scents etc. near air vents as this could damage your dashboard trim.



Use high-pressure cleaning equipment or sprays inside the passenger compartment:

– without careful use, this equipment could impair the correct functioning of the electrical or electronic components in the vehicle, or have other detrimental effects.

TYRES

Tyres

Tyre and wheel safety

The tyres are the only contact between the vehicle and the road, so it is essential to keep them in good condition. You must make sure that your tyres conform to local road traffic regulations.



For your safety and to comply with the law.

When they need to be replaced, only tyres of

the same make, size, type and profile should be used on a single axle.

They must either have a load capacity and speed rating at least equal to those of the original tyres, or conform to those recommended by an authorised dealer.

Failure to heed these instructions could endanger your safety and affect your vehicle's roadworthiness.

Risk of loss of control of the vehicle.

Maintaining the tyres



61489

The tyres must be in good condition and the treads must have sufficient depth: tyres approved by our Technical Department have wear warning strips **1** which are **indicators moulded into the tread at several points.**

When the tyre tread has been worn to the level of the wear indicators **these become visible 2 : it will then be necessary to replace your tyres as the tread depth will be 1.6 mm at most, resulting in poor road-holding on wet roads.**

An overloaded vehicle, long journeys by motorway, particularly in very hot weather, or continual driving on poorly

surfaced minor roads will lead to more rapid tyre wear and affect safety.



Incidents which occur when driving, such as striking the kerb, may damage the tyres and wheel rims, and could also lead to misalignment of the front or rear axle geometry. In this case, have the condition of these checked by an approved dealer.

Tyre pressures

Adhere to the tyre pressures (including the emergency spare wheel). The tyre pressures should be checked at least once a month and additionally before any long journey (refer to the label affixed to the edge of the driver's door → 327).

TYRES



Incorrect tyre pressures lead to abnormal tyre wear and unusually hot running. These are factors which may seriously affect safety and lead to:

- poor road holding;
- the risk of blow-outs or of throwing a tread.

The tyre pressure depends on the load and driving speed. Adjust pressures according to use conditions → 327.

Pressures should be checked when the tyres are cold. Ignore higher pressures which may be reached in hot weather or after driving at high speed. If tyre pressures cannot be checked when the tyres are **cold**, assume an increase of **0.2** to **0.3** bar.

Never deflate a hot tyre.

Special feature

Depending on the vehicle, there may be an adapter which needs to be positioned on the valve before air is added.



Your vehicle is equipped with large wheels. These are more sensitive to imbalance. If you experience vibration while driving, contact an approved dealer.



Please be aware that a poorly tightened or missing valve cap can make the tyres less airtight and may lead to pressure loss. Always use valve caps which are identical to the originals.



Vehicle fitted with a tyre pressure loss warning system

In the event of under-inflation (punctures, under-inflation etc.),

the  warning light appears on the instrument panel → 183.



Changing a wheel

As the tyre pressure loss warning system may take several minutes to correctly determine the positions of the wheels and the pressure values after driving, check the tyre pressures following any operation.

Emergency spare wheel

→ 333 → 335.

TYRES

Fitting new tyres



For your safety and to comply with the law. When they need to be replaced, only tyres of the same make, size, type and profile should be used on a single axle.

They must either have a load capacity and speed rating at least equal to those of the original tyres, or be recommended by an authorised dealer.

Failure to heed these instructions could endanger your safety and affect your vehicle's roadworthiness.

Risk of loss of control of the vehicle.

Changing wheels around

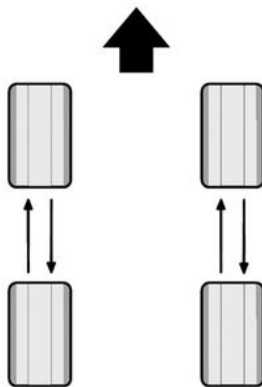

62284

Version 4x4

We recommend that you swap the wheels regularly in order to ensure that the tyres wear evenly.

Swap the wheels as shown in the above diagram. Refer to your vehicle's maintenance document for information on service intervals.

Version 4x2

This practice is not recommended.

Use in winter

Chains

2-wheel drive version (2WD)

Snow chains must be fitted to the front wheels.

4-wheel drive version (4WD)

Snow chains may be fitted to only the front wheels, or to all four wheels.

Chains cannot be fitted to tyres which are larger than those originally fitted to the vehicle.



Chains may only be fitted to tyres of the same size as those originally fitted to **your vehicle**.

"Snow" or "Winter" tyres

We would recommend that these be fitted to all **four wheels** to ensure that your vehicle retains maximum adhesion.

Caution: these tyres sometimes have a specific direction of rotation and a maximum speed index which may be lower than the maximum speed for your vehicle.

Studded tyres

This type of equipment may only be used for a limited period and as laid down by local legislation.

TYRES

It is necessary to observe the speed specified by current legislation.

These tyres must be fitted at least to both wheels on the front axle or, depending on the country, to all wheels on the vehicle.



In all cases, we would recommend that you contact your approved dealer who will be able to advise you on the choice of equipment which is most suitable for your vehicle.

Tyre pressure

Label A



Open the door to read it.

Tyre pressures should be checked when the tyres are cold.

If the tyre pressures cannot be checked when the tyres are **cold**, increase the pressures from **0.2 to 0.3** bar (or **3 PSI**). Never deflate a hot tyre.

Tyre pressures must correspond to the current usage of the vehicle (empty, carrying a load, motorway driving, etc.). Respect the tyre pressures (including the emergency spare wheel). These must be checked at least once a month and before any long journey.

Depending on the vehicle, after each reinflation or readjustment of the tyre pressure, you should reset the tyre pressure reference value → **183**.



Vehicle fitted with a tyre pressure loss warning system

In the event of under-inflation (punctures, under-inflation etc.),

the  warning light appears on the instrument panel → **183**.

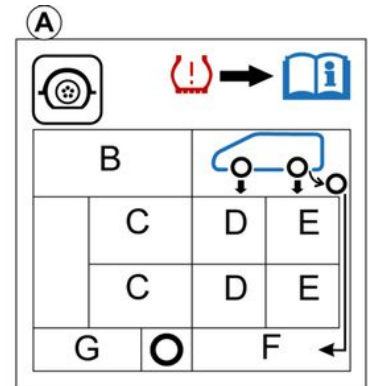

TYRES

The presence and location of the information on the label depends on the vehicle.

B: size of the tyres fitted to the vehicle.

C: intended driving speed.

D: front tyre pressure.

E: rear tyre pressure.

F: tyre pressure for the emergency spare wheel.

G: size of the emergency spare wheel tyre.



Vehicles used fully laden (Maximum Permissible All-up Weight) and towing a trailer:

– The maximum speed must be limited to **62 mph** (100 km/h) and the tyre pressure increased by **0.2 bar** → **380**.

Risk of tyre blowouts.

Tyre safety and chain fitting: for information on maintenance conditions and, depending on the vehicle version, the use of chains → **324**.



For your safety and to comply with the law. When they need to be replaced, only tyres of the same make, size, type and profile should be used on a single axle.

They must either have a load capacity and speed rating at least equal to those of the original tyres, or conform to those recommended by an approved dealer.

Failure to heed these instructions could endanger your safety and affect your vehicle's roadworthiness.

Risk of loss of control of the vehicle.

Tyre inflation kit



TYRES



The kit is only approved for inflating the tyres of the vehicle originally equipped with the kit.

It must never be used to inflate the tyres of another vehicle, or any other inflatable object (rubber ring, rubber boat, etc.).

Avoid spillage on skin when handling the repair product bottle. If droplets do leak out, rinse them off with plenty of water.

Keep the repair kit away from children.

Do not dispose of the empty bottle in the countryside. Return it to your approved dealer or to a recycling organisation.

The bottle has a limited service life which is indicated on its label. Check the expiry date.

Contact an approved dealer to replace the inflation tube and repair product bottle.



The kit repairs tyres when the tread **A** has been damaged by objects smaller than 4 mm.

It cannot repair all types of puncture, such as cuts larger than 4 mm, cuts in the tyre sidewall **B**, etc.

Ensure also that the wheel rim is in good condition.

Do not pull out the foreign body causing the puncture if it is still in the tyre.



Do not attempt to use the inflation kit if the tyre has been damaged as a result of driving with a

puncture.

You should therefore carefully check the condition of the tyre sidewalls before any operation. Driving with underinflated, flat or punctured tyres can be dangerous and may make the tyre impossible to repair.

This repair is temporary.

A tyre which has been punctured should always be inspected (and repaired, where possible) by a specialist as soon as possible.

When taking a tyre which has been repaired using this kit to be replaced, you must inform the specialist.

When driving, vibration may be felt due to the presence of the repair product injected into the tyre.

TYRES



Depending on the vehicle, in the event of a puncture, use the kit **C** located in the boot.



Vehicle fitted with a tyre pressure loss warning system

In the event of under-inflation (punctures, under-inflation etc.),

the  warning light appears on the instrument panel ➔ 183.

62281

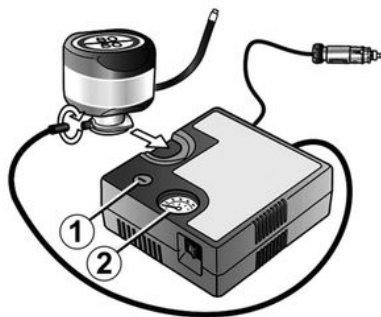

With the engine running and the parking brake applied:

- Disconnect any accessories that are connected to the vehicle's accessories sockets;
- on vehicles fitted with a towing device, disconnect the towbar socket if needed;
- **see the information on the inflation kit compressor** located in the vehicle luggage compartment and follow the instructions for use;
- inflate the tyre to the recommended pressure ➔ 327;
- after a maximum of **15 minutes**, stop inflating and read the pressure (on the pressure gauge **2**).

Note: while the container is emptying (approximately 30 seconds), the pressure gauge **2** will briefly indicate a pressure up to 6 bar, then the pressure drops;

- adjust the pressure: to increase it, continue inflation with the kit. To reduce it, press the button **1**.

If the recommended pressure of 1.8 bar cannot be achieved after 15 minutes, repair is impossible. Do not drive the vehicle. Consult an approved dealer.



Before using the kit, park the vehicle at a sufficient distance from traffic, switch on the hazard warning lights, apply the parking brake, ask all passengers to leave the vehicle and keep them away from traffic.

TYRES



If the vehicle is parked on the hard shoulder, you must warn other road users of your vehicle's presence with a warning triangle or with other devices as per the legislation applying to the country you are in.

Once the tyre is correctly inflated, remove the kit: unscrew the inflation adapter slowly from the container to prevent any product spatter and store the container in plastic packaging to prevent product leaks.

- Affix the driving recommendation label (located under the container) to the dashboard where the driver can see it.
- At the end of this initial inflation operation, air will still escape from the tyre. You must drive a short distance in order to seal the hole.
- Put the kit away.
- Start immediately and drive at a speed between 12 to 37 mph (20 to 60 km/h) in order to distribute the product evenly in the tyre. After driving a distance of 2 miles (3 km), stop and check the pressure.
- If the pressure is higher than 1.3 bar but lower than the recommended pressure (refer to the label affixed to the

edge of the driver's door), adjust it. Otherwise, contact an approved dealer: the tyre cannot be repaired.

Precautions when using the kit

The kit should not be operated for more than 15 consecutive minutes.



Nothing should be placed around the driver's feet as during sudden braking such objects may slide under the pedals and obstruct their use.

The container must be replaced after the first use even if liquid remains inside.



Please be aware that a poorly tightened or missing valve cap can make the tyres less airtight and may lead to pressure loss. Always use valve caps identical to the originals and screw them down fully.



Following repair with the kit, do not travel further than 124 miles (200 km).

In addition, reduce your speed and under no circumstances exceed 50 mph (80 km/h).

The sticker, which you must affix in a prominent position on the dashboard, reminds you of this. Depending on the country or local legislation, a tyre repaired with the inflation kit will need to be replaced.

TYRES

Tools

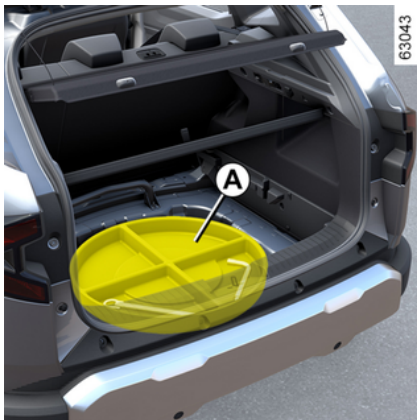

Depending on the vehicle, to access the tool kits:

- open the luggage compartment door;
- depending on the vehicle, lift up the movable floor and/or the luggage compartment mat.

Note: depending on the vehicle, storage trays **A** are located next to the spare wheel or on the spare wheel.



Wheelbrace 1

This can be used to lock or unlock the wheel bolts and the towing eye 4.



Jack 2

To use the jack, unscrew the nut **5** to the end of the rod **6** and rotate it upwards (movement **B**). When replacing the jack, fold it correctly before replacing it in its position (make sure to put back the wheel brace).

Tighten the nut **5** to secure the jack.



For your safety, the use of a jack not recommended by the manufacturer is strictly prohibited.

The jack is specific to the vehicle and used to change the wheels. Under no circumstances should it be used:

- on another vehicle;
- to carry out a repair;
- to access the underside of the vehicle.

Risk of injury.

Risk of damage to the vehicle.

Hubcap tool 3

This tool is used to remove the wheel trims.

Towing eye 4 → 339.

TYRES



Do not leave the tools unsecured inside the vehicle as they may be projected during braking.

After use, check that all the tools are correctly clipped into the tool kit, then position it correctly in its housing to reduce any risk of injury.

If bolts are supplied with the emergency spare wheel, you must use these bolts only for the emergency spare wheel.

Puncture, emergency spare wheel

In case of puncture

Depending on the vehicle, the following may be available:

- a tyre inflation kit → 328;
- an emergency spare wheel or self-repairing tyres.



Vehicle fitted with a tyre pressure loss warning system

In the event of under-inflation (punctures, under-inflation etc.),

the  warning light appears on the instrument panel → 183.



If the spare wheel has been stored for several years, have it checked by your Dealer to ensure that it is safe to use.

Vehicle equipped with an emergency spare wheel that differs from the other four wheels:

- Never fit more than one emergency spare wheel to the same vehicle.
- Replace the emergency spare wheel as soon as possible with a wheel identical to the original one.
- When this is fitted to the vehicle, which must only be a temporary measure, the driving speed must not exceed the speed indicated on the label on the wheel.
- Fitting an emergency spare wheel may alter the way the vehicle usually runs. Avoid sudden acceleration or deceleration and reduce your speed when cornering.
- If you need to use snow chains, fit the emergency spare wheel to the rear axle and check the tyre pressure.

TYRES



If the vehicle is parked on the hard shoulder, you must warn other road users of your vehicle's presence with a warning triangle or with other devices as per the legislation applying to the country you are in.

Combustion engine vehicles 4x2 version

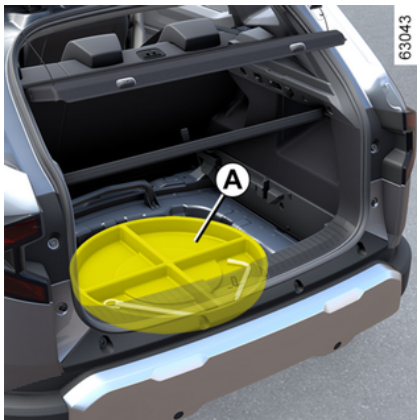

Depending on the vehicle, remove the tool kit **A** then the spare wheel **1**.

Note: depending on the vehicle, the punctured wheel must not be placed in the emergency spare wheel carrier. The punctured wheel must be placed in the luggage compartment.

Combustion engine vehicles 4x4 version

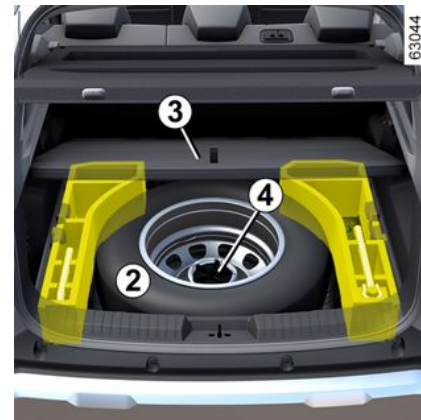

Emergency spare wheel **2**

To get to it:

- open the luggage compartment door;
- depending on the vehicle, lift up the movable floor and the boot mat **3**;
- unscrew the central mounting **4** in the anticlockwise direction;
- remove emergency spare wheel **2**.

Note: in the absence of an emergency spare wheel or tyre inflation kit, do not load the bottom of the luggage compartment. Depending on the vehicle, the tool kit is located on the left of the emergency spare wheel under the mobile floor.

TYRES

Hybrid version

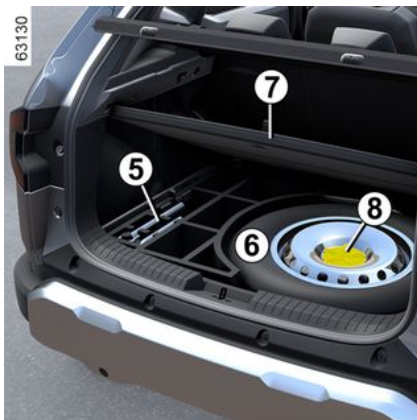

Tool kit 5

The tools included in the tool kit depend on the vehicle.

Tool kit 5 is located in the tray under the luggage compartment carpet.

For more information → 332.

Emergency spare wheel 6

To get to it:

- open the luggage compartment door;
- depending on the vehicle, lift up the movable floor and the boot mat 7;
- unscrew the central mounting 8 in the anticlockwise direction;
- remove emergency spare wheel 6.



If the vehicle is parked on the hard shoulder, you must warn other road users of your vehicle's presence with a warning triangle or with other devices as per the legislation applying to the country you are in.



Switch on the hazard warning lights. Keep the vehicle away from traffic and on a level surface where it will not slip. Apply the parking brake and engage a gear (first or reverse, or **P** for automatic transmissions). Ask the passengers to leave the vehicle and to keep away from traffic.

Changing a wheel



Vehicles equipped with a jack and wheel brace

If necessary, remove the wheel trim.

Unlock the wheel bolts using the wheel brace 1.

Position it so as to be able to push from above.

Position the jack 2 horizontally.

The jack head **must** be lined up with the sill closest to the wheel affected and indicated by the arrow 3.

TYRES



If the vehicle is parked on the hard shoulder, you must warn other road users of your vehicle's presence with a warning triangle or with other devices as per the legislation applying to the country you are in.

Start cranking the jack by hand, positioning the jack support plate **4** plate in the slightly indented groove underneath the vehicle, located between the two notches **5** and in the direction of the arrow **3**.

Continue to crank the jack so that the baseplate is correctly positioned (it should be underneath the vehicle and aligned with the jack head).

Turn it a few times to lift the wheel off the ground.

Undo the bolts and take off the wheel.

Fit the emergency spare wheel on the central hub and turn it to locate the mounting holes in the wheel and the hub.

Tighten the bolts, checking that the wheel is correctly positioned on its hub.

Lower the jack.

With the wheel on the ground, tighten the bolts fully and have the tightness of the bolts checked and the emergency spare wheel pressure checked as soon as possible.



If you have a puncture, replace the wheel as soon as possible. A tyre which has been punctured should always be inspected (and repaired, where possible) by a specialist.



Vehicle fitted with a tyre pressure loss warning system

In the event of under-inflation (punctures, under-inflation etc.),

the  warning light appears on the instrument panel → **183**.



Do not leave the tools unsecured inside the vehicle as they may be projected during braking.

After use, check that all the tools are correctly clipped into the tool kit, then position it correctly in its housing to reduce any risk of injury.

If bolts are supplied with the emergency spare wheel, you must use these bolts only for the emergency spare wheel.

TYRES



For your safety, the use of a jack not recommended by the manufacturer is strictly prohibited.

The jack is specific to the vehicle and used to change the wheels. Under no circumstances should it be used:

- on another vehicle;
- to carry out a repair;
- to access the underside of the vehicle.

Risk of injury.

Risk of damage to the vehicle.

Wheel trims, wheel trim – wheel



Central wheel trim 1 with visible wheel bolts

Remove it using the hubcap tool 2, inserting the tool near a wheel bolt
➔ 332.



To refit it, reposition the hooks 4 in relation to the bolts 3.

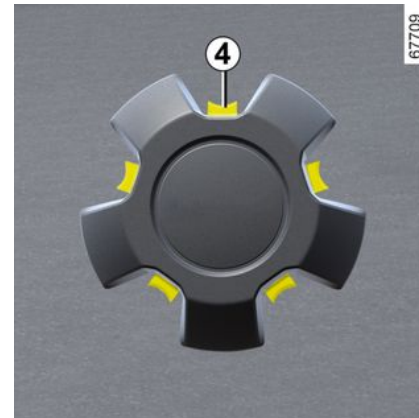

TYRES

Push in the wheel trim's retaining hooks.



Do not leave the tools unsecured inside the vehicle as they may be projected during braking.

After use, check that all the tools are correctly clipped into the tool kit, then position it correctly in its housing to reduce any risk of injury.

If bolts are supplied with the emergency spare wheel, you must use these bolts only for the emergency spare wheel.

6

BREAKDOWN RECOVERY

Towing: breakdown

Before towing, set the gearbox to neutral (position **N** on vehicles with an automatic gearbox), unlock the steering column and then release the parking brake.

On vehicles fitted with an automatic gearbox, if it is not possible to set the gear lever to **N** position, consult an approved dealer.

Steering column unlocking

Insert the key into the ignition, turn to "On" position or, depending on the vehicle, with the card present in the detection area, press the engine start button for approximately **two seconds** → 149 → 151.

Set the lever to neutral (position **N** for vehicles equipped with an automatic gearbox).

The steering column unlocks and the accessory functions are powered: you can use the vehicle's lights (direction indicators, brake lights, etc.). At night the vehicle must have its lights on.

Depending on the vehicle, once you have finished towing, press the engine start button twice (risk of running down the battery).

The speed specified by current legislation for towing must always be observed.

If you are driving the towing vehicle, do not exceed the maximum towing weight for your vehicle → 380.



- Use a rigid tow bar. If a rope or cable is used (where the law allows this), the vehicle being towed must be able to brake.
- a vehicle must not be towed if it is not fit to be driven.
- avoid accelerating or braking suddenly when towing, as this may result in damage being caused to the vehicle.
- In any case, it is advisable not to exceed **16 mph (25 km/h)**.
- Do not push the vehicle if the steering column is locked.

Front and rear towing points

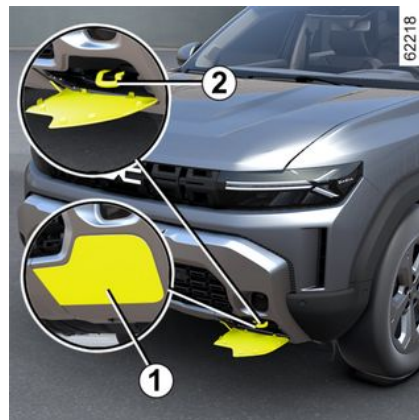

Use only

- at the front: towing point **2** or, depending on the vehicle, the towing eye **3** → 332 and the towing point;
- at the rear: towing point **4**.

These towing points may only be used for towing: never use them for lifting the vehicle directly or indirectly.

Front towing point 2

To access the towing point **2**, unclip the front cover **1** by inserting a flat-blade screwdriver or similar under the cover.

BREAKDOWN RECOVERY

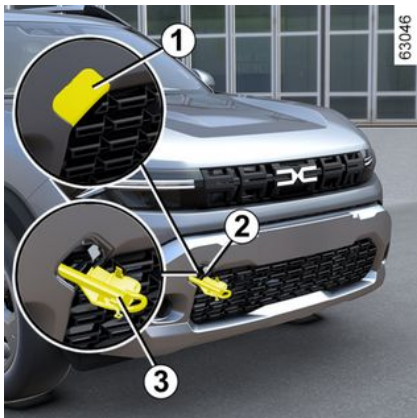

Tighten the towing hitch 3 fully: first by hand until it stops then finish by locking it with the wheel brace.

Use only the towing ring 3 and the wheelbrace → 332.



Ensure that the towing ring is bolted correctly.
Risk of losing the towed object.

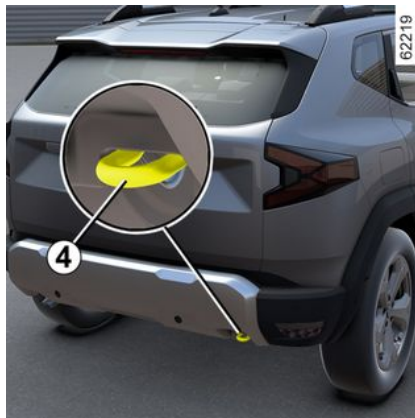

Rear towing point 4



When the engine is stopped, steering and braking assistance are no longer provided.



Do not leave the tools unsecured inside the vehicle as they may be projected during braking.

Towing a 4-wheel drive (4WD) vehicle

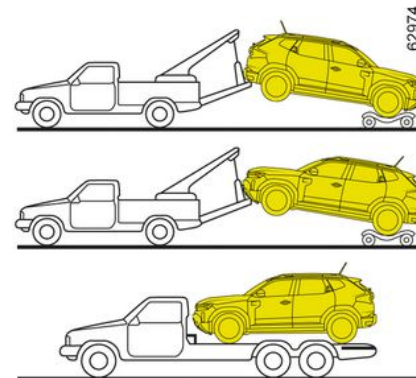

You must never tow a 4-wheel drive vehicle, irrespective of the mode selected, if one of the 4 wheels is in contact with the ground (except for off-road recovery).

Risk of mechanical damage.

BREAKDOWN RECOVERY



Do not remove the key from the ignition switch, or leave the card in the vehicle during towing (depending on the vehicle).

Risk of the steering column locking.

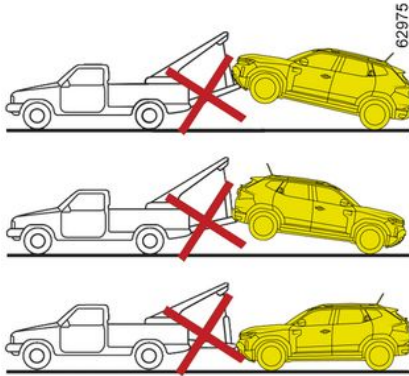

Off-road recovery

If your vehicle is stuck in sand, snow or mud, attach a flexible towing device (towing belt or other device specially designed for this purpose) to the front or rear towing point.



Refer to the manufacturer's instructions for information on how to fit and operate the equipment.

If a 4x4 (4WD) vehicle becomes stuck, it should only be towed for a short distance. **Risk of mechanical damage.**



For off-road recovery, it is forbidden to use a rigid bar to tow a vehicle that is stuck. **Risk of mechanical damage.**

Towing a vehicle with an automatic gearbox

Transport the vehicle on a trailer or tow it with the front wheels off the ground.

In exceptional circumstances and excluding Hybrid, vehicles, the vehicle can be towed with all four wheels on the ground, forwards only, with the gearbox in neutral **N** position, over a maximum distance of 50 miles (80 km) and not exceeding a speed of 16 mph (25 km/h).

Note: if the gear lever cannot be set to **N** position, contact an approved dealer.



When storing the tools, ensure they are securely replaced in the luggage compartment, in their original position.

Do not leave the tools unsecured inside the vehicle as they may be projected during braking.

Battery: breakdown recovery

To avoid all risk of sparks:

- Ensure that any power consumers (courtesy lights, etc.) are switched off before disconnecting or reconnecting a battery;
- when charging, switch off the charger before connecting or disconnecting the battery;
- do not place metal objects on the battery as this could create a short circuit between the terminals;
- always wait at least one minute after the engine has been switched off before disconnecting a battery;
- make sure that you reconnect the battery terminals after refitting.

BREAKDOWN RECOVERY



Before carrying out any action in the engine compartment, you must switch off the ignition

→ 149 or → 151.

Connecting a battery charger

The battery charger must be compatible with a battery with nominal voltage of 12 volts.

Do not disconnect the battery while the engine is running. **Follow the instructions given by the manufacturer of the battery charger you are using.**



Special procedures may be required to charge some batteries. Contact your approved dealer.

Avoid all risk of sparks which may cause an immediate explosion, and charge the battery in a well ventilated area.

Risk of serious injury.



Handle the battery with care as it contains sulphuric acid which must not come into contact

with the eyes or skin. If it does, wash the affected area with plenty of cold water. If necessary, consult a doctor.

Keep any flames, red hot objects or sparks away from the battery components (**risk of explosion**).

Please note when working close to the engine that it may be hot.

The engine cooling fan may also

start at any moment. The  label in the engine compartment reminds you of this.

Risk of injury.

Starting the vehicle using the battery from another vehicle

If you have to use the battery on another vehicle to start your vehicle, obtain suitable jump leads (with a large cross section) from an approved dealer or, if you already have jump leads, ensure that they are in perfect condition.

The two batteries must have an identical nominal voltage: 12 V. The battery supplying the current should have a capacity (amp-hours, Ah) which is at least the same as that of the discharged battery.

Ensure that there is no risk of contact between the two vehicles (risk of short circuiting when the positive terminals are connected) and that the discharged battery is properly connected. Switch off your vehicle ignition.

Start the engine of the vehicle supplying the current and run it at an intermediate engine speed.

Note: on the Hybrid version, as the battery cannot be directly accessed, it is necessary to use the remote terminals located in the engine compartment.



Do not use your Hybrid vehicle to restart a "12 Volt" battery in another vehicle.

The electrical power in the secondary "12 V" battery of an Hybrid vehicle is not sufficient for this operation.

Risk of damage to the vehicle.

BREAKDOWN RECOVERY



Handle the battery with care as it contains sulphuric acid which must not come into contact with the eyes or skin. If it does, wash the affected area with plenty of cold water. If necessary, consult a doctor.

Keep any flames, red hot objects or sparks away from the battery components (**risk of explosion**). Please note when working close to the engine that it may be hot. The engine cooling fan may also

start at any moment. The  label in the engine compartment reminds you of this.

Risk of injury.

"12 V" battery in the engine compartment

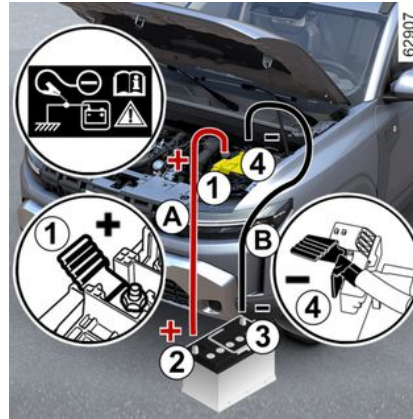

(combustion version)

Attach the positive cable (+) **A** to the terminal (+) **1** of the discharged battery, then to the terminal (+) **2** of the battery supplying the current.

Connect the negative cable (-) **B** to the terminal (-) **3** of the battery supplying the current then to the terminal (-) **4** of the discharged battery.

Start the engine as normal. As soon as it starts running, disconnect cables **A** and **B** in the reverse order (**4 - 3 - 2 - 1**).



Ensure that there is no contact between cables **A** and **B** and that positive cable **A** is not in contact with any metallic component in the vehicle supplying the current.

Risk of serious injury and/or damage to the vehicle.



Depending on the vehicle, in the event of a battery fault (disconnected, discharged battery, etc.), a reset of the power-assisted steering must be carried out → **122**.

BREAKDOWN RECOVERY

The secondary "12 V" battery at the rear of the vehicle

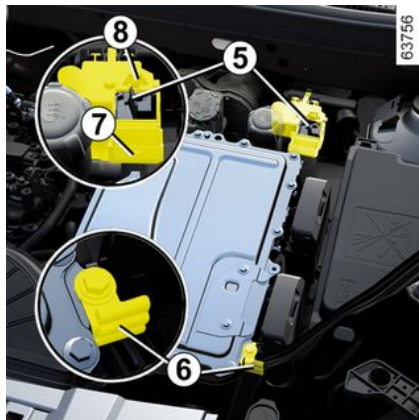

(Hybrid version)

The battery is not directly accessible.

Use the **terminal 5 (+)** and the **terminal 6 (-)** in the engine compartment.

Note: open the cover **7** of the terminal **5 (+)** by pressing the button **8**.

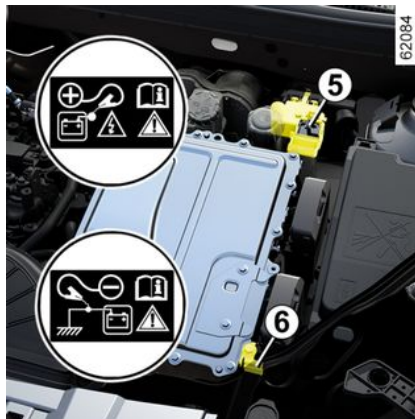

It is forbidden to disconnect the positive cable in the engine compartment.

Risk of the engine starting inadvertently.
Risk of burns by projection of sparks.

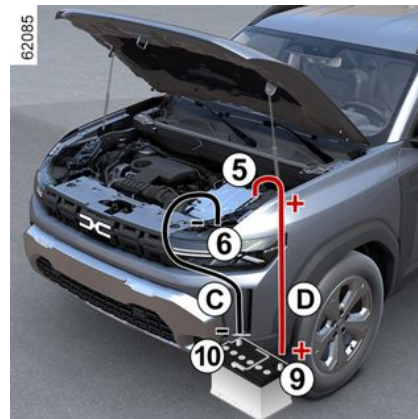

Attach the positive cable **D** to the **terminal 5 (+)**, then to the **terminal 9 (+)** of the battery supplying the current.

Attach the negative cable **C** to the **terminal 10 (-)** of the battery supplying the current, then to terminal **6 (-)**.

Press the brake pedal and the Start button. Once the engine has started, disconnect cables **C** and **D** in the reverse order (**6 - 10 - 9 - 5**).

After each operation of the cover **7**, check the terminal block cover on its tab **8**.

BREAKDOWN RECOVERY



Ensure that there is no contact between cables *C* and *D* and that the positive cable *D* is not in contact with any metallic component in the vehicle supplying the current.

Risk of injury and/or damage to the vehicle.

HEADLIGHTS, LIGHTS: REPLACING BULBS

Exterior lighting: replacing bulbs

Front headlights: replacing the bulbs



Main beam headlight 1

(depending on the vehicle)

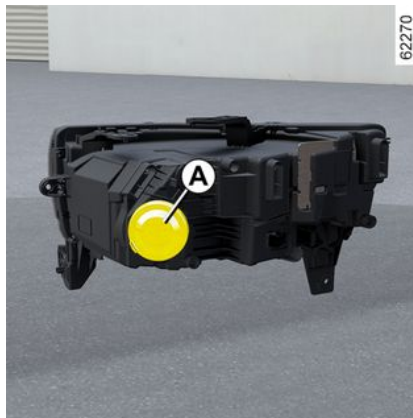

Remove the cover **A**.



Unclip the connector **2**, remove the assembly from its housing and take out the bulb.

Bulb type: H7.

Before replacing the bulb, make a careful note of its position in its housing. After changing it, check that the replacement bulb is in exactly the same position in the housing. Clip the cover in place.

Dipped beam headlight 2 (LED)

(depending on the vehicle)

Consult an approved Dealer.

Daytime running light/side light 3 (LED)

(depending on the vehicle)

Consult an approved Dealer.

Direction indicator light 4 (LED)

(depending on the vehicle)

Consult an approved Dealer.

HEADLIGHTS, LIGHTS: REPLACING BULBS



Please note when working close to the engine that it may be hot. The engine cooling fan may also start at any moment. The



label in the engine compartment reminds you of this.

Risk of injury.

Rear lights: changing bulbs

Direction indicator lights / brake and side lights



Open the luggage compartment lid and remove the cover **A**.

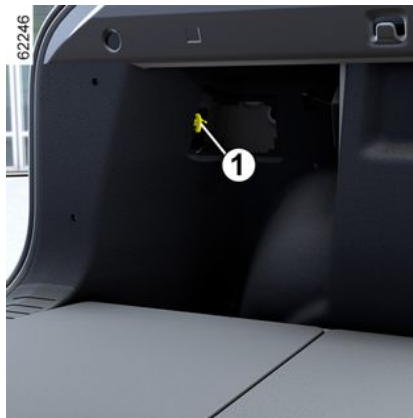

Unscrew the nut **1** and take out the light unit **2** from the outside.

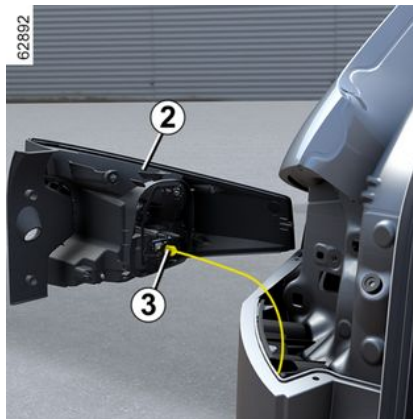

Release the connector **3** and unlock the clips **4** to remove the bulb holder **5**.

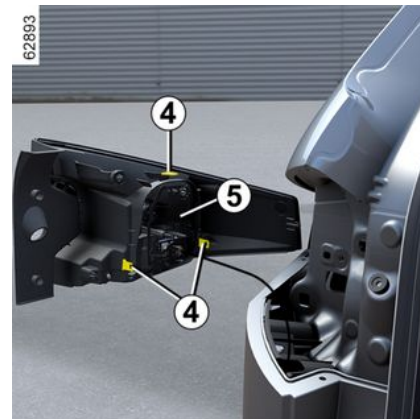

To comply with current legislation, or as a precaution, you can obtain an emergency kit from your approved dealer containing a set of spare bulbs and fuses.

HEADLIGHTS, LIGHTS: REPLACING BULBS



The bulbs are under pressure and may break when replaced.

Risk of injury.



Do not touch the exhaust.

Risk of burns.

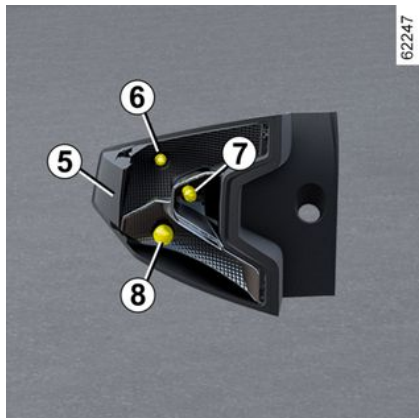

6. Side light

Bulb type: W5W.

7. Direction indicator lights

Bulb type: WY16W.

8. Side light and brake light

Bulb type: P21/5W.

Refitting

To re-fit, proceed in the reverse order taking care not to damage the wiring, tighten nut **1** first.



Reversing light 9

(depending on the vehicle)

Access the bulb holder located under the rear bumper, then unscrew it by turning towards the centre of the vehicle and remove the bulb.

Bulb type: P21W.

Refitting

To refit, proceed in the reverse order, taking care not to damage the wiring. Once the bulb has been replaced, check that it is properly secured.

However, because of their reduced accessibility, **we advise you to have your bulbs replaced by an Approved Dealer.**



High-level brake light LED 10

Consult an approved Dealer.

HEADLIGHTS, LIGHTS: REPLACING BULBS

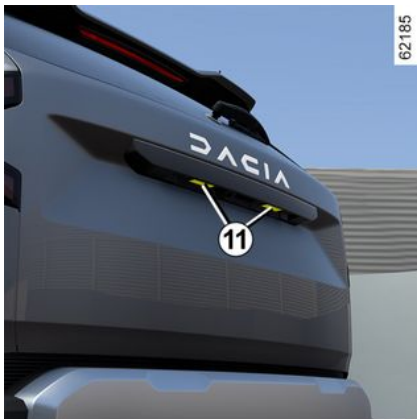

Number plate light 11 (LED)

(depending on the vehicle)
Consult an approved Dealer.



The bulbs are under pressure and may break when replaced.

Risk of injury.

Fog lights: changing bulbs

Front fog lights



Replace the left-hand front fog lights 1

(depending on the vehicle)

- Access the bulb holder by unclipping the flap 2;
- turn the bulb holder by a quarter of a turn;
- remove the bulb.

or

- Unscrew the screw using a screw-driver;
- access the bulb holder by unclipping the flap 2;

- turn the bulb holder by a quarter of a turn;
- remove the bulb.



Replace the right-hand front fog lights 3

Because of their reduced accessibility, **we advise you to have your bulbs replaced by an approved Dealer.**

(depending on the vehicle)

- Turn the steering wheel fully to the left;
 - unscrew the wheel arch fasteners;
 - turn the bulb holder by a quarter of a turn;
 - remove the bulb.
- or

HEADLIGHTS, LIGHTS: REPLACING BULBS

- Unscrew the screw using a screwdriver;
- access the bulb holder by unclipping the flap 4;
- turn the bulb holder by a quarter of a turn;
- remove the bulb.

Bulb type: H16.



The bulbs are under pressure and may break when replaced.

Risk of injury.

Refitting

To refit, proceed in the reverse order, taking care not to damage the wiring.

Once the bulb has been replaced, check that it is properly secured.

However, **we would advise you to have these bulbs replaced by an Approved Dealer.**



To comply with local legislation, or as a precaution, you can obtain an emergency kit containing a set of spare bulbs and fuses from an approved dealer.



Please note when working close to the engine that it may be hot. The engine cooling fan may also start at any moment. The



label in the engine compartment reminds you of this.

Risk of injury.

Rear fog light 5

(depending on the vehicle)



Access the bulb holder located under the rear bumper, then unscrew it by

turning towards the centre of the vehicle and remove the bulb.

Bulb type: P21W.



Do not touch the exhaust.

Risk of burns.

Refitting

To refit, proceed in the reverse order, taking care not to damage the wiring.

Once the bulb has been replaced, check that it is properly secured.

However, because of their reduced accessibility, **we advise you to have your bulbs replaced by an approved Dealer.**



The bulbs are under pressure and may break when replaced.

Risk of injury.

HEADLIGHTS, LIGHTS: REPLACING BULBS



Any operation on (or modification to) the electrical system must be performed by an approved Dealer since an incorrect connection might damage the electrical equipment (harness, components and in particular the alternator). In addition, your Dealer has all the parts required for fitting these units.

Indicator lights: changing bulbs



As the door mirror shell needs to be removed, **we advise you to have the**

bulb replaced by an approved dealer.

To access the bulb:

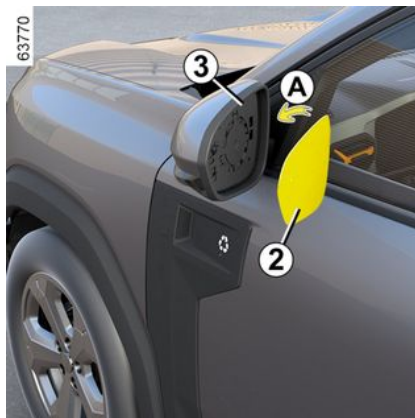

– carefully unclip the door mirror shell **2** from its base **3** (movement **A**);

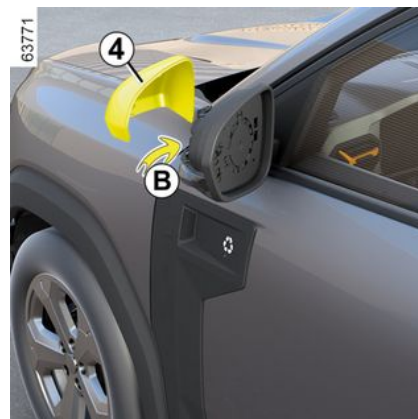

– unclip the shell **4** using a flat-blade screwdriver or similar (movement **B**);



6

HEADLIGHTS, LIGHTS: REPLACING BULBS

– unscrew the screws **5** using a screwdriver;



– unclip the cover **6** of the repeater **1** to access the lamp;

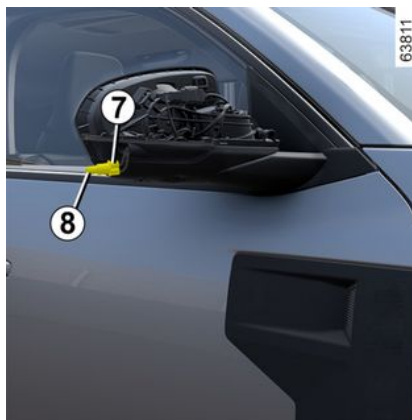

– turn the lamp holder **7** and pull out the bulb **8**.

Bulb type: WY5W.

To refit it, carry out the above operations in reverse order.

Make sure:

- that the bulb holder **7** is aligned correctly before inserting it into its housing;
- that the door mirror shell **2** clips properly onto its base **3**.

When disassembling and refitting, ensure that the wiring and the surrounding components are not damaged.



The bulbs are under pressure and may break when replaced.
Risk of injury.

Interior lighting: changing bulbs

Front ceiling light **1**

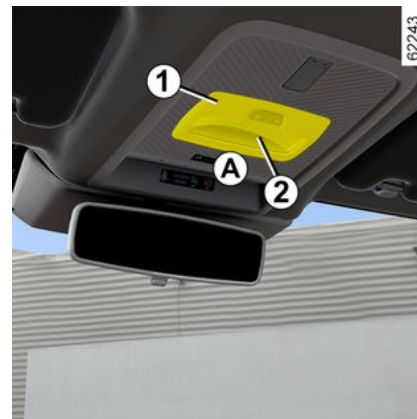

– Unclip the lens **2** using a tool such as a flat-head screwdriver positioned at area **A**;

HEADLIGHTS, LIGHTS: REPLACING BULBS

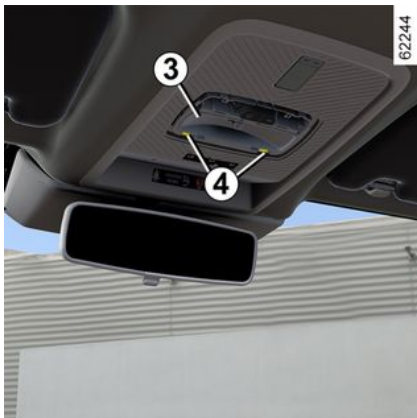

- unclip and release the bulb holder **3** using the tabs **4**;
- remove the bulb concerned.

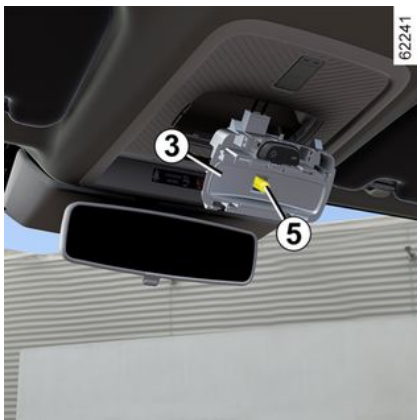

Bulb type 5: W5W.

Refitting

- Clip the lens **2** onto the bulb holder **3**;



- clip in the courtesy light **1** until you hear the click;
- ensure that the courtesy light is properly positioned and locked into place.



The bulbs are under pressure and may break when replaced.
Risk of injury.

Front reading spot lights **6**

(depending on the vehicle)

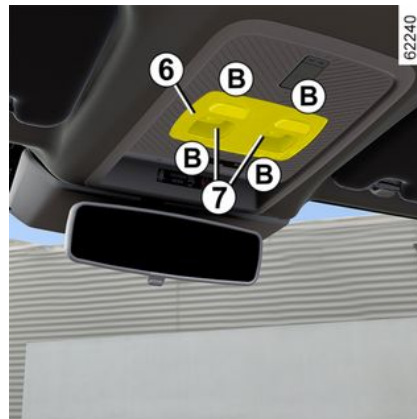

- Unclip the lens **7** using a tool such as a flat-head screwdriver positioned at area **B**;

HEADLIGHTS, LIGHTS: REPLACING BULBS

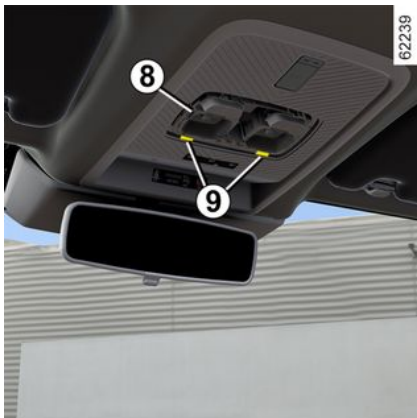

- 6**
- unclip and release the bulb holder **8** using the tabs **9**;
 - remove the bulb concerned.

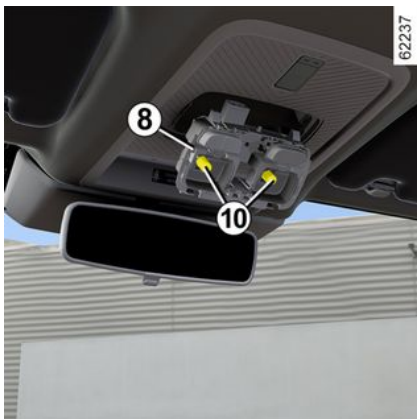

Bulb type 10: W5W.

Refitting

- Clip the lens **7** onto the bulb holder **8**;



- clip in the reading spot light unit **6** until it clicks;
- make sure that the reading spot lights block is correctly positioned and locked into place.

Rear reading spot light **11**

(depending on the vehicle)



- Unclip the lens **12** using a tool such as a flat-head screwdriver positioned at area **C**;

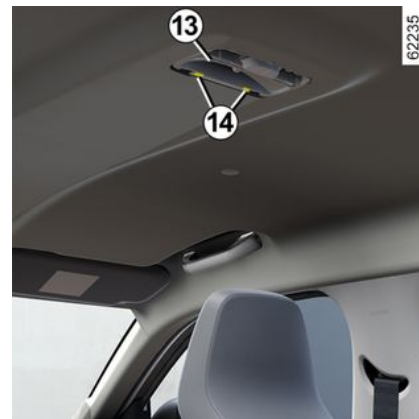

HEADLIGHTS, LIGHTS: REPLACING BULBS

- unclip and release the bulb holder **13** using the tabs **14**;
- remove the bulb concerned.



Bulb type 15: W5W.

Refitting

- Clip the lens **12** onto the bulb holder **13**;



- clip in the reading spot light unit **11** until you hear the click;
- make sure that the reading spot lights block is correctly positioned and locked into place.



The bulbs are under pressure and may break when replaced.
Risk of injury.

Glovebox light **16**

(depending on the vehicle)

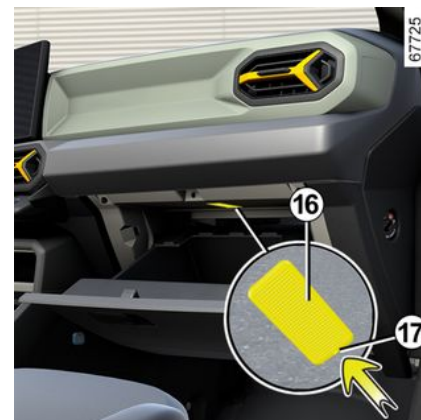

Unclip the light **16** using a flat-blade screwdriver or similar tool, pressing on the tab **17** to move the light towards the inside of the glovebox.

Disconnect the light.

Bulb type: W5W.

HEADLIGHTS, LIGHTS: REPLACING BULBS

Luggage compartment light 18

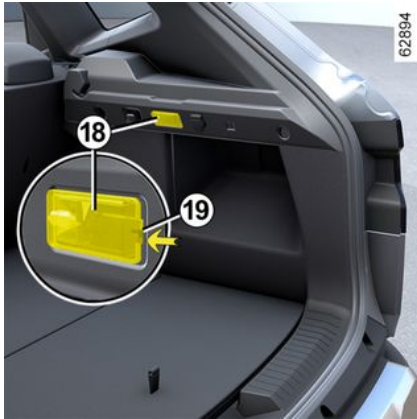

6

Unclip the light **18** by using a flat-blade screwdriver or similar tool to press on the tab **19** to move the light towards the inside of the luggage compartment.

Disconnect the light.

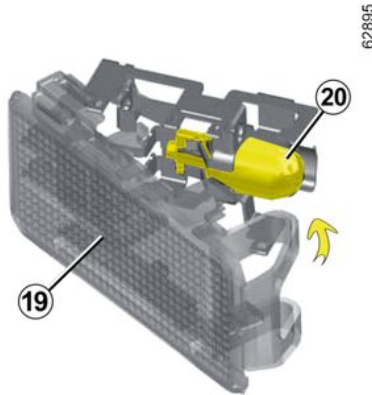

Release the lens **19** and access the bulb **20**.

Bulb type 20: W5W.



The bulbs are under pressure and may break when replaced.

Risk of injury.

WIPER BLADES: REPLACEMENT

Windscreen wiper blades 2

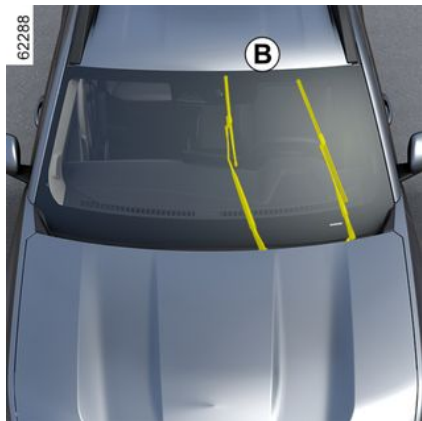

To replace the wipers, first put them in the service position **B**.



With the ignition on and the engine stopped:

- move the stalk **1** twice in succession to position **A** (single sweep): the wiper blades will stop in the service position **B** away from the bonnet;
- press the button **4** then remove the blade upwards.

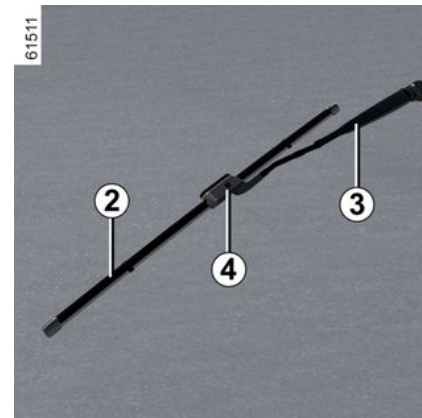

Refitting

To refit the wiper blade **2**, insert it into its housing in the arm **3**, then clip it in until you hear a click. Make sure that the blade is correctly locked in position.

To return the blades to the lowered position, make sure that the blades are folded down onto the windscreen then set the stalk **1** to position **A** (single sweep): the windscreen wiper blades will fold into the bonnet when the ignition is switched on.

WIPER BLADES: REPLACEMENT

 Check the condition of the wiper blades. You are responsible for their service

life:

- clean the blades and the windscreen regularly with soapy water;
- do not use them when the windscreen is dry;
- separate them from the windscreen when they have not been used for a long time.

The stalk in the off position (deactivated):

- lift the wiper arm **6**;
- rotate the rear screen wiper blade **5** (movement **C**) until it unclips;
- release the rear screen wiper blade **5** by pulling it.

Refitting

To refit the wiper blade, proceed in the reverse order to removal. Make sure that the blade is correctly locked in position.

 Check the condition of the wiper blades. You are responsible for their service

life:

- clean the blades and the windscreen regularly with soapy water;
- do not use them when the windscreen is dry;
- separate them from the windscreen when they have not been used for a long time.



– In frosty weather, make sure that the wiper blades are not stuck by ice (to avoid the risk of the motor overheating).

– Check the condition of the wiper blades.

Replace the wiper blades as soon as they begin to lose efficiency (approximately once a year).

Whilst changing the blade, take care not to drop the arm onto the window after it has been removed as this may break the window.



Before changing the rear wiper blade, make sure the stalk is in the off position (deactivated).

Risk of injury.

6 Replacing the rear screen wiper blade 5

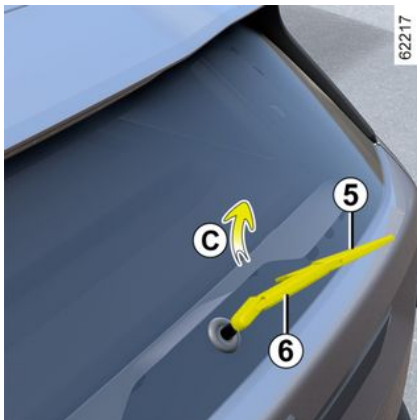

FUSES

Fuse box



If any electrical component does not work, check the condition of the fuses. Unclip the flap **A** using the notch **1** or, depending on the vehicle, unclip the flap **B** using the notch **2**.

Tweezers 3

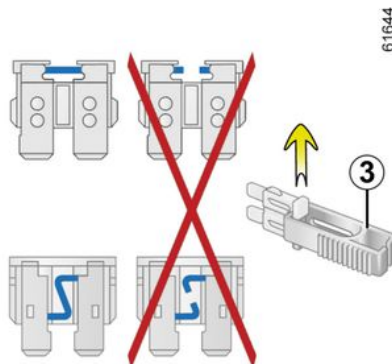

Detach the fuse using the tweezers **3**, located on the back of flap **A** or **B**.

To remove the fuse from the tweezers, slide the fuse to the side.

It is not advisable to use the free fuse locations.

 To comply with current legislation, or as a precaution, you can obtain an emergency kit from your approved dealer containing a set of spare bulbs and fuses.

 Check the fuse in question and **replace it**, if necessary, **with a fuse of the same rating**.
If a fuse is fitted with too high a rating, it may cause the electrical circuit to overheat (risk of fire) in the event of an item of equipment using an excessive amount of current.

FUSES

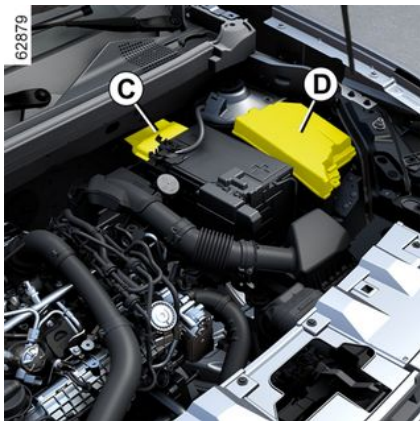

Fuses in the engine compartment *C* and *D*

Some functions are protected by fuses located in the engine compartment in units *C* and *D*.

However, because of their reduced accessibility, **we advise you to have your fuses replaced by an approved Dealer.**



When working in the engine compartment, ensure that the windscreen wiper stalk is in the park position.

Risk of injury.

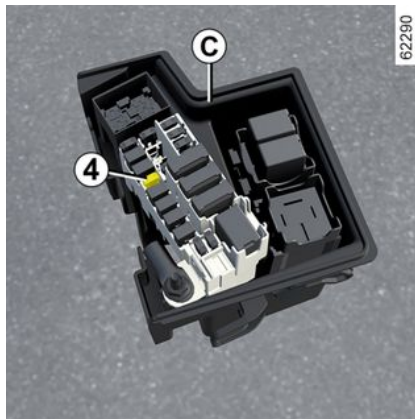

LPG fuse in the engine compartment *C*.

LPG fuse *4*: LPG circuit shut-off.



The engine must be switched off and not put on standby before any operation is carried out in the engine compartment.

You must switch off the ignition
➔ 149 ➔ 151.



Please note when working close to the engine that it may be hot. The engine cooling fan may also start at any moment. The



label in the engine compartment reminds you of this.

Risk of injury.

FUSES

Allocation of fuses

(the presence of certain fuse depends on the vehicle equipment level)

64824

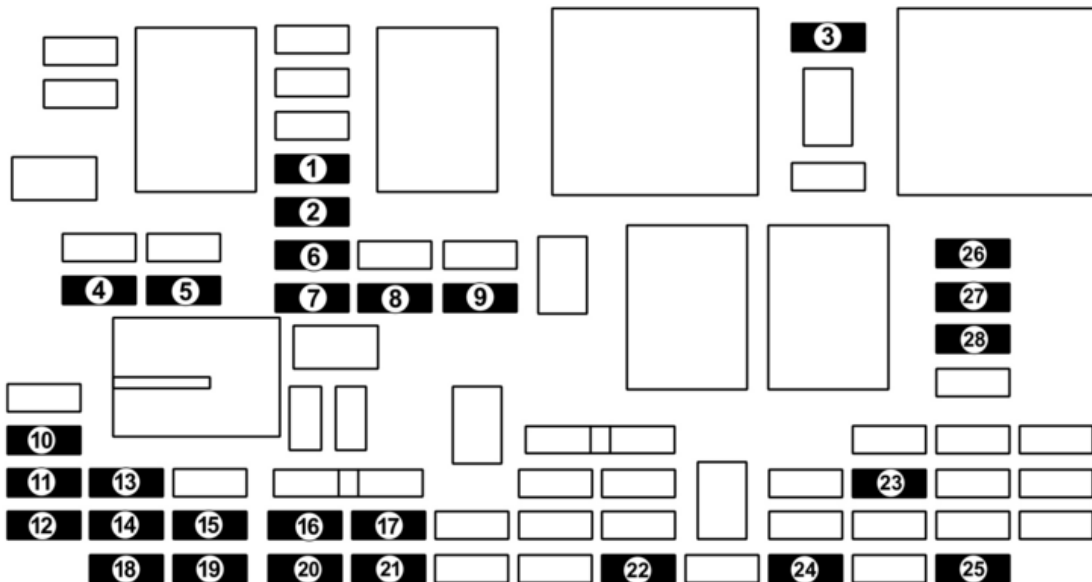

FUSES

- 1.** Heated rear view mirrors
- 2.** Driver's and passenger's heated seat
- 3.** Trailer traction
- 4.** Rear wiper and rear fog lights
- 5.** Hazard warning lights without MCB
- 6.** Brake lights without MCB
- 7.** Radio
- 8.** Rear screen de-icing
- 9.** 4x4 button, Manual air conditioning, Radio, ECU Gateway, Interior rear view mirror, Seat belt, Heated windscreen
- 10.** USB
- 11.** Luggage compartment accessories socket, towing device
- 12.** Depending on the vehicle, heated seats
- 13.** Hazard warning lights with MCB
- 14.** Brake lights with MCB
- 15.** One-touch windows for the front passenger seat
- 16.** USB
- 17.** Rear view mirror control
- 18.** One-touch windows for the rear right-hand seat
- 19.** One-touch windows
- 20.** One-touch windows for the rear left-hand seat
- 21.** External and internal welcome sound
- 22.** Courtesy light
- 23.** Assisted parking button
- 24.** Pre-equipment for accessories
- 25.** Pre-equipment for accessories
- 26.** 12 V socket, Cigarette lighter
- 27.** Heated steering wheel
- 28.** Windscreen washer liquid pump switch

FITTING A RADIO

If your vehicle is not fitted with an audio system, one can be fitted and locations have been provided for:



– the radio **1**;



– the front speakers **2** and **3**;



– the rear speakers **4**.

To install any equipment, please consult an approved dealer.

Radio location **1**

Unclip the blanking cover. The connections (aerial, + and - supply, speaker wiring) are located behind it.

- i** – In all cases, follow the manufacturer's instructions carefully.
- – The specifications of the brackets and wires (available from our network) vary depending on the equipment level of your vehicle and the type of radio. Consult an approved Dealer to find out the correct part number.
 - No work may be carried out on the vehicle's electrical or radio circuits, except by approved dealers: an incorrectly connected system may result in damage to the electrical equipment and/or the components connected to it.

INSTALLATION AND USE OF ACCESSORIES



Electrical and electronic accessories

Before installing this type of accessory (particularly for transmitters/receivers: frequency bandwidth, power level, position of the aerial, etc.), make sure it is compatible with your vehicle. Contact an approved Dealer.

Before connecting an accessory to a socket, please ensure that it does not exceed the maximum power authorised for the socket → 283 → 293. **Fire hazard.**

No work may be carried out on the vehicle's electrical and/or electronic circuits, except by a qualified professional. In fact, an incorrect connection and/or the installation of electrical/electronic accessories not approved by the manufacturer could lead to:

- damage to the electrical and/or electronic equipment;
- damage to the components connected to it;
- the collection and use of vehicle data;
- an invasion of privacy (modification, deletion or unwarranted access to personal data);
- cancellation of the authorisation for entry into service.

Risk of serious accidents. Risk of invasion of privacy.

If you have electrical equipment fitted in future, make sure that you are notified of the rating and position of the corresponding fuse.

Using the diagnostic socket

The use of electronic accessories on the diagnostic socket may cause serious disturbance to the vehicle's electronic systems and/or cause invasion of privacy (modification, deletion or unwarranted access to personal data). For your safety, we recommend that you only use electronic accessories approved by the manufacturer: consult an approved dealer. **Risk of serious accidents. Risk of invasion of privacy.**

Fitting aftermarket accessories

If you wish to install accessories on the vehicle: consult an approved dealer. Also, to ensure the correct operation of your vehicle, and to avoid any risk to your safety, we recommend that you use only accessories specifically designed for your vehicle, which are the only accessories for which the manufacturer will provide a warranty.

If you are using an anti-theft device, only attach it to the brake pedal.

Driver obstruction

INSTALLATION AND USE OF ACCESSORIES

On the driver's side, only use mats suitable for the vehicle, attached with the pre-fitted components, and check the fitting regularly. Do not lay one mat on top of another. **There is a risk of wedging the pedals.**

OPERATING FAULTS

The following advice will enable you to carry out quick, temporary repairs. For safety reasons you should always contact an approved dealer as soon as possible.

Using the card	POSSIBLE CAUSES	ACTION REQUIRED
The card does not lock or unlock the doors.	Card battery is flat.	Replace the battery. You will still be able to lock/unlock, and start your vehicle → 49 → 40 → 151.
	Use of appliances operating on the same frequency as the card (mobile phone, etc.).	Stop using the devices or use the built-in key → 49.
	Vehicle located in a high electromagnetic radiation zone.	Use the key that is built into the card → 49.
	Vehicle battery flat.	
	The "Place card on zone + START" message appears on the instrument panel.	Place your card on the symbol → 151 then press the start button.
	The vehicle is started.	While the engine is on, it is not possible to lock/unlock using the card. Turn off the ignition.
Desynchronisation of the card.	Unlock the driver's door by inserting the card's built-in key into the door lock → 49, then place the card on the symbol → 151 and press the start button to synchronise the card.	

Using the remote control	POSSIBLE CAUSES	ACTION REQUIRED
The remote control does not lock or unlock the doors.	The remote control battery is flat.	Use the emergency key.
	Use of appliances operating on the same frequency as the remote control (mobile phone, etc.).	Stop using the devices or use the key.

OPERATING FAULTS

Using the remote control	POSSIBLE CAUSES	ACTION REQUIRED
	Vehicle located in a high electromagnetic radiation zone. Discharged battery.	Replace the battery. You will still be able to lock, unlock, and start your vehicle → 49 → 45 → 149.
	The vehicle is started.	While the engine is on, it is not possible to lock/unlock using the key. Turn off the ignition.
	Desynchronisation of the remote control.	Unlock the driver's door by inserting the key into the door lock → 49, then start the engine to synchronise the remote control → 149.

6

The starter is activated	POSSIBLE CAUSES	ACTION REQUIRED
The instrument panel indicator lights are weak or fail to light up and the starter does not turn.	Battery terminals not tight, battery terminals disconnected or oxidised.	Retighten, reconnect or clean them if they are oxidised.
	Discharged battery or not operational.	Connect another battery to the faulty battery → 341 or replace the battery if necessary. Do not push the vehicle if the steering column is locked.
	Faulty circuit.	Consult an approved Dealer.
The engine will not start.	Starting conditions are not fulfilled.	Please see the paragraph on → 148 → 149 → 151.
	The "hands-free" card does not work.	→ 151.
With the vehicle stationary, engine cold, the engine's idle speed is high.	Petrol version, this is not necessarily a fault. This may be caused by the increase in the engine temperature.	The engine's idle speed should decrease after about one minute. Otherwise, this may be caused by another fault. Consult an approved Dealer.

OPERATING FAULTS

The starter is activated	POSSIBLE CAUSES	ACTION REQUIRED
The engine cannot be switched off.	Card not detected.	Place your card on the symbol → 151 then press the start button.
	Electronic fault.	Press the starter button quickly five times.
The steering column remains locked.	Steering wheel locked.	Move the steering wheel while pressing the engine start button (or, depending on the vehicle, while using the ignition key) → 149 → 151 .
	Faulty electrical circuit.	Consult an approved Dealer.

On the road	POSSIBLE CAUSES	ACTION REQUIRED
Vibrations.	Tyres not inflated to the correct pressure, incorrectly balanced or damaged.	Check the tyre pressure. If this is not the cause, have their condition checked by an approved dealer.
White smoke from the exhaust.	In the diesel version, this is not necessarily a fault. Smoke may be caused by particle filter regeneration.	→ 165 .
	Petrol version, this is not necessarily a fault. Depending on the climate conditions (cold, humidity etc.), smoke may be produced under hard vehicle acceleration.	Reduce the engine speed and avoid sudden acceleration to gradually make the smoke disappear. Otherwise, this may be caused by another fault. Consult an approved Dealer.
Smoke under the bonnet.	Short-circuit or cooling system leak.	Stop, switch off the ignition, stand away from the vehicle and contact an approved dealer.
The oil pressure warning light comes on: while cornering or braking	The level is too low.	Add engine oil → 308 .

OPERATING FAULTS

On the road	POSSIBLE CAUSES	ACTION REQUIRED
is slow to go out or remains lit up under acceleration	Loss of oil pressure.	Stop the vehicle and contact an approved dealer.
Steering becomes heavy.	Assistance overheating. Fault with the electric assistance motor. Fault in the assistance system.	Drive carefully at reduced speed, be aware of the level of force in the steering wheel needed to turn the wheels. Consult an approved Dealer.
The engine is overheating. The coolant temperature indicator is in the warning zone and warning light STOP comes on.	Engine cooling fan not working. Coolant leaks.	Stop the vehicle, switch off the engine and contact an approved dealer. Check the coolant reservoir: it should contain fluid. If there is no coolant, consult an approved dealer as soon as possible.
Coolant boiling in the coolant reservoir.	Mechanical fault: damaged cylinder head gasket.	Stop the engine. Call an approved dealer.



Radiator: in the event of a significant lack of coolant, remember that you must never top up using cold coolant while the engine is very hot. After any procedure on the vehicle which has involved even partial draining of the cooling system, it must be refilled with a new mixture prepared in the correct proportions. Reminder: only products approved by our Technical Department may be used for this purpose.

OPERATING FAULTS

Electrical equipment	POSSIBLE CAUSES	ACTION REQUIRED
The wipers do not work.	Wiper blades stuck.	Separate the blades from the windscreen before using the wipers.
	Faulty electrical circuit.	Consult an approved Dealer.
	Fuse damaged.	Replace the fuse or have it replaced → 359.
The wiper does not stop.	Faulty electrical controls.	Consult an approved Dealer.
Direction indicators flashing more quickly.	Faulty rear bulb.	→ 346
The indicators are not working.	Faulty electrical circuit or control.	Consult an approved Dealer.
	Fuse damaged.	Replace the fuse or have it replaced → 359.
The headlights do not switch on or off.	Faulty electrical circuit or control.	Consult an approved Dealer.
	Fuse damaged.	Replace the fuse or have it replaced → 359.
Traces of condensation in the headlights or rear lights.	<p>Traces of condensation may be a natural phenomenon caused by variations in temperature and humidity.</p> <p>In this case, the traces will disappear slowly once the lights are switched on.</p>	
The front seat belt reminder warning light comes on when the seat belts are fastened.	An object is stuck between the floor and the seat and is disrupting the operation of the sensor.	Remove all objects from underneath the front seats.

INFORMATION ABOUT THE VEHICLE

Vehicle identification plate

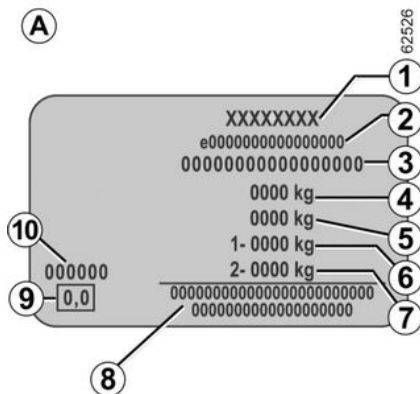
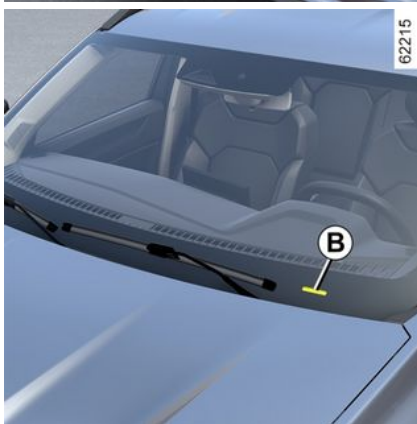

Quote the details given on identification plate **A** on all letters or orders.

The presence and location of the information depends on the vehicle.

Manufacturer's plate **A**

1. Manufacturer name.
2. EC design number or approval number.
3. Identification number.

Depending on the vehicle, this information is also provided on marking **B**.

4. MMAC (Maximum permissible all-up weight).

5. MTR (Gross Train Weight: vehicle fully loaded, with trailer).

6. MMTA (Maximum Permissible Weight) front axle.

7. MMTA rear axle.

8. Area reserved for related or additional entries.

9. Diesel exhaust emissions.

Depending on the vehicle, this information may not be indicated on the manufacturer's plate but on the engine smoke opacity label → 165.

10. Paint reference (colour code).

Technical Information for the emergency services

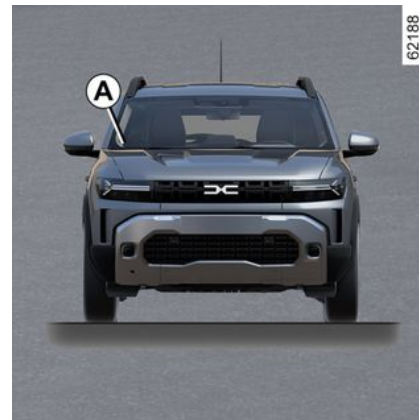

INFORMATION ABOUT THE VEHICLE

The QR Code on label **A** allows emergency workers to use a tablet or smartphone to immediately access technical information that is useful for working on the vehicle in the event of an accident.

Ensure that the label **A** is always visible and present on the windscreen as well as the rear screen.

Any modification or damage would prevent access to the information.

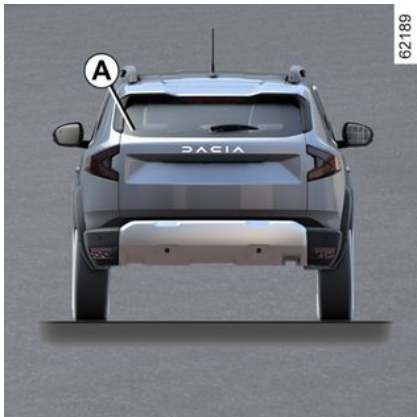

Engine identification, engine specifications

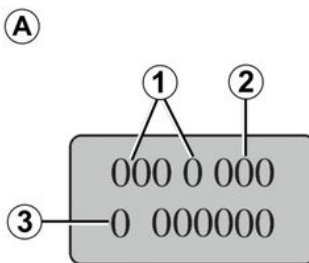

Please quote the engine identification information in area A in all correspondence or orders.

(Location varies depending on engine)

1. Engine type.
2. Engine suffix.
3. Engine serial number.



INFORMATION ABOUT THE VEHICLE

67712



1.3 TCe

Hybrid version

67710

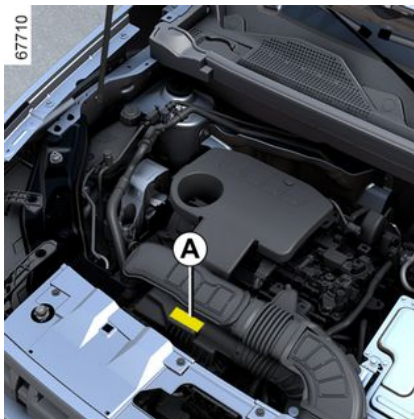

62887

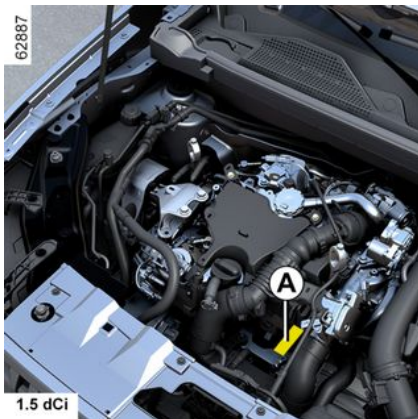

1.5 dCi

67733



7

INFORMATION ABOUT THE VEHICLE



Engine specifications

Versions	1.0 TCe	1.2 TCe	1.3 TCe	Hybrid			1.5 dCi
Engine type (see engine plate)	H4Dt	H5Ft	H5H	H4M	H5P	5DH	K9K Turbo
Cubic capacity (cc)	999	1 198	1 332	1 598	1 793	-	1 461
Type of fuel Octane rating	Petrol It is essential to use unleaded petrol with an octane rating matching that indicated on the label affixed on the fuel filler flap ➔ 138 .					-	Diesel The label located in the fuel filler flap indicates the authorised fuels.
Spark plugs	Only use the spark plugs specified for your vehicle's engine. The type should be marked on a label stuck inside the engine compartment. If it is not then contact your approved Dealer. Fitting spark plugs which are not to specification may damage the engine.					-	-

INFORMATION ABOUT THE VEHICLE

Ver- sions	1.0 TCe	1.2 TCe	1.3 TCe	Hybrid			1.5 dCi
Engine type (see en- gine plate)	H4Dt	H5Ft	H5H	H4M	H5P	5DH	K9K
Cubic capac- ity (cc)	999	1 198	1 332	1 598	1 793	-	1 461
Fuel types that meet European standards and are compatible with the engines of vehicles sold in Europe (in any other case, contact an Ap-	<p style="text-align: center;">(E5)</p> <p style="text-align: center;">Unleaded petrol compliant with standard EN 228 containing up to 5% ethanol in volume.</p>			-			<p style="text-align: center;">(B7)</p> <p style="text-align: center;">Diesel fuel compliant with standard EN 590 containing up to 7% fatty acid methyl ester in volume.</p> <p style="text-align: center;">(B10)</p> <p style="text-align: center;">Diesel fuel compliant with standard EN 16734 containing up to 10% fatty acid methyl ester in volume.</p>

INFORMATION ABOUT THE VEHICLE

Ver- sions	1.0 TCe	1.2 TCe	1.3 TCe	Hybrid	1.5 dCi
proved Dealer).	 Unleaded petrol compliant with standard EN 228 containing up to 10% ethanol in volume.			-	 Parrafinic Diesel fuel compliant with standard EN 15940 containing up to 7% fatty acid methyl ester in volume.

INFORMATION ABOUT THE VEHICLE

Dimensions (in metres)

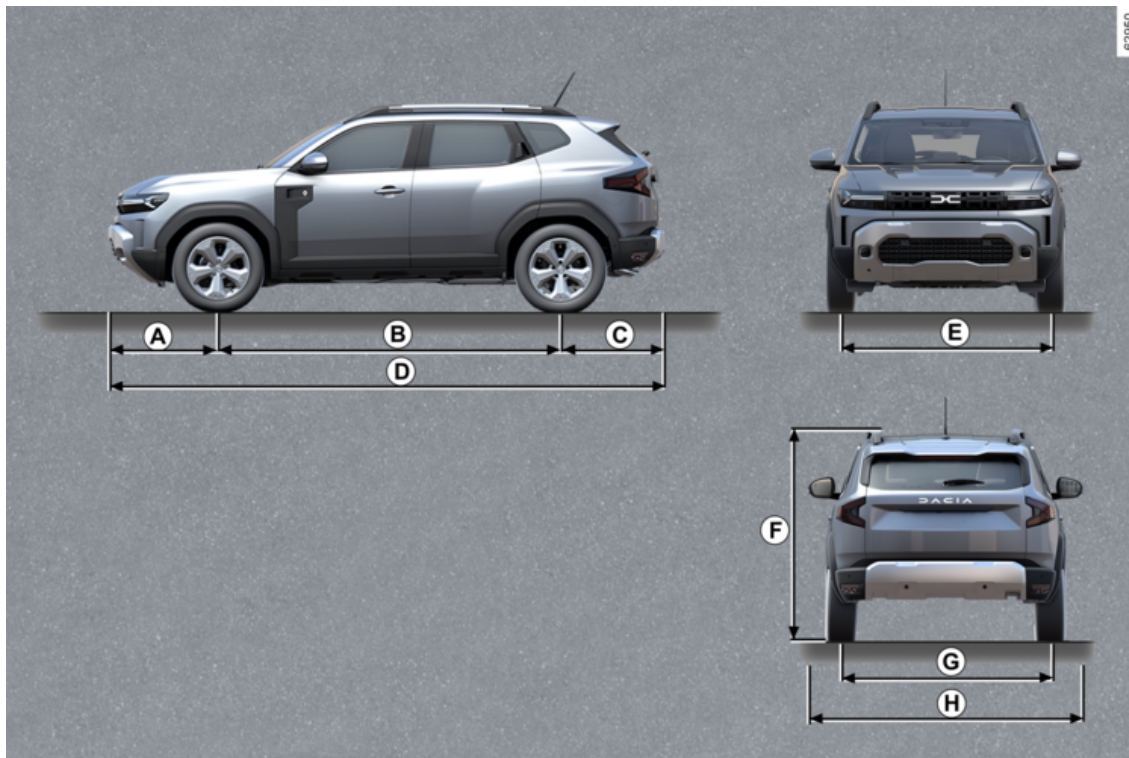

7

INFORMATION ABOUT THE VEHICLE

	Dimensions
A	0,864
B	2,658
C	0,823
D	4,345
E	1.555 to 1.580
F	1.661 unladen, with roof bars
G	1.545 to 1.565
H	1.921 to 2.069 – 2.069 with door mirrors folded out – 1.921 with door mirrors folded in

INFORMATION ABOUT THE VEHICLE

Weights (in kg)

The weights indicated are for a basic vehicle without options: they vary depending on your vehicle's equipment. Consult an approved dealer.

Versions	4x2	4x4
Maximum Permissible All-Up Weight (MMAC) Gross Train Weight (GTW)	Weights indicated on the manufacturer's plate → 372.	
Braked Trailer Weight*	found by calculating: MTR - MMAC	
Unbraked trailer weight*	670 kg	745 kg
Permissible nose weight*	75 kg	
Maximum permissible load on roof with a carrying device	80 kg (including the carrying device)	

*Towing weight (towing a caravan, boat, etc.)

Towing is prohibited when the MTR - MMAC calculation is equal to zero, or when the MTR is equal to zero (or is not listed) on the manufacturer's plate.

- It is important to comply with the towing weights, governed by local legislation in each country and, in particular, laid down in the Road Traffic Regulations. Contact an approved Dealer for any modifications to towing equipment.
- For vehicles fitted with a trailer, **the gross train weight (vehicle + trailer) must never be exceeded.** However the following is tolerated:
 - rear axle MMTA exceeded by no more than 15%;
 - exceeding the MMAC by no more than 10% or 100 kg (whichever limit is reached first).

In either case, the maximum speed of the vehicle and trailer must not exceed 50 mph (80 km/h) and the tyre pressure must be increased by 0.2 bar (3 PSI).

- The engine output and climbing capability are reduced with altitude. We recommend that the maximum load be reduced by 10% at an altitude of 1,000 metres and by an additional 10% for each 1,000 metres thereafter.

Weight transfer (versions 4x2 only)

If the Maximum Permissible All-up Weight of the vehicle has not been reached, up to 300 kg can be transferred to the braked trailer, within the limits of the Gross Train Weight.

REPLACEMENT PARTS AND REPAIRS

Original parts are based on very stringent specifications and are subjected to specific tests. Therefore, they are of at least the same level of quality as the parts fitted originally.

If you always fit genuine replacement parts to your vehicle, you will ensure that it performs well. Furthermore, repairs carried out in the approved dealer network with original parts are guaranteed according to the conditions stated on the back of the repair order.

SERVICE SHEETS

VIN:

Date:	Miles (km):	Invoice number:	Comments/miscellaneous
Type of operation: Service <input type="checkbox"/> <input type="checkbox"/>		Stamp	
Anticorrosion check: OK <input type="checkbox"/> Not OK* <input type="checkbox"/>			
Date:	Miles (km):	Invoice number:	Comments/miscellaneous
Type of operation: Service <input type="checkbox"/> <input type="checkbox"/>		Stamp	
Anticorrosion check: OK <input type="checkbox"/> Not OK* <input type="checkbox"/>			
Date:	Miles (km):	Invoice number:	Comments/miscellaneous
Type of operation: Service <input type="checkbox"/> <input type="checkbox"/>		Stamp	
Anticorrosion check: OK <input type="checkbox"/> Not OK* <input type="checkbox"/>			

7

* See specific page

SERVICE SHEETS

VIN:

Date:	Miles (km):	Invoice number:	Comments/miscellaneous
Type of operation: Service <input type="checkbox"/> <input type="checkbox"/>		Stamp	
Anticorrosion check: OK <input type="checkbox"/> Not OK* <input type="checkbox"/>			
Date:	Miles (km):	Invoice number:	Comments/miscellaneous
Type of operation: Service <input type="checkbox"/> <input type="checkbox"/>		Stamp	
Anticorrosion check: OK <input type="checkbox"/> Not OK* <input type="checkbox"/>			
Date:	Miles (km):	Invoice number:	Comments/miscellaneous
Type of operation: Service <input type="checkbox"/> <input type="checkbox"/>		Stamp	
Anticorrosion check: OK <input type="checkbox"/> Not OK* <input type="checkbox"/>			

* See specific page

SERVICE SHEETS

VIN:

Date:	Miles (km):	Invoice number:	Comments/miscellaneous
Type of operation:		Stamp	
Service <input type="checkbox"/>			
..... <input type="checkbox"/>			
Anticorrosion check:			
OK <input type="checkbox"/> Not OK* <input type="checkbox"/>			
Date:	Miles (km):	Invoice number:	Comments/miscellaneous
Type of operation:		Stamp	
Service <input type="checkbox"/>			
..... <input type="checkbox"/>			
Anticorrosion check:			
OK <input type="checkbox"/> Not OK* <input type="checkbox"/>			
Date:	Miles (km):	Invoice number:	Comments/miscellaneous
Type of operation:		Stamp	
Service <input type="checkbox"/>			
..... <input type="checkbox"/>			
Anticorrosion check:			
OK <input type="checkbox"/> Not OK* <input type="checkbox"/>			

* See specific page

7

SERVICE SHEETS

VIN:

Date:	Miles (km):	Invoice number:	Comments/miscellaneous
Type of operation: Service <input type="checkbox"/> <input type="checkbox"/>		Stamp	
Anticorrosion check: OK <input type="checkbox"/> Not OK* <input type="checkbox"/>			
Date:	Miles (km):	Invoice number:	Comments/miscellaneous
Type of operation: Service <input type="checkbox"/> <input type="checkbox"/>		Stamp	
Anticorrosion check: OK <input type="checkbox"/> Not OK* <input type="checkbox"/>			
Date:	Miles (km):	Invoice number:	Comments/miscellaneous
Type of operation: Service <input type="checkbox"/> <input type="checkbox"/>		Stamp	
Anticorrosion check: OK <input type="checkbox"/> Not OK* <input type="checkbox"/>			

* See specific page

SERVICE SHEETS

VIN:

Date:	Miles (km):	Invoice number:	Comments/miscellaneous
Type of operation:		Stamp	
Service <input type="checkbox"/>			
..... <input type="checkbox"/>			
Anticorrosion check:			
OK <input type="checkbox"/> Not OK* <input type="checkbox"/>			
Date:	Miles (km):	Invoice number:	Comments/miscellaneous
Type of operation:		Stamp	
Service <input type="checkbox"/>			
..... <input type="checkbox"/>			
Anticorrosion check:			
OK <input type="checkbox"/> Not OK* <input type="checkbox"/>			
Date:	Miles (km):	Invoice number:	Comments/miscellaneous
Type of operation:		Stamp	
Service <input type="checkbox"/>			
..... <input type="checkbox"/>			
Anticorrosion check:			
OK <input type="checkbox"/> Not OK* <input type="checkbox"/>			

* See specific page

SERVICE SHEETS

VIN:

Date:	Miles (km):	Invoice number:	Comments/miscellaneous
Type of operation: Service <input type="checkbox"/> <input type="checkbox"/>		Stamp	
Anticorrosion check: OK <input type="checkbox"/> Not OK* <input type="checkbox"/>			
Date:	Miles (km):	Invoice number:	Comments/miscellaneous
Type of operation: Service <input type="checkbox"/> <input type="checkbox"/>		Stamp	
Anticorrosion check: OK <input type="checkbox"/> Not OK* <input type="checkbox"/>			
Date:	Miles (km):	Invoice number:	Comments/miscellaneous
Type of operation: Service <input type="checkbox"/> <input type="checkbox"/>		Stamp	
Anticorrosion check: OK <input type="checkbox"/> Not OK* <input type="checkbox"/>			

* See specific page

ANTICORROSION CHECK

If the continuation of the warranty is subject to repair, it is indicated below.

VIN:

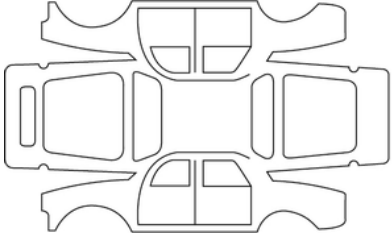
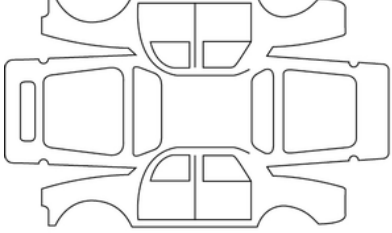
Date of repair:		Stamp
Corrosion repair operation to be carried out:		
Date of repair:		Stamp
Repair to be carried out:		

7

ANTICORROSION CHECK

If the continuation of the warranty is subject to repair, it is indicated below.

VIN:

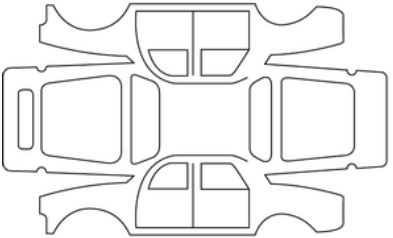
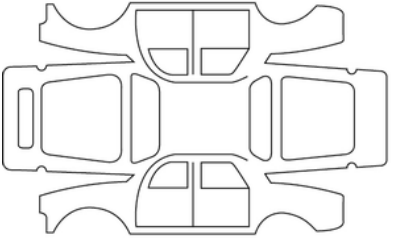
Date of repair:		Stamp
Corrosion repair operation to be carried out:		
Date of repair:		Stamp
Repair to be carried out:		

ANTICORROSION CHECK

If the continuation of the warranty is subject to repair, it is indicated below.

VIN:

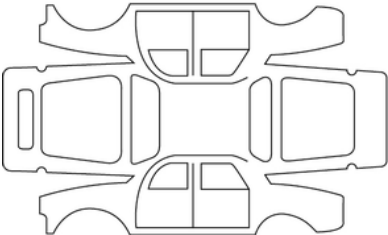
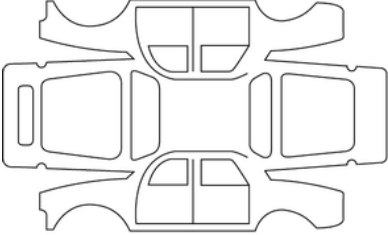
Date of repair:		Stamp
Corrosion repair operation to be carried out:		
Date of repair:		Stamp
Repair to be carried out:		

7

ANTICORROSION CHECK

If the continuation of the warranty is subject to repair, it is indicated below.

VIN:

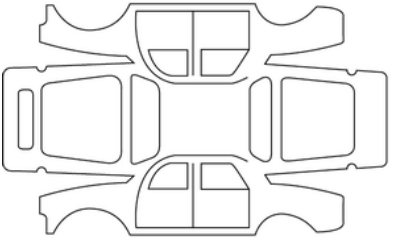
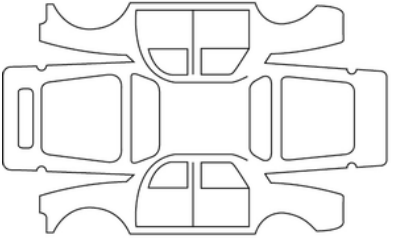
Date of repair:		Stamp
Corrosion repair operation to be carried out:		
Date of repair:		Stamp
Repair to be carried out:		

ANTICORROSION CHECK

If the continuation of the warranty is subject to repair, it is indicated below.

VIN:

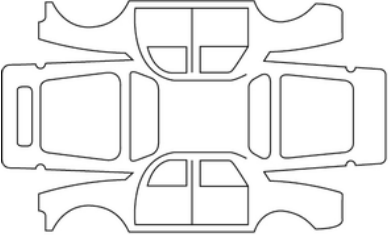
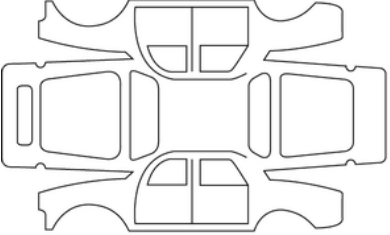
Date of repair:		Stamp
Corrosion repair operation to be carried out:		
Date of repair:		Stamp
Repair to be carried out:		

7

ANTICORROSION CHECK

If the continuation of the warranty is subject to repair, it is indicated below.

VIN:

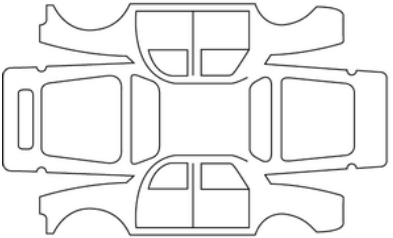
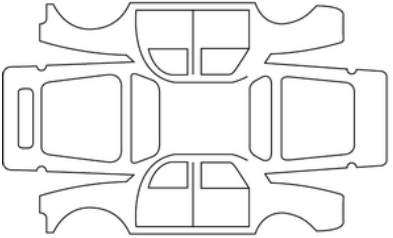
Date of repair:		Stamp
Corrosion repair operation to be carried out:		
Date of repair:		Stamp
Repair to be carried out:		

ANTICORROSION CHECK

If the continuation of the warranty is subject to repair, it is indicated below.

VIN:

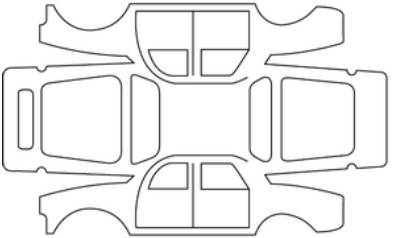
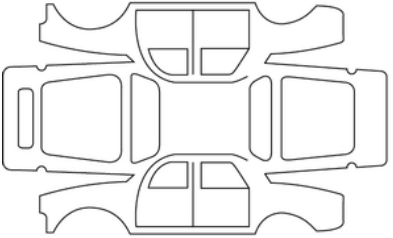
Date of repair:		Stamp
Corrosion repair operation to be carried out:		
Date of repair:		Stamp
Repair to be carried out:		

7

ALPHABETICAL INDEX

Symbols

"Hands-free" card: battery, [40](#)

"Hands-free" card: use, [37](#)

12 V battery, [318](#)

4-wheel drive (4WD), [189](#)

A

ABS, [195](#)

Accessing the vehicle, [48](#)

Accessories socket, [293](#)

Access to the engine compartment, [307](#)

Adaptive cruise control, [240](#)

Additional lights, [349](#)

Additional methods of restraint, [71](#)

Additive (reagent), [144](#)

Additive tank capacity, [144](#)

Adjusting the front seats, [54](#)

Adjusting your driving position, [59](#), [59](#)

Airbag, [63](#), [68](#), [68](#), [71](#)

Airbag : activating the front passenger airbag, [90](#)

Airbag : deactivating the front passenger airbag, [90](#)

Airbag inflatable cushion, [71](#)

Airbags : child safety, [90](#)

Air conditioning, [272](#), [273](#), [273](#), [277](#), [277](#), [280](#), [280](#)

Air conditioning: information and advice for use, [280](#)

Air conditioning ventilation, [272](#)

Air vents, [272](#)

Air Vents, [269](#)

Anti-corrosion protection, [320](#)

Anti-lock braking system: ABS, [195](#)

Anti-theft (switch), [148](#)

Armrest, [294](#)

Assistance: driving aid, [240](#)

Audible alarm: door or luggage compartment door open, [49](#)

Audible alarm: lights-on reminder, [49](#)

Audible and visual signals, [131](#)

Automatic gearbox (use), [159](#), [169](#)

Automatic gearbox selector lever, [159](#)

Automatic locking when driving, [52](#)

B

Battery, [316](#)

Battery: troubleshooting, [341](#)

Battery (remote control), [45](#)

Battery breakdown recovery, [341](#)

Blind spot: warning, [209](#)

Blind spot warning, [209](#)

Bonnet, [308](#)

Breakdown recovery towing, [339](#)

Bulbs replacement, [347](#), [349](#), [352](#)

C

Card, [48](#)

Card: battery, [40](#)

Card: emergency key, [35](#)

Card: engine not starting in hands-free mode, [35](#)

ALPHABETICAL INDEX

Card: hands-free, [35](#)
Card: locking/unlocking the opening elements, [35](#)
Card: use, [35](#), [37](#)
Catalytic converter, [167](#), [167](#)
Central door locking, [49](#)
Changing a wheel, [335](#)
Changing bulbs, [347](#), [349](#), [352](#)
Changing fuel while driving, [32](#)
Changing gears, [159](#)
Children, [48](#)
Children (safety), [288](#)
Child restraint, [73](#), [82](#), [86](#)
Child restraint devices, [73](#)
Child restraint system, [73](#), [82](#), [86](#)
Child safety, [43](#), [48](#), [73](#), [82](#), [86](#)
Child seat height adjustment, [73](#)
Child seats, [73](#), [79](#), [82](#), [86](#)
Cleaning: vehicle interior, [322](#)
Clock, [115](#), [115](#)
Closing the doors, [48](#), [49](#)
Configuration menu, [113](#)
Configuration menu settings, [113](#)
Control instruments, [98](#), [108](#), [115](#), [116](#), [126](#)
Control warning lights, [98](#), [108](#), [116](#)
Coolant level, [312](#)
Courtesy light, [290](#)
Cruise control, [237](#), [240](#), [241](#)
Cruise control - speed limiter, [234](#), [237](#), [241](#)

Customising the vehicle settings, [113](#)

D

De-icing/demisting the windscreen, [277](#)
Demisting the rear window, [277](#)
Detection of road signs: overspeed warning, [229](#)
Diesel filter, [138](#)
Display, [108](#)
Door locking remote control batteries, [45](#)
Doors, [48](#), [52](#)
Doors/luggage compartment door, [35](#)
Driver assistance, [209](#), [214](#), [229](#), [261](#)
Driver vigilance warning, [226](#)
Driving, [148](#), [149](#), [153](#), [159](#), [165](#), [167](#), [169](#), [177](#), [183](#), [189](#),
[195](#), [209](#), [214](#), [234](#), [237](#), [240](#), [241](#), [252](#), [261](#)
Driving advice, [177](#)
Driving aids, [113](#), [209](#), [214](#), [229](#), [240](#), [261](#)
Driving position, [93](#)
Driving position settings, [59](#)

E

ECO driving, [116](#), [177](#)
ECO mode, [177](#)
Electric windows, [288](#)
Electronic parking brake, [169](#)
Electronic stability program: ESC, [195](#)
Emergency brake assist, [195](#)
Emergency braking, [195](#)

ALPHABETICAL INDEX

Emergency call, [266](#)
Emergency key, [35](#)
Emergency spare wheel, [324](#), [333](#)
Emission control advice, [176](#), [176](#)
Engine oil, [308](#)
Engine oil dipstick, [308](#)
Engine oil grade, [309](#)
Engine oil level, [308](#), [309](#)
Engine start/stop button, [153](#)
Environment, [174](#)
ESC: Electronic stability program, [195](#)
Excessive speed warning, [229](#)
Exterior lighting and signals, [126](#)
Exterior lights, [346](#)
Exterior temperature, [115](#)

F

Filling with fuel, [138](#)
Filter: particle filter, [165](#)
Fitting a child seat, [79](#)
Fitting a radio, [364](#), [364](#)
Fittings, [294](#)
For child safety, [288](#)
Front armrest, [54](#)
Front seat adjustment, [54](#)
Front seats, [54](#)
Fuel consumption, [177](#)
Fuel economy, [177](#)

Fuel filler flap, [138](#)
Fuel grade, [138](#), [138](#)
Fuel priming bulb, [138](#)
Fuel tank, [138](#)
Fuel tank cap, [138](#)
Fuel tank capacity, [138](#)
Fuel Tips for reducing consumption, [177](#)
Fuses, [359](#)

G

Gear control, [159](#)
Gearstick, [159](#)
Glovebox, [294](#)
GPL, [32](#)
Grab handle, [292](#)

H

Handbrake, [159](#), [169](#)
Hands-free telephone integrated control, [283](#)
Hazard signal, [131](#)
Headlights, [126](#)
Headrests, [57](#)
Heated seats, [54](#), [57](#)
Heated steering wheel, [122](#)
Heated windscreen, [277](#)
Heating and air conditioning system, [269](#), [272](#), [273](#), [277](#)
Heating system, [269](#), [272](#), [273](#), [277](#), [280](#)
Hill start assistance, [195](#)

ALPHABETICAL INDEX

Horn, [131](#)

I

Ignition switch, [148](#), [169](#)

Indicators, [131](#)

Indicators: direction indicators, [131](#)

Instrument panel, [98](#), [108](#), [113](#), [116](#), [169](#)

Instrument panel warning lights, [98](#), [169](#)

Interior lighting, [290](#)

Interior lighting: changing bulbs, [352](#)

Interior trim maintenance, [322](#)

Isofix, [86](#)

J

Jack, [335](#)

Jets, [132](#)

K

Key/radio frequency remote control: use, [43](#)

Key/Remote control, [43](#)

Keys, [43](#)

L

Lane departure prevention, [201](#)

Levels, [307](#), [308](#), [314](#)

Levels: coolant, [312](#)

Lifting the vehicle Changing a wheel, [333](#), [335](#)

Lighting: interior, [290](#), [352](#)

Lighting signals, [126](#)

Lights: direction indicator lights, [131](#)

Lights: exterior, [126](#), [347](#), [349](#)

Lights: fog lights, [349](#)

Lights: hazard warning lights, [131](#)

Lights: replacing bulbs, [346](#)

Locking remote control, [43](#)

Locking the doors, [35](#), [37](#), [48](#)

LPG, [98](#), [138](#), [149](#), [153](#)

Luggage compartment, [53](#), [301](#)

M

Maintenance, [176](#)

Maintenance: bodywork, [320](#)

Maintenance: filters, [314](#)

Maintenance: interior trims, [322](#)

Maintenance: mechanical, [308](#), [314](#)

Messages on the instrument panel, [98](#), [169](#)

Methods of restraint in addition to the front seat belts, [63](#)

Mirrors, [292](#)

Multimedia equipment, [283](#)

Multimedia port(s), [283](#)

Multimedia screen screens, [209](#), [214](#), [261](#)

Multi-view camera, [261](#)

My Safety, [94](#), [96](#), [200](#), [201](#), [209](#), [226](#), [228](#)

N

Navigation, [283](#)

ALPHABETICAL INDEX

Navigation system, [283](#)

O

Oil change, [309](#)

Opening/closing opening elements, [48](#)

Opening elements, [48](#)

Opening elements - locking / unlocking, [48](#)

Opening the doors, [48](#), [49](#)

Operating faults, [71](#), [169](#), [169](#), [240](#)

Operating faults: card batteries, [35](#)

P

Paintwork maintenance, [320](#)

Parking brake, [169](#)

Parking distance control, [113](#), [252](#), [258](#)

Passenger safety: front passenger airbag, [90](#)

Pedestrian horn, [24](#)

Phone, [283](#)

Power: range, [177](#)

Power consumption, [108](#), [177](#), [179](#)

Power saving, [177](#)

Practical advice, [138](#), [324](#), [333](#), [335](#), [339](#), [347](#), [349](#), [352](#), [357](#),
[359](#), [364](#)

Pretensioners, [63](#)

Puncture, [333](#), [335](#)

Puncture: emergency spare wheel, [333](#)

Put the engine on standby, [155](#)

R

Radio, [283](#)

Radio pre-equipment, [364](#)

Reagent (tank), [144](#)

Reagent filling, [144](#)

Reagent grade, [144](#)

Reagent tank, [144](#)

Reagent tank cap, [144](#)

Reagent tank capacity, [144](#)

Rear bench seat, [57](#)

Rear parcel shelf, [300](#)

Rear seats, [57](#)

Rear seats functions, [57](#)

Rear view mirrors, [124](#)

Replacement and repair parts, [381](#)

Replacement bulbs, [347](#), [349](#), [352](#)

Replacing windscreen wiper blades, [357](#)

Restraint devices in addition to the rear seat belts, [68](#)

Restraint in addition to the seatbelts, [63](#), [68](#), [71](#)

Reversing camera, [258](#)

Reversing radar, [252](#)

Roof bars, [303](#)

Roof bars rack, [303](#)

Running in, [148](#)

S

Safe distance, [240](#)

Safe distance alert, [214](#)

ALPHABETICAL INDEX

Safe distances, [214](#)
SCR: selective catalytic reduction, [144](#)
Seat belt pretensioners, [68](#)
Seat belts, [59](#), [63](#), [68](#), [71](#), [322](#)
Selecting reverse gear, [159](#)
Settings, [113](#)
Side protection devices, [68](#), [68](#)
Speakers location, [364](#)
Special features of Diesel vehicles, [165](#)
Special features of GPL versions, [32](#)
Special features of petrol vehicles, [167](#)
Speed limiter, [234](#)
Spoiler, [303](#)
Spotlights, [290](#)
Starting, [149](#)
Starting the engine, [148](#), [149](#), [149](#), [153](#), [153](#), [155](#)
Steering wheel adjustment, [122](#)
Stop and Start, [155](#)
Stop and Start function, [155](#), [169](#)
Stopping the engine, [149](#), [169](#)
Storage compartment, [294](#)
Storage compartment/fittings: passenger compartment, [294](#)
Storage compartments, [294](#), [301](#)
Sun visor, [292](#)

T

Temperature regulation, [277](#), [280](#)
Towing rings, [339](#)

Traction battery range, [177](#)
Traction control, [195](#)
Transporting children, [73](#), [82](#), [86](#)
Trip computer, [98](#)
Troubleshooting: battery, [341](#)
Tyre inflation, [183](#), [327](#)
Tyre inflation kit, [331](#)
Tyre pressure, [183](#), [327](#)
Tyre pressure loss warning, [183](#)
Tyres, [183](#), [324](#), [327](#)

U

Unlocking the doors, [49](#)

V

Vehicle customisation settings, [113](#)
Vehicle range, [177](#)
Vehicle settings personalisation menu, [113](#)
Ventilation, [277](#), [280](#)
Ventilation air conditioning, [273](#)
Visual signals, [131](#)

W

Warning, [131](#)
Warning buzzer, [49](#)
Warning lights, [209](#)
Washing, [320](#)
Windows, [288](#)

ALPHABETICAL INDEX

Windscreen demisting, [277](#)

Windscreen washer, [132](#), [136](#)

Windscreen wiper blades, [357](#)

Wiper, [132](#), [136](#)

Wiper blades, [132](#), [357](#)

Wiper blades: replacement, [357](#)



7711416532

Réf 7711416532 / Edition anglaise
NU 1520-2 – 06/2024

